

# Printer cabinet

Product ID. Q7T05



Scan for Support  
[support@garvee.com](mailto:support@garvee.com)



Distributed by  
**GARVEE**.com

Product Display

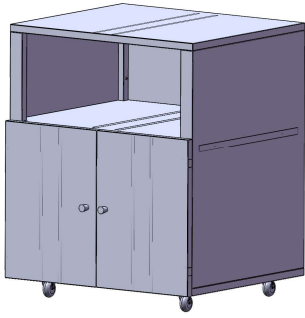

Product Structure Details

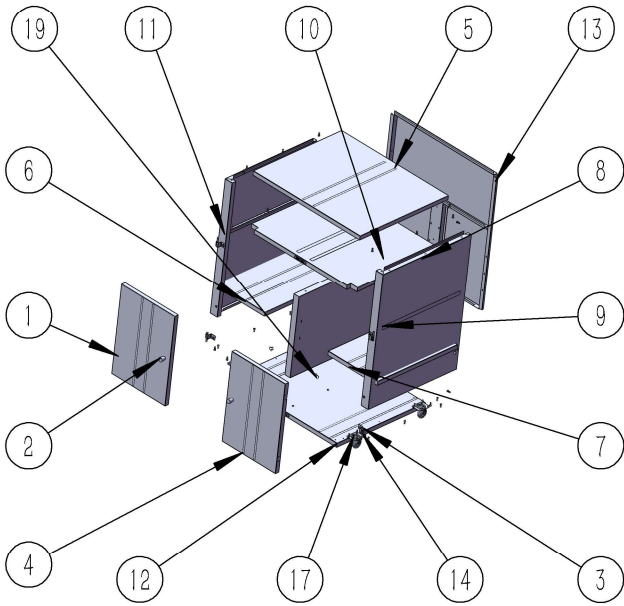

Assembly Steps

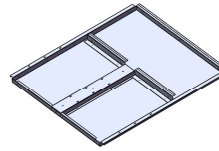

(Step-1)

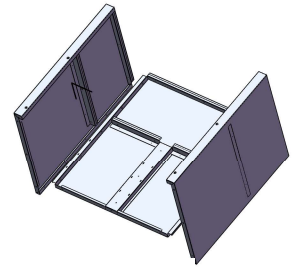

(Step-2)

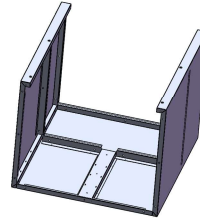

(Step-3)

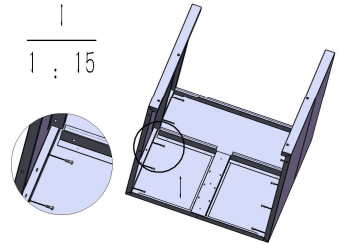

(Step-4)

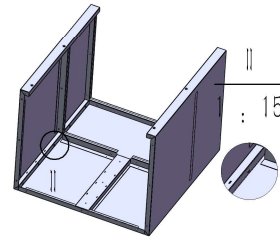

(Step-5)

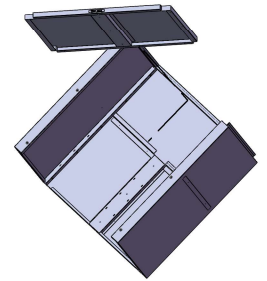

(Step-6)

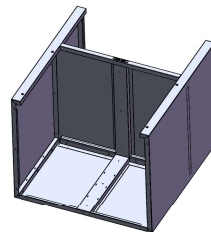

(Step-7)

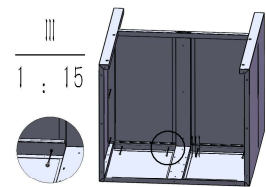

(Step-8)

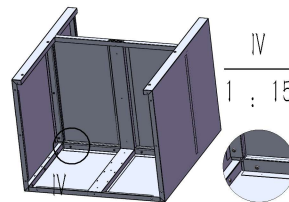

(Step-9)

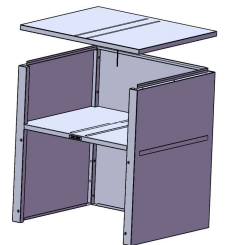

(Step-10)

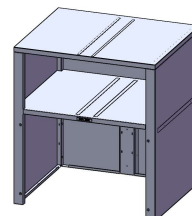

(Step-11)

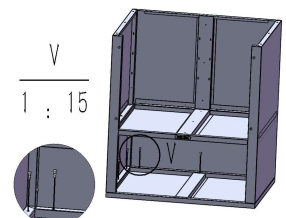

(Step-12)

Item Number	Part Number	Quantity
1	Door Assembly-2	1
2	Door Handle	2
3	Cylindrical Bolt	4
4	Door Component-1	1
5	Top Plate Component	1
6	Shelf Component-1	1
7	Shelf Component-2	1
8	Middle Layer Component	1
9	Right Side Panel Component	1
10	Vertical Middle Shelf Partition	1
11	Left Side Panel Component	1
12	Bottom Panel Component	1
13	Back Panel Component	1
14	<b>Hinge</b>	4
15	M5-12 Cross Slot Machine Screw	4
16	Cross Slot Pan Head Bolt M4-8	2
17	<b>Caster</b>	4
18	Cross Slot Round Head M5X15 Screw	67
19	Code Load	8

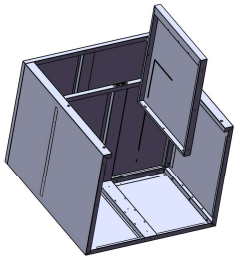

(Step-13)

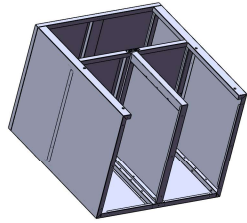

(Step-14)

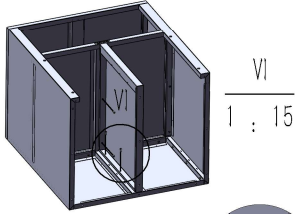

(Step-15)

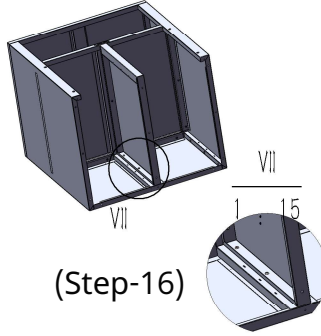

(Step-16)

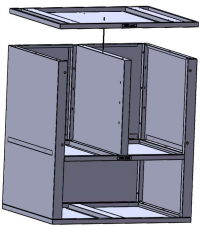

(Step-17)

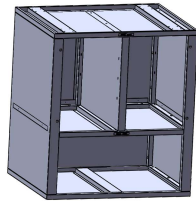

(Step-18)

VIII  
1 : 15

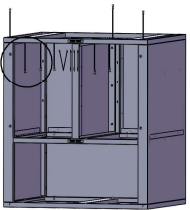

(Step-19)

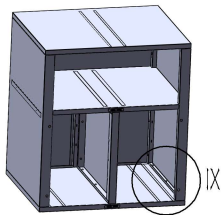
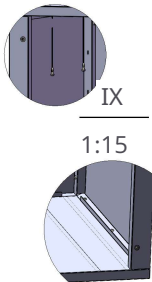

(Step-20)

X  
1 : 15

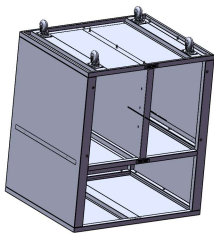

(Step-21)

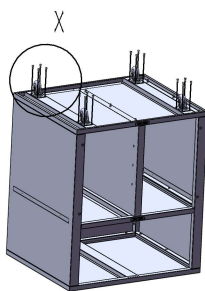
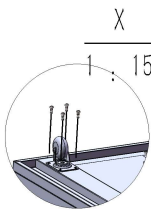

(Step-22)

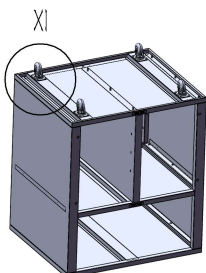

(Step-23)

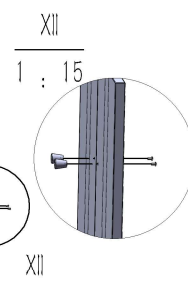
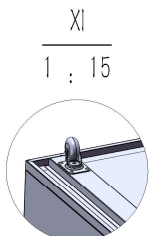

(Step-24)

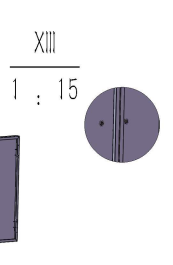

(Step-25)

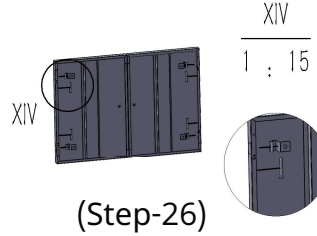

(Step-26)

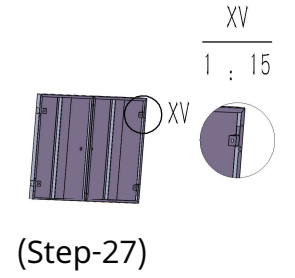

(Step-27)

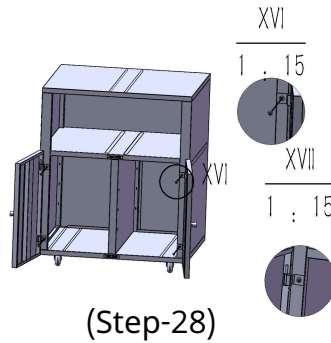

(Step-28)

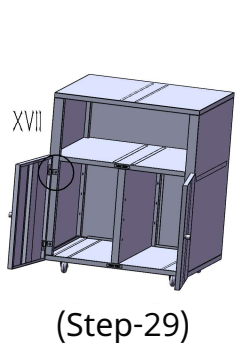

(Step-29)

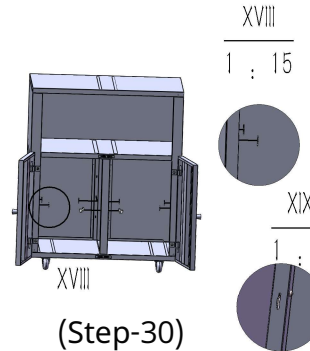

(Step-30)

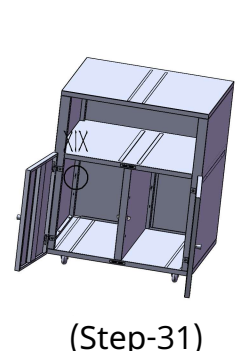

(Step-31)

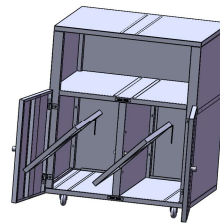

(Step-32)

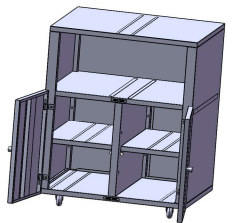

(Step-33)

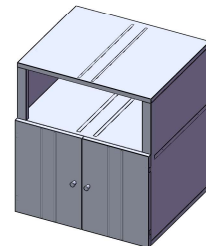

(Step-34)