

Top View

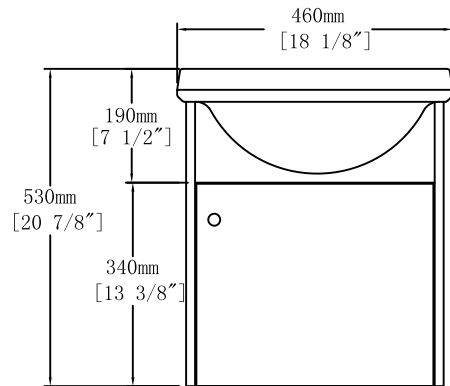

Front View

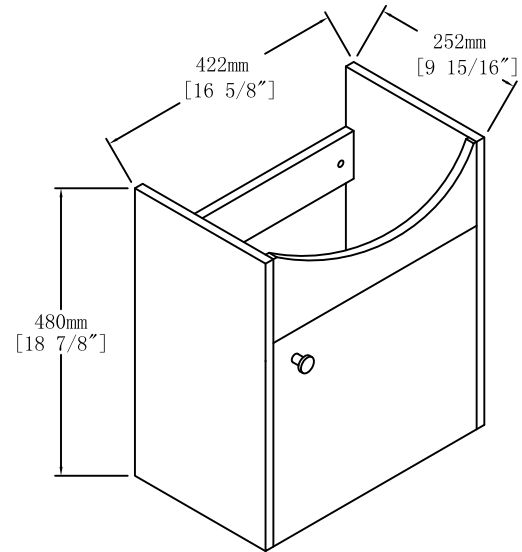
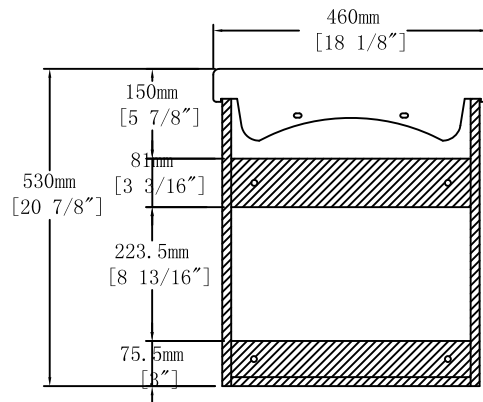

Back View

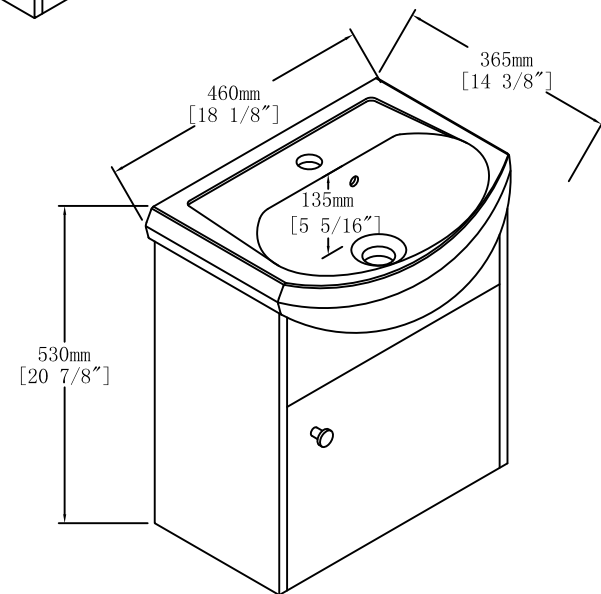

Item NO.	BV B02318	Version	V1
Projece		Date	2022-8-6