

JUMPKING[®]

Trampolines

User Guide

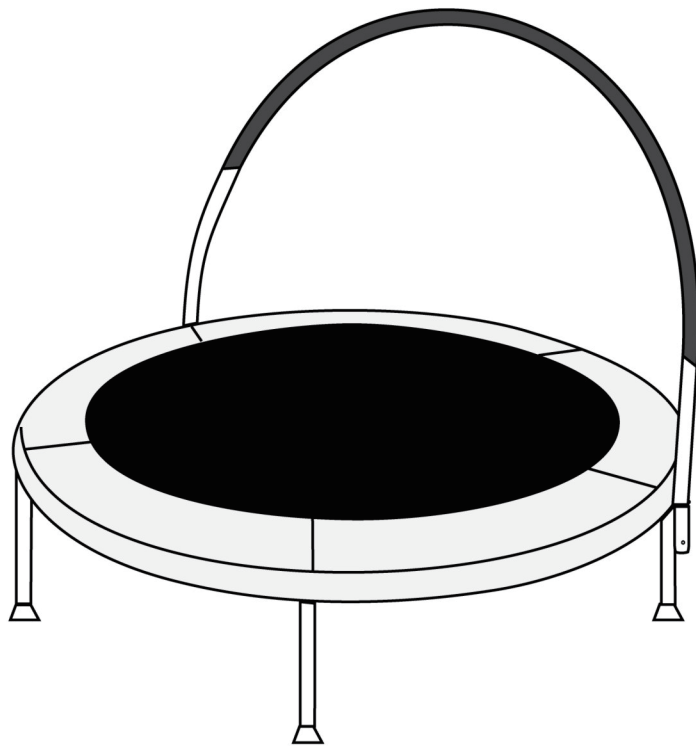

36in BOUNCER

Model# JK36IV

The trampoline is designed for users weighing 38kg (85lbs) or less.

**Got a Problem building your trampoline?
Please contact us at contact@jumpking.com**



WARNING: Read these assembly instructions carefully before attempting to assemble or use this product. Keep this user guide in a safe place for future reference.

JUMPKING® Trampolines

36in BOUNCER

Model# JK36IV

QUESTIONS?

If you have questions after reading this manual, please email us at contact@jumpking.com. Trained technicians will provide immediate assistance.

REPLACEMENT PARTS

To order replacement parts, please visit our website at www.jumpking.com.

More detailed instructions on assembling your trampoline will be available on www.jumpking.com in the Manual and Assembly section.

CONTENTS

IMPORTANT PRECAUTIONS	3
PART LIST	5
ASSEMBLY	6
CARE AND MAINTENANCE	12

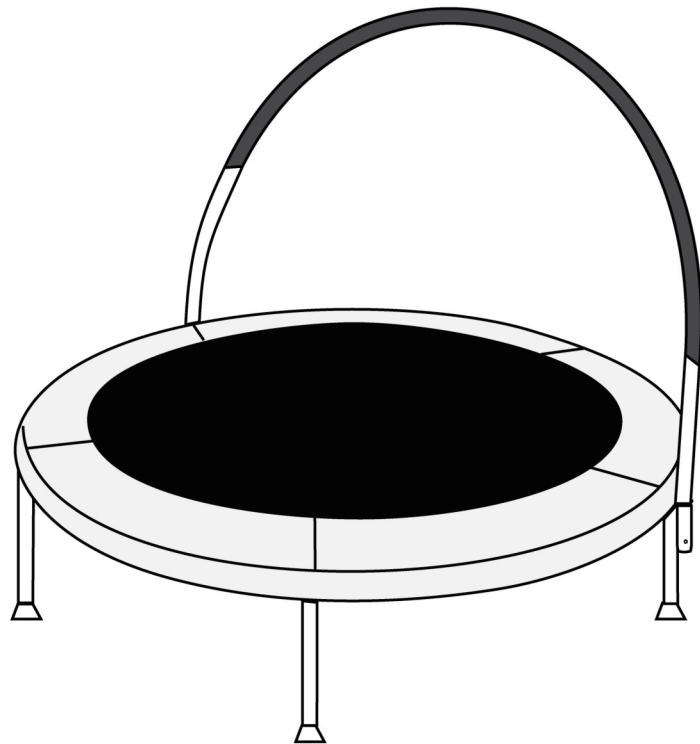

IMPORTANT PRECAUTIONS

⚠ WARNING: To reduce the risk of serious injury, read and follow all warnings, precautions, and instructions in this manual before assembling and using the trampoline.

This product is intended for use by children between 3-10 years of age.

This enclosure is to be used only in connection with this trampoline.

Read and follow all warnings and instruction.

This product is intended to be assembled by an adult.

Maximum weight limited 38 kg / 85 lbs.

Warning! Not suitable for children under 36 months. Small parts and long cords may be a choking and strangulation hazard.

BUILDING YOUR TRAMPOLINE

1. This is a 2 person build.
2. Time for build is approximately 1 hour.

WHAT YOU WILL NEED

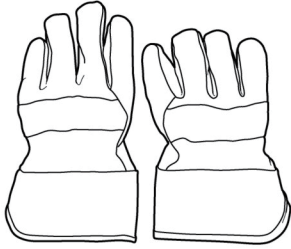

Description:
Gloves

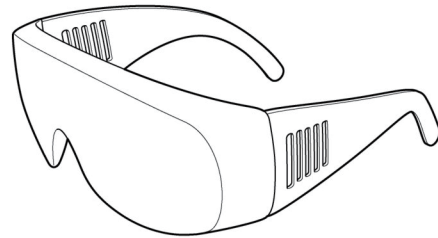



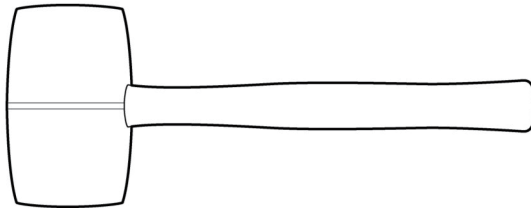





Description:
Safety glasses

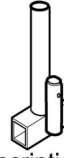
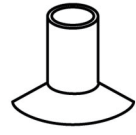

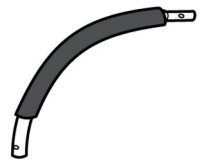
Description:
Mallet

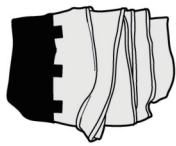
PARTS LIST

<p>Part A</p>  <p>Description: Top rail Part number: JK36IV-TR Quantity: 5</p>	<p>Part B</p>  <p>Description: Straight leg Part number: JK36IV-L Quantity: 3</p>	<p>Part C</p>  <p>Description: Straight leg with welded tube Part number: JK36IV-LA Quantity: 2</p>	<p>Part D</p>  <p>Description: Leg end cap Part number: JK36IV-LCAP Quantity: 5</p>	<p>Part E</p>  <p>Description: Straight handle pole left (A marking) Part number: JK36IV-SPL Quantity: 1</p>
<p>Part F</p>  <p>Description: Straight handle pole right (B marking) Part number: JK36IV-SPR Quantity: 1</p>	<p>Part G</p>  <p>Description: Curve handle pole left (A marking) Part number: JK36IV-CPL Quantity: 1</p>	<p>Part H</p>  <p>Description: Curve handle pole right (B marking) Part number: JK36IV-CPR Quantity: 1</p>	<p>Part I</p>  <p>Description: Elastic Rope with plastic ball Part number: JK36IV-BB Quantity: 25</p>	<p>Part J</p>  <p>Description: Jumping mat with frame cover Part number: JK36IV-BP Quantity: 1</p>
<p>Part K</p>  <p>Description: User Manual</p> <p>Quantity: 1</p>				

STEP 1 : ASSEMBLING THE FRAME

Lay out the Top rails and legs frame parts in groups:

- 1) Top rail part A: 5 pcs,
- 2) Straight Leg part B: 3 pcs,
- 3) Straight Leg with welded tube part C: 2 pcs,
- 4) Leg end cap part D: 5 pcs.

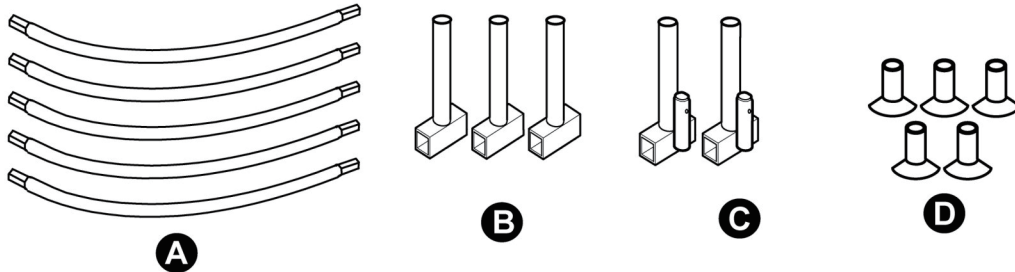

Insert the leg's end cap to the straight leg.

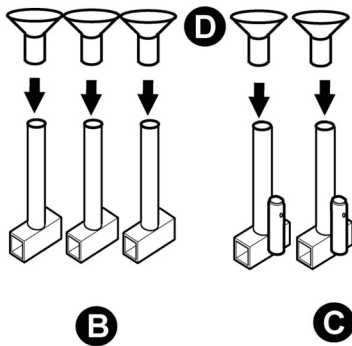

Insert the top rail into straight leg x 3 sets.

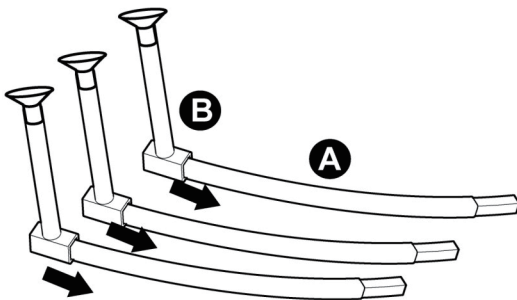

Insert the top rail into straight leg with welded tube x 2 sets.

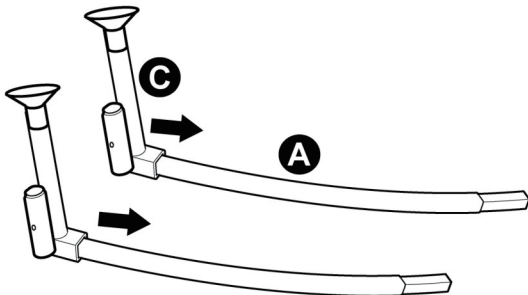

Insert the top rail.

a)

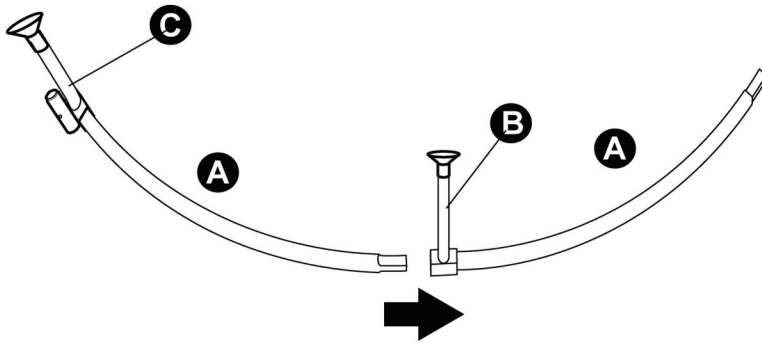

b)

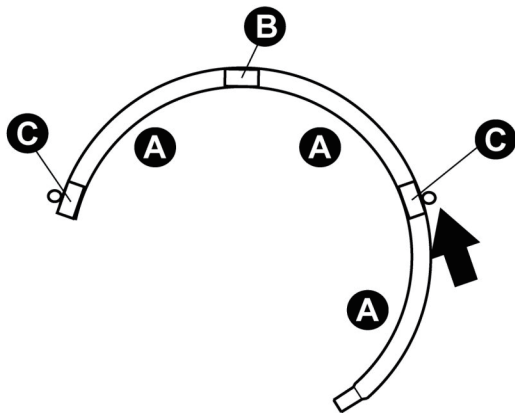

c)

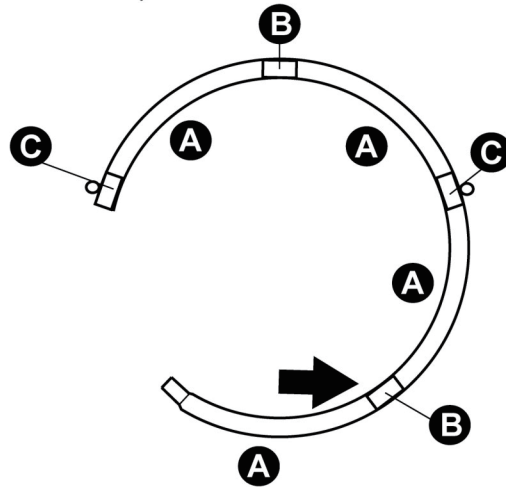

d)

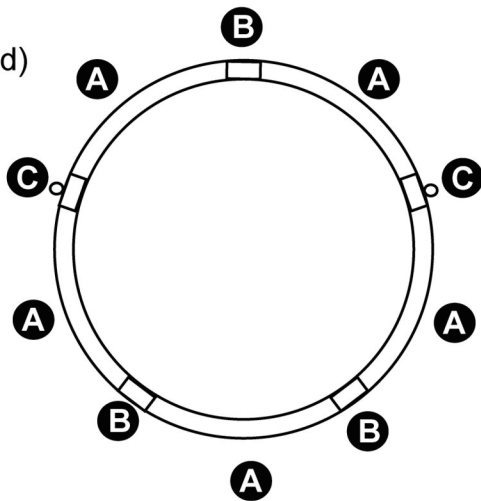

STEP 2: ASSEMBLING THE JUMPING MAT

Lay out the jumping mat with frame cover part I: 1 pc
and
Elastic rope with plastic ball part J: 25 pcs.



Lay out the jumping mat with frame cover into trampoline. Using the elastic rope attach the mat to the frame in location 1. Repeat this step to attach 4 remaining elastic rope in location 2-3-4-5 as shown. One elastic rope on centered in between each leg.

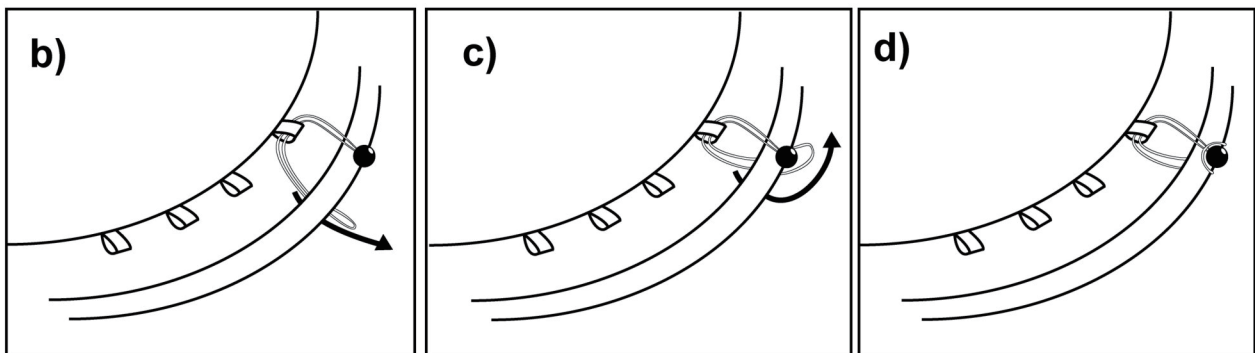
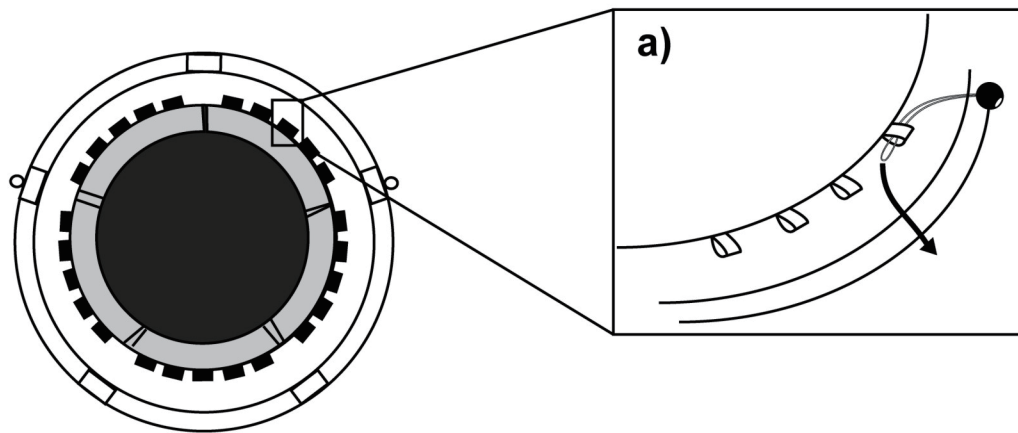
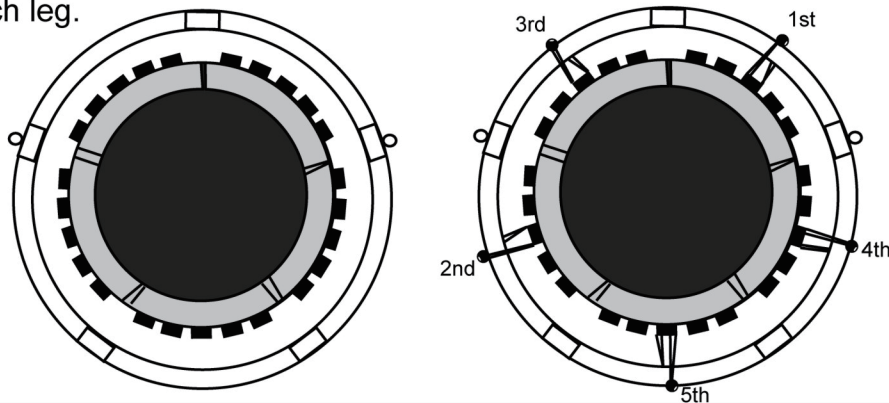

Follow the diagram below, continue to place the elastic ropes around the frame until all 25 ropes are used.

Important: Make sure the plastic balls on the elastic ropes are located on the underside of the trampoline!

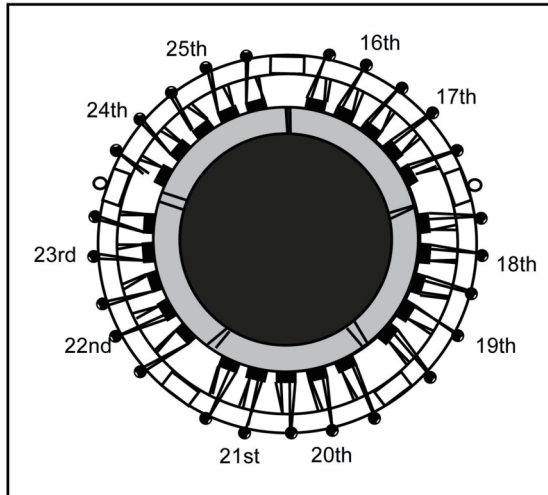
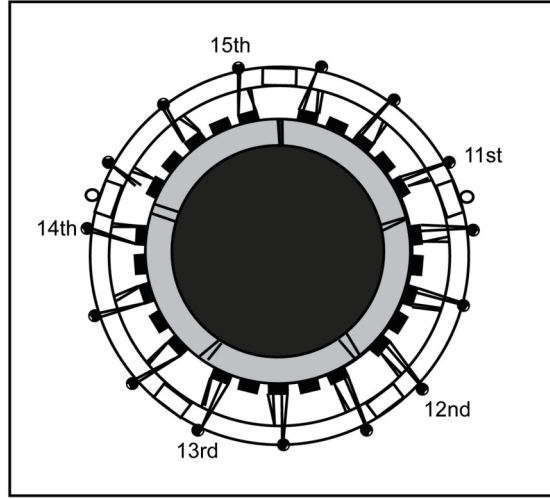
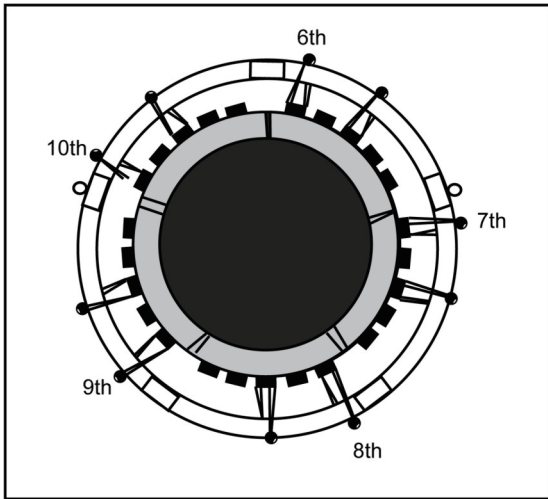

STEP 3: ASSEMBLING THE SAFETY PAD

Pull the elastic rope on surrounding of edge of safety pad over the straight legs.

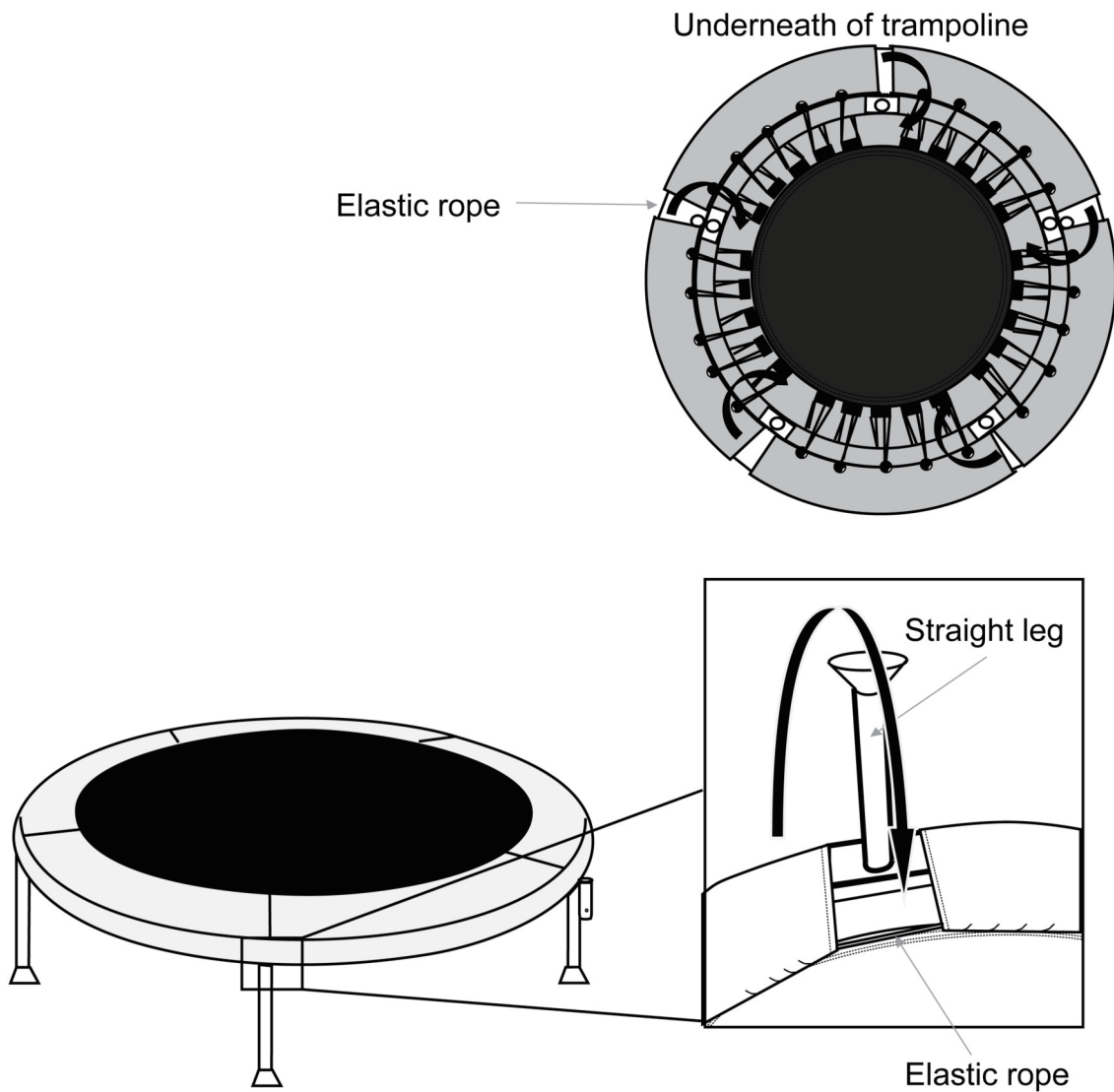

STEP 4: ASSEMBLING THE HANDLE BAR

Lay out the handle bar tubing in group:

- 1) Straight handle pole left part E (A marking): 1 pc,
- 2) Straight handle pole right part F (B marking): 1 pc,
- 3) Curve handle pole left part G (A marking): 1 pc,
- 4) Curve handle pole right part H (B marking): 1 pc,

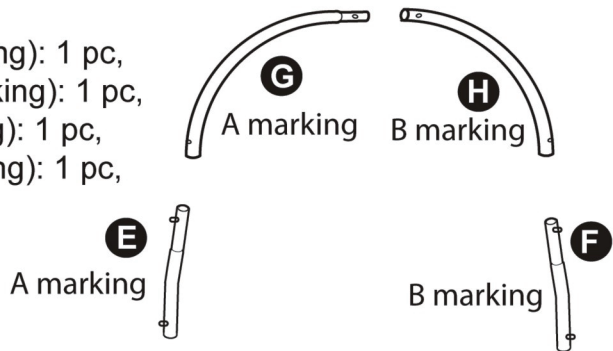

Insert the Straight handle pole left part E (A marking) and Straight handle pole right part F (B marking) into the slot of the Straight leg with welded tube part C (1). Push the pin inwards (2) and fully insert the tubing. Ensure the pin is protruding through the slot in the tubing.

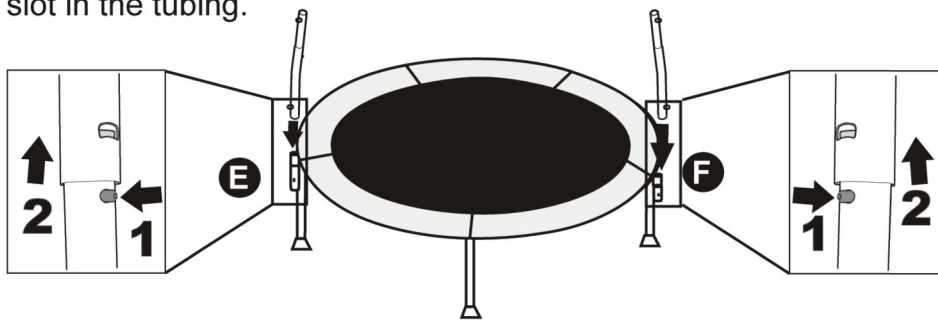

Connect the Curve handle pole left part G (A marking) and Curve handle pole right part H (B marking) (1). Push the pin inwards (2) and fully insert the tubing. Ensure the pin is protruding through the slot in the tubing.

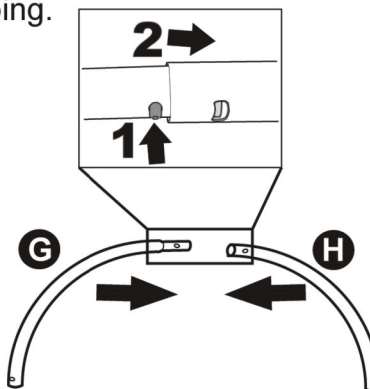

Then connect the Curve handle poles to the Straight handle poles.
The trampoline is completed!!

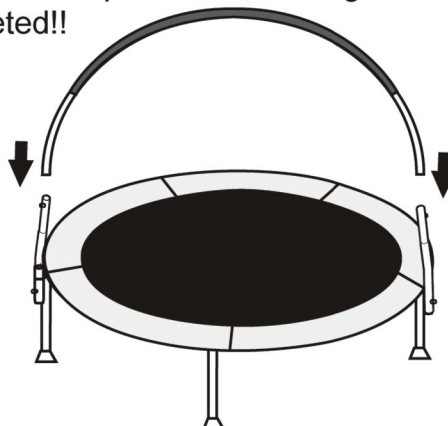

CARE AND MAINTENANCE

Care

Do not allow pets or animals on the trampoline as claws may snag and pull the bed material or damage the frame pad

The trampoline is intended to be used by one person at a time weighing 38 kg (85 lbs) or less.

The user should be either barefoot or wearing socks. Street shoes or tennis shoes should not be worn on the trampoline. The user should remove all sharp objects from his or her person that may cause injury or damage to the bed. Heavy, sharp, or pointed hard objects should not contact the bed.

Maintenance

Your trampoline is manufactured using quality materials and crafted to provide your children with many years of enjoyment. Proper maintenance and care will help to prolong the life of the trampoline and reduce the possibility of injury.

Prolonged exposure to the sun, will shorten the life of the trampoline fabric. For longer fabric life store the trampoline when it is not being used.

A dry trampoline, properly stored, will provide the longest life of the fabric, sewing, and hardware.

The following guidelines should always be observed. Inspect the trampoline before each use and replace any worn, damaged, or missing parts.

The following conditions could represent potential hazards and increase the chance of personal injury:

- a missing, improperly positioned, or insecurely attached frame pad, foam sleeves.

- punctures, frays, tears, or holes worn in the bed, frame pad, foam sleeves.

- deterioration in the stitching or fabric of the bed, frame pad.

- broken or missing elastic rope.

- a bent or broken frame, leg.

- a sagging bed.

- sharp protrusions on the frame, suspension system.

If any of these conditions exist, the trampoline should be disassembled or otherwise protected against use until the condition is corrected.

Removing and storing the trampoline

Make sure that the trampoline is dry before removing and storing it. Use caution while removing the tubes due to the weight of the tubes.

To disassemble the trampoline, follow the assembly steps in reverse order (see pages 6 to 11). Do not attempt to disassemble the frame sections, legs or bases before the bed and elastic ropes have been removed.