

# ASSEMBLY INSTRUCTION

Thank you for purchasing the quality product. Be sure to check all packing material carefully for small parts which may have come loose inside the carton during shipment. Separate, identify and count all parts and metal hardware. Compare with all parts list to be sure all parts are present. If any part(s) are missing or damaged, please contact your local furniture dealer. For efficient and speedy service, please indicate the model number and code letter of part(s) needed.

**\*\*\*Do not fully tighten screws until fully assembled\*\*\***

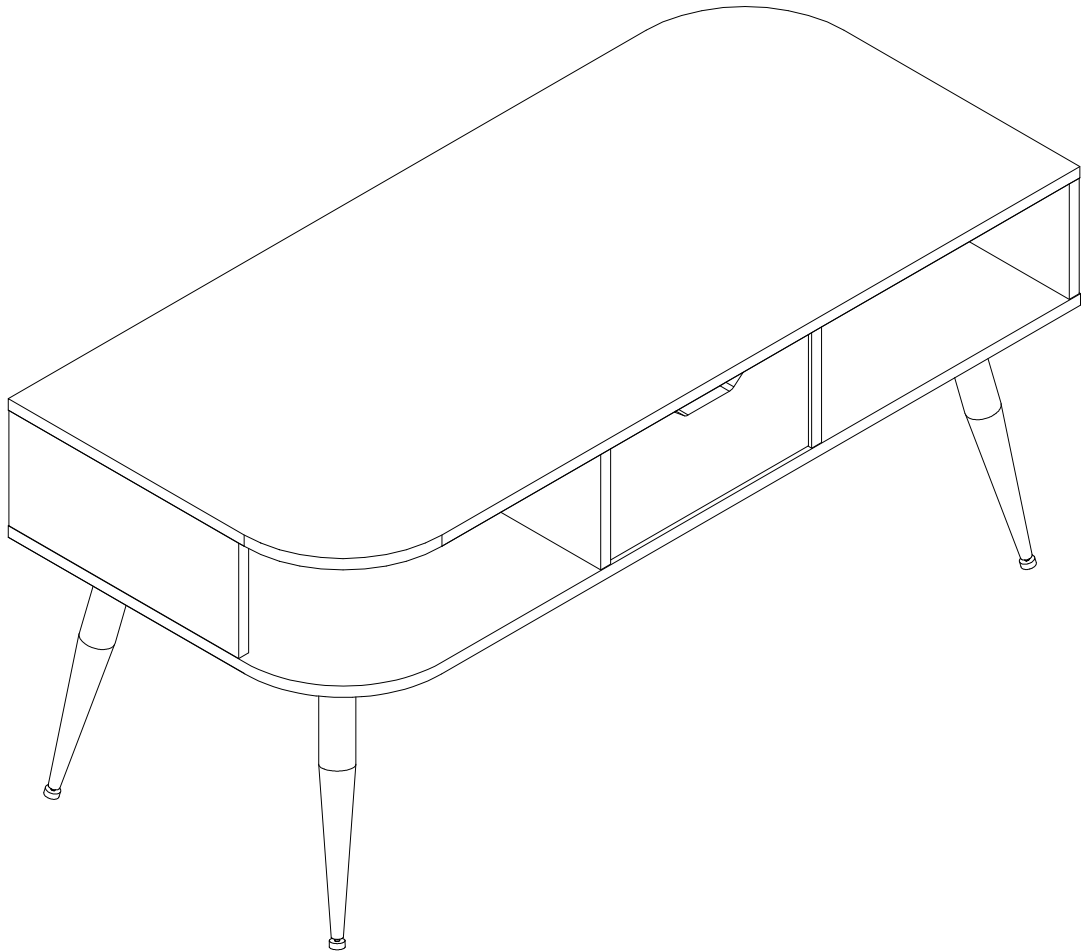

## Attention:

\*\*\*Some number parts listed on the instruction sheet may not be in parts bag as they may already be assembled. Carefully check parts and packing materials prior to ordering replacements.

# General Assembly Guidelines

- I. Ensure that all parts and hardware are available before beginning assembly.
- II. Follow each step carefully to ensure the proper assembly of this product.
- III. Two people are recommended for ease in the assembly of this product.
- IV. The three main types of hardware used to assemble this product are: wood dowels, screws and bolts.
- V. A Phillips head screwdriver is required for the assembly of this product.

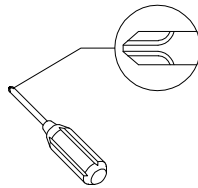

- VI. Power tools should not be used to assemble this product.

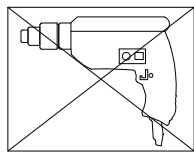

# COMPONENT PARTS

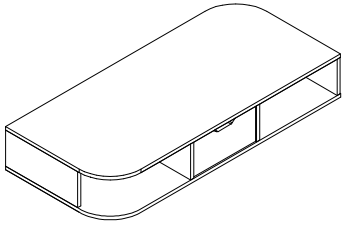
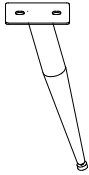

DESCRIPTION	PART NAME	QTY(PCS)
①	 Body	1
②	 Metal Legs	4

## Hardware List

A		M6x15mm	Bolt	8 pcs
B		M6mm	Washer	8 pcs
C		M4mm	Allen Key	1 pcs

*The hardware quantities listed above are required for proper assembly.  
Some extra hardware may also have been included.*

# Step 1

A x 8	B x 8	C x 1
 M6x15mm	 M6mm	 M4mm

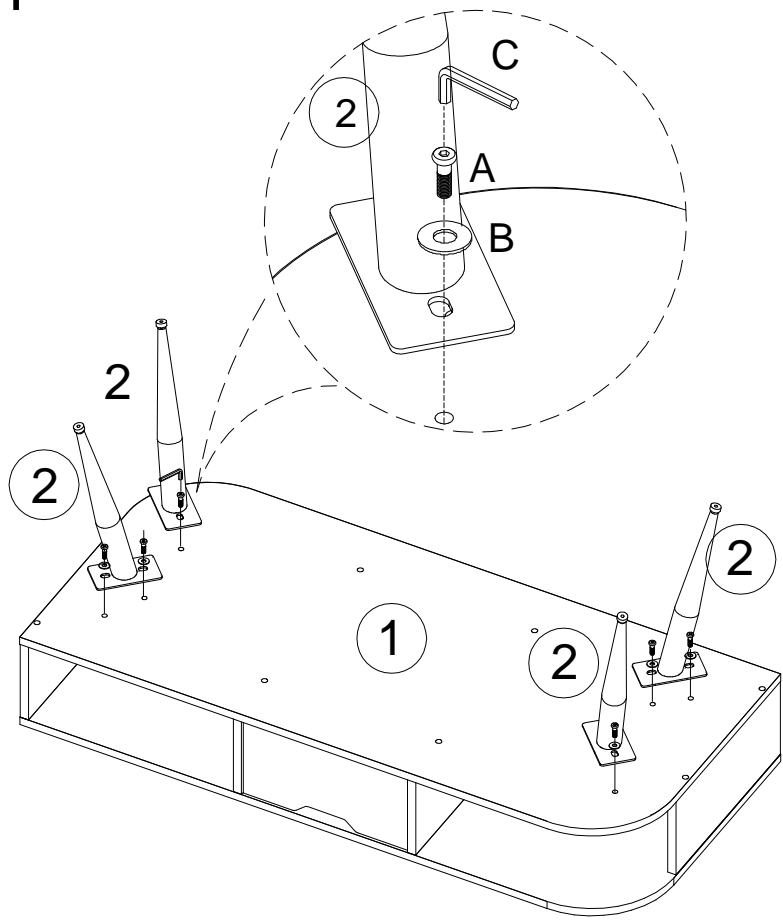

# Step 2

