

RDY05B

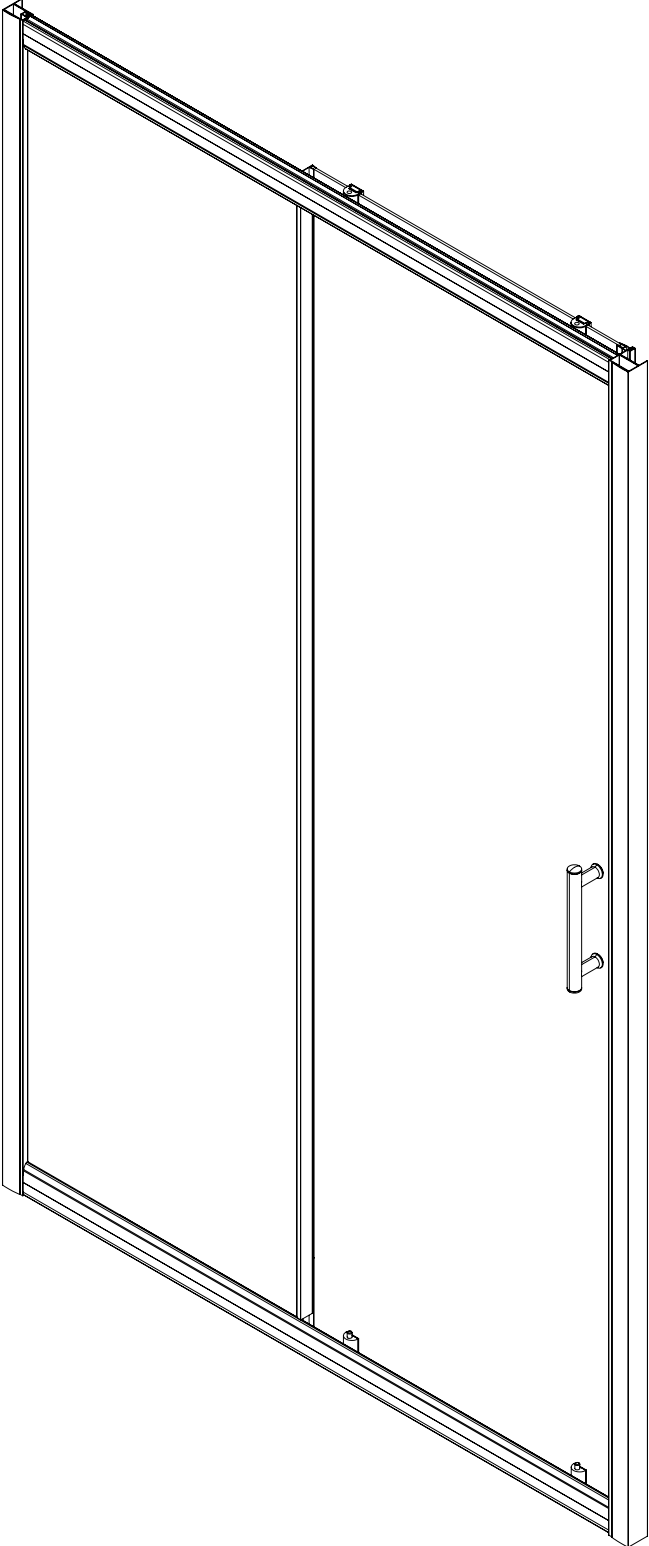

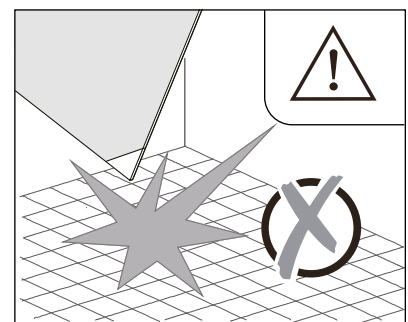

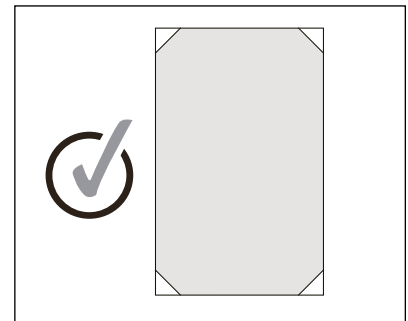

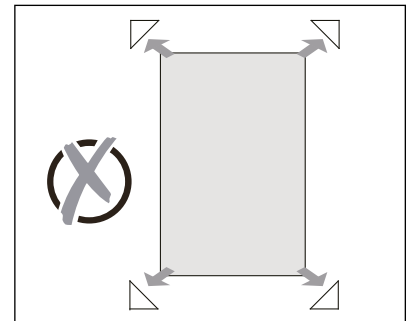
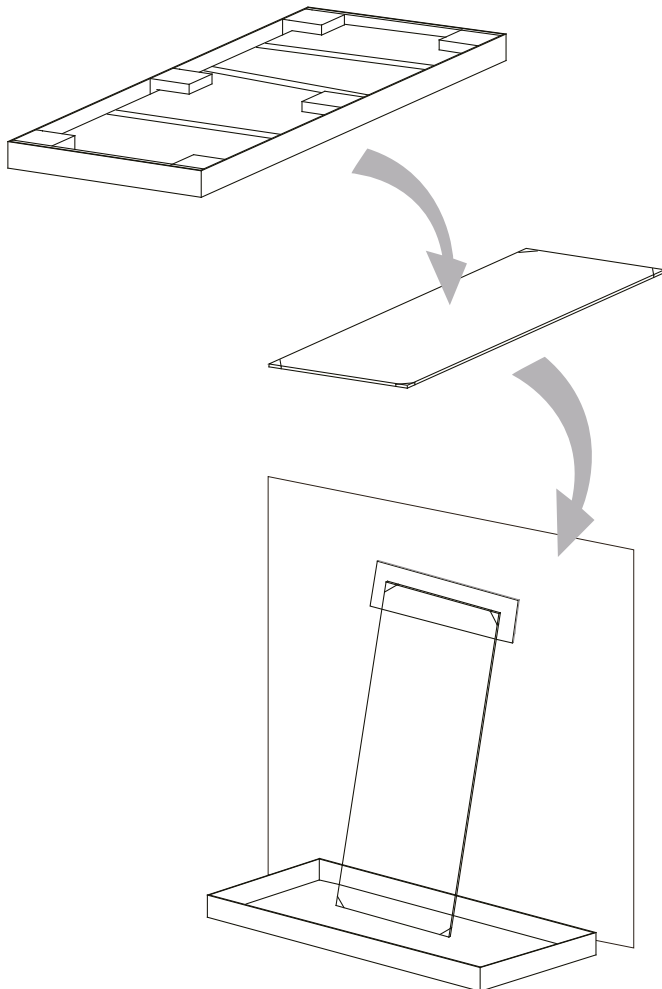
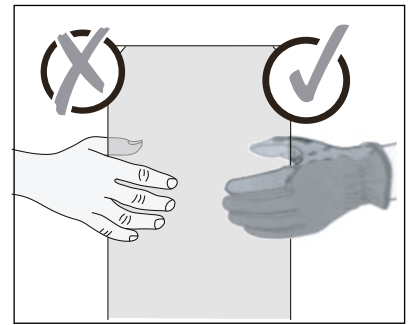
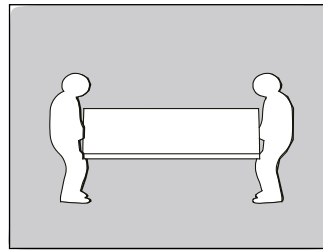
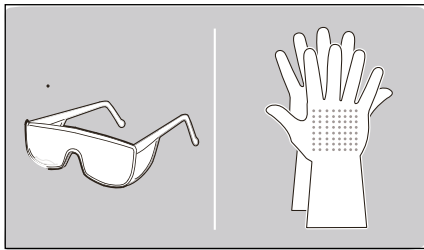
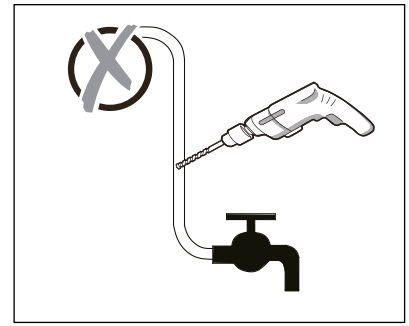
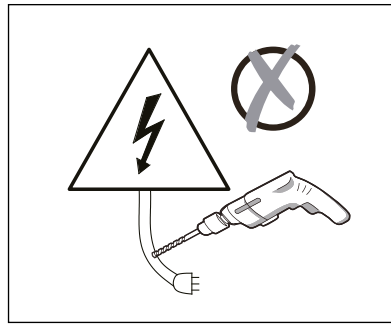
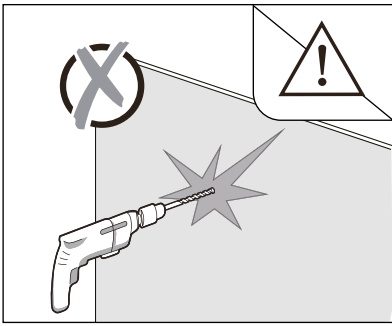
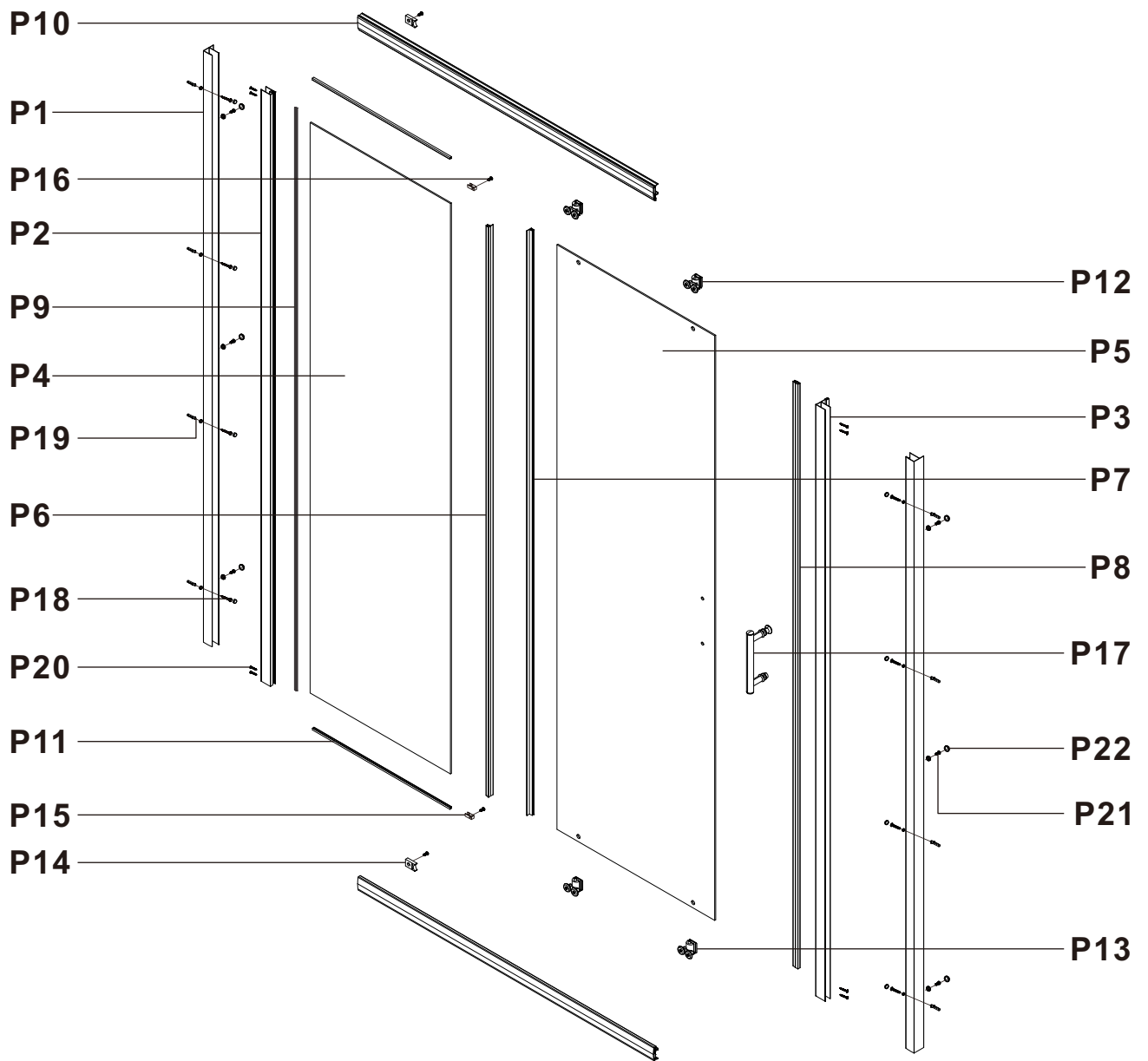
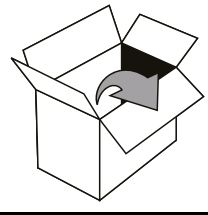

P1 X2	P2 X1	P3 X1	P4 X1
P5 X1	P6 X1	P7 X1	P8 X1
P9 X1	P10 X2	P11 X2	P12 X2
P13 X2	P14 X2	P15 X1	P16 ST4x11MM X2
P17 X1	P18 ST3.5x30MM X8	P19 X8	P20 ST3.9x20MM X8
P21 ST4x10MM X8	P22 X14		

 Ø 6mm	
 ⊕ PH2	
 Ø 3mm	

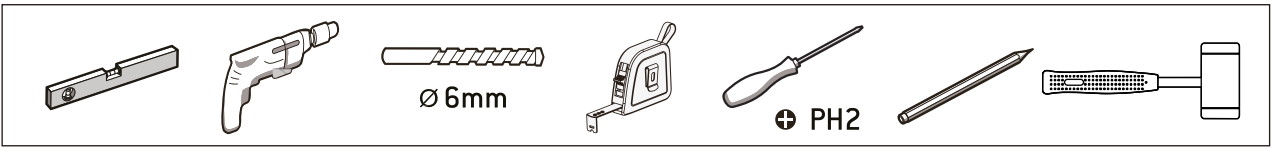

1

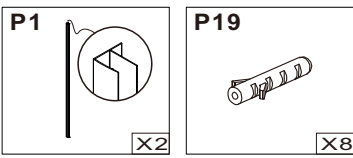
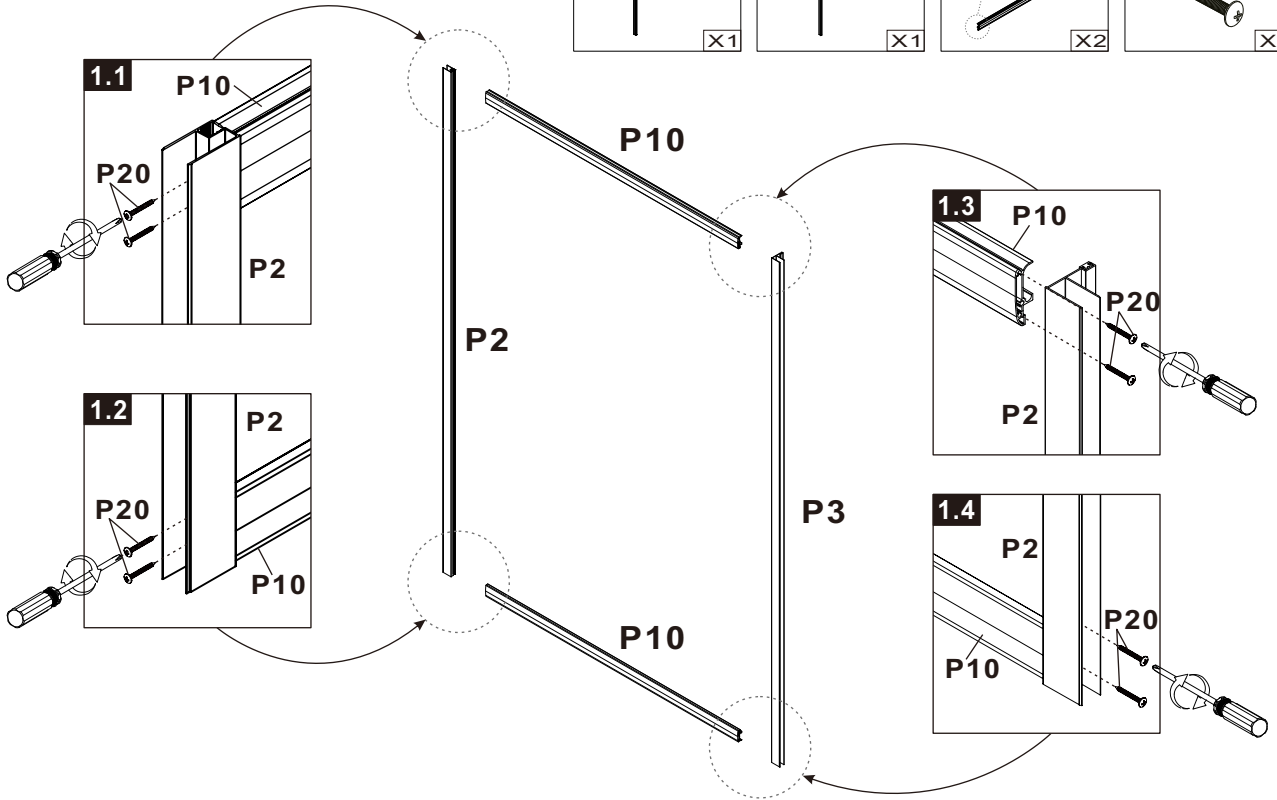
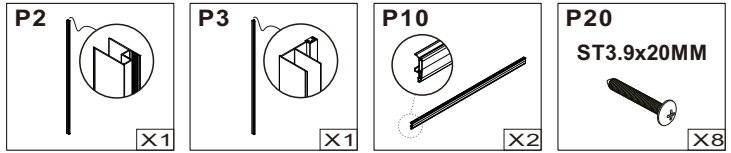

2

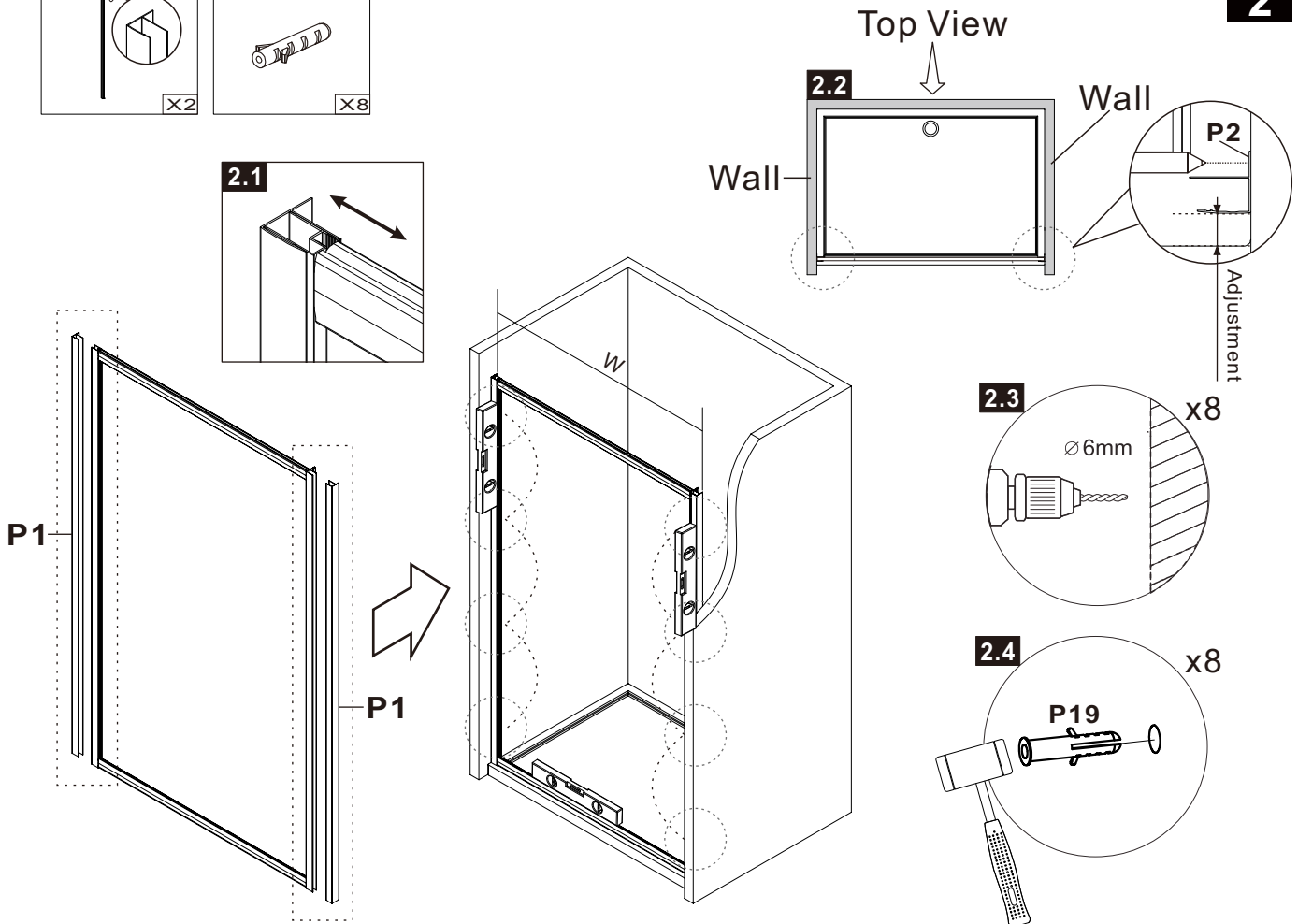

6



⊕ PH2

3



X8

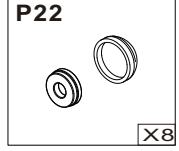

X8

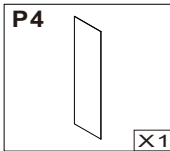
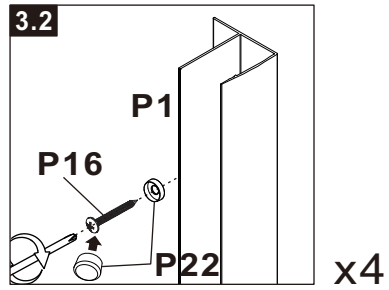
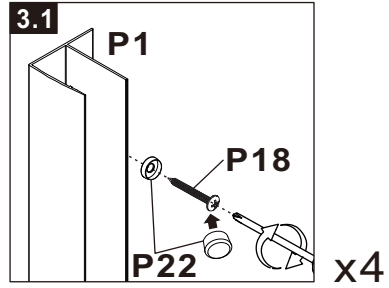
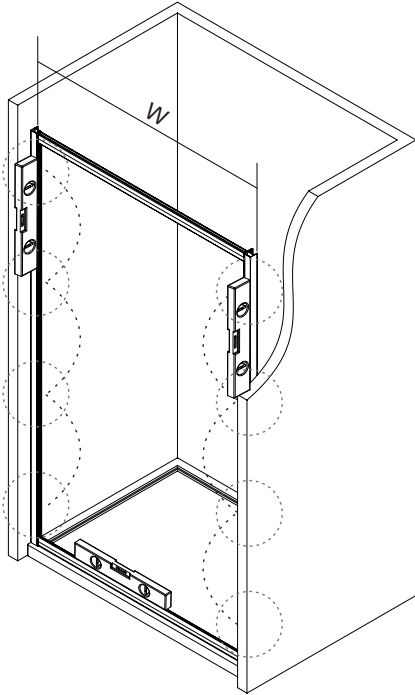

X1

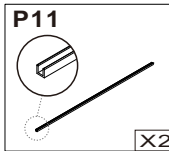

X2

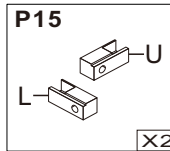

X2



X2

4

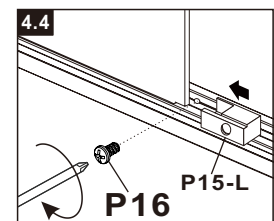
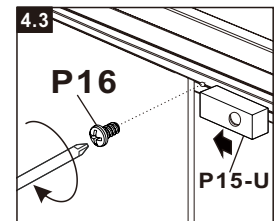
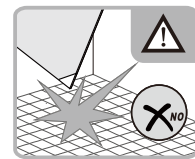
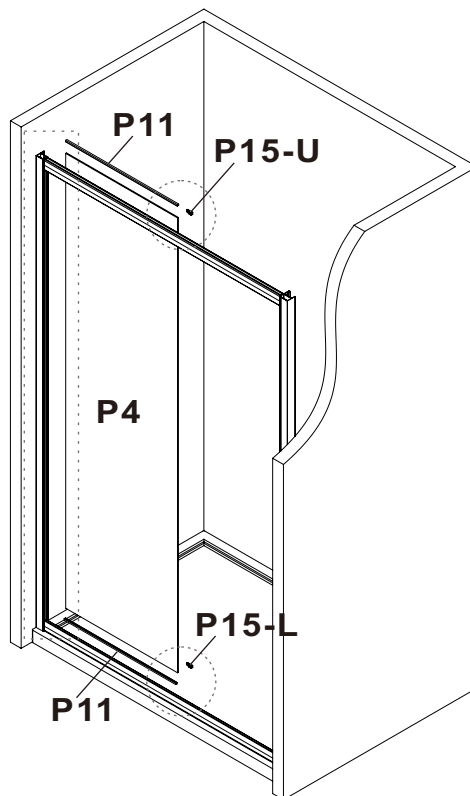
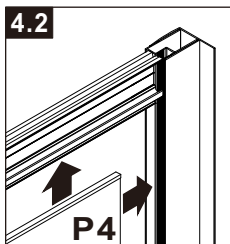
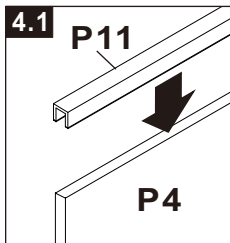



PH2

5

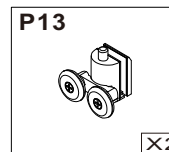
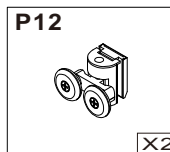
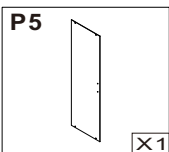
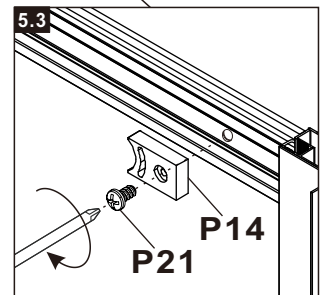
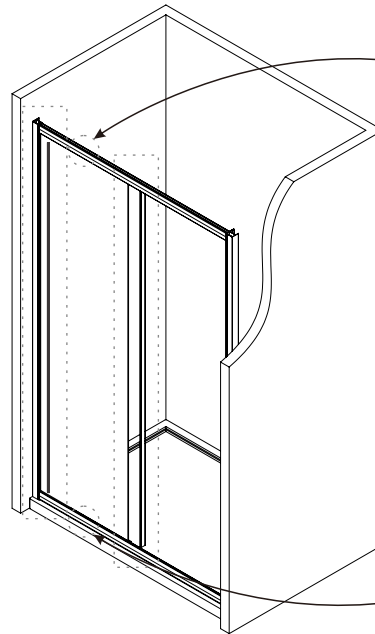
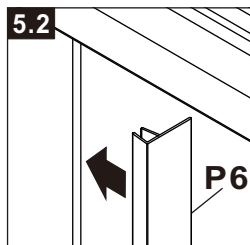
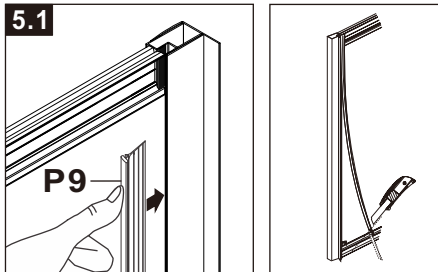
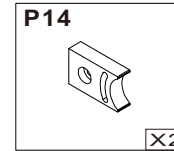
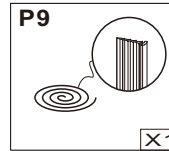
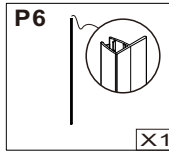

6

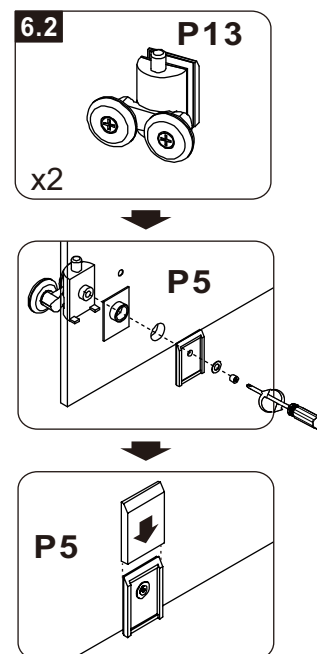
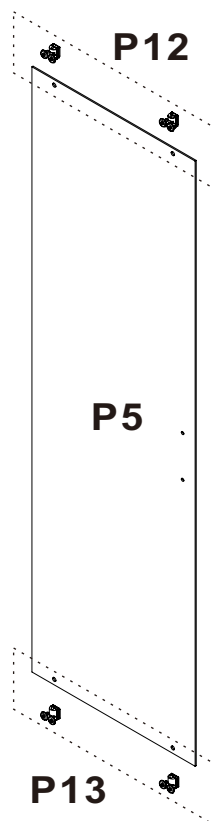
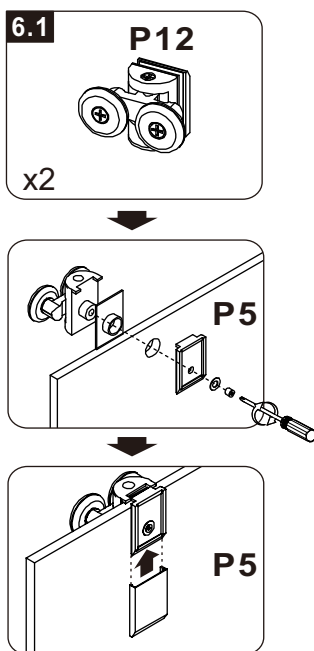
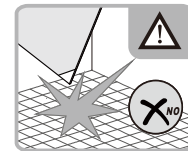



7

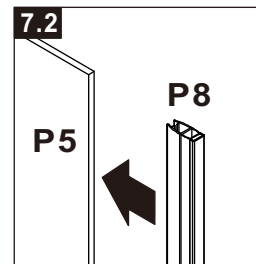
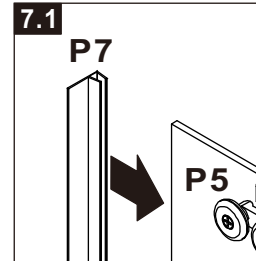
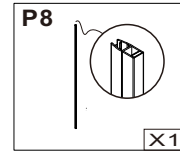
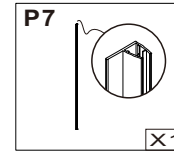
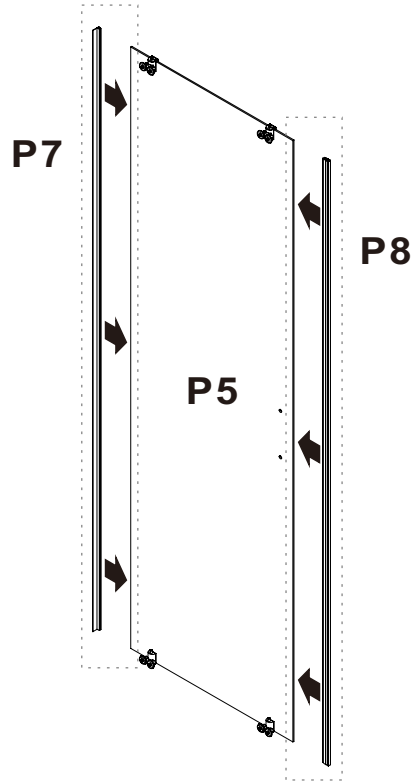
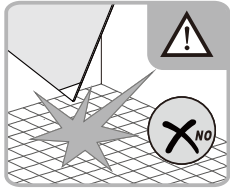

8

Bottom

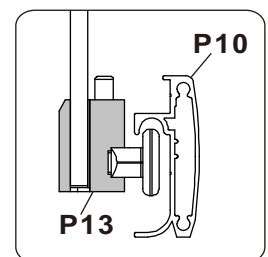
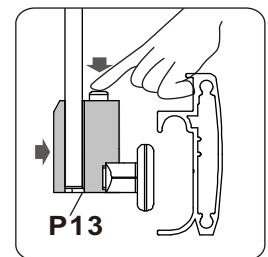
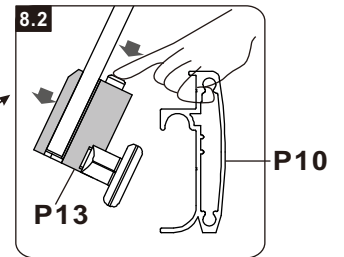
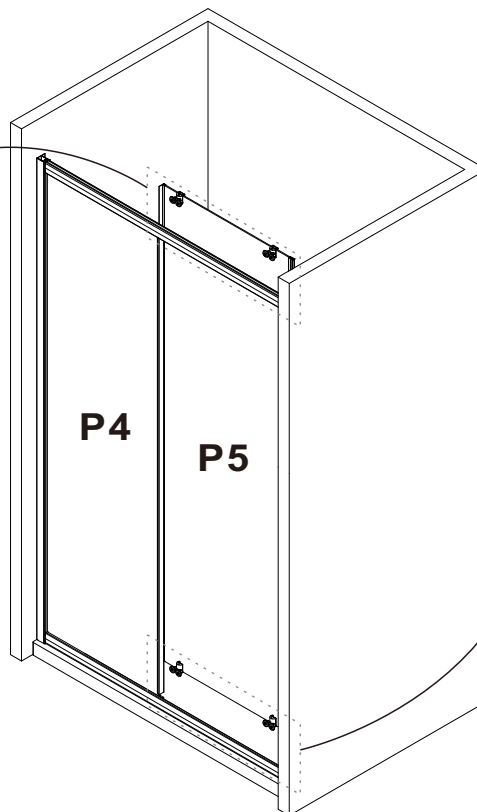
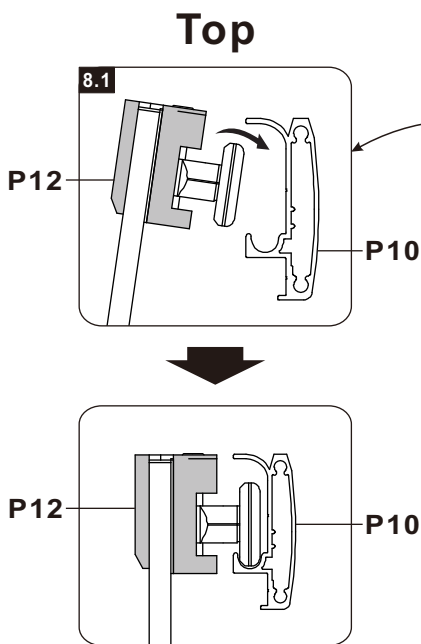



Ø3mm



PH2

9

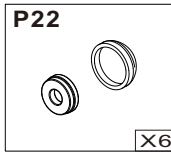
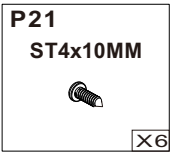
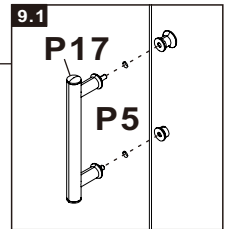
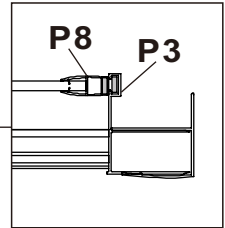
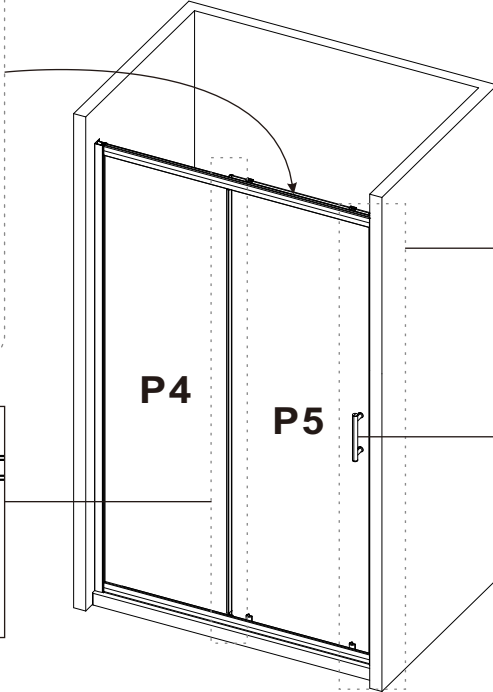
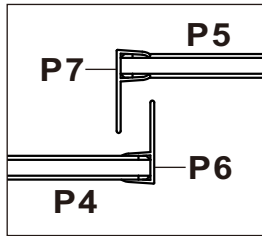
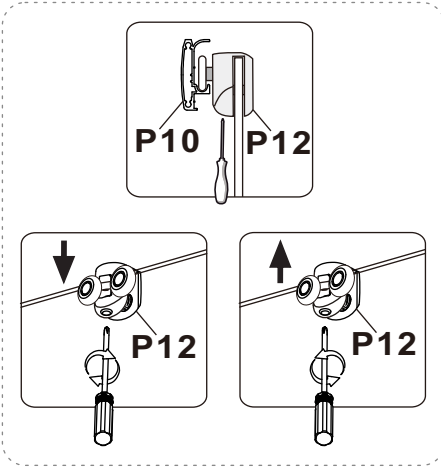
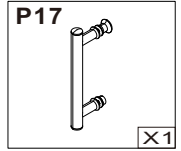

10

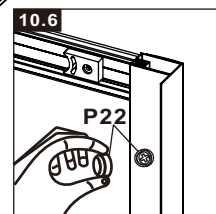
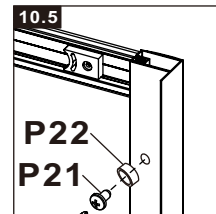
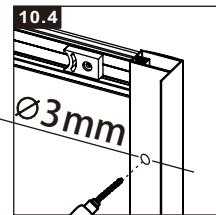
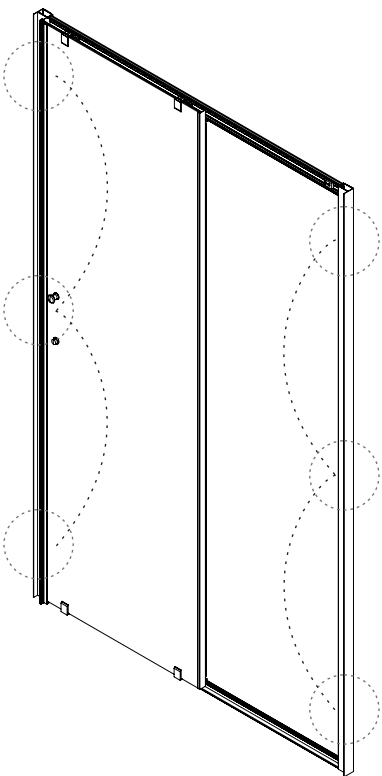
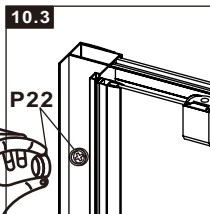
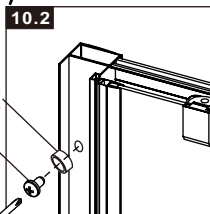
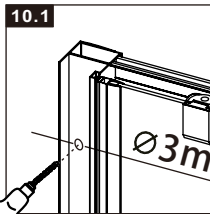



11

