

# MANUAL INSTRUCTION

## TV STAND

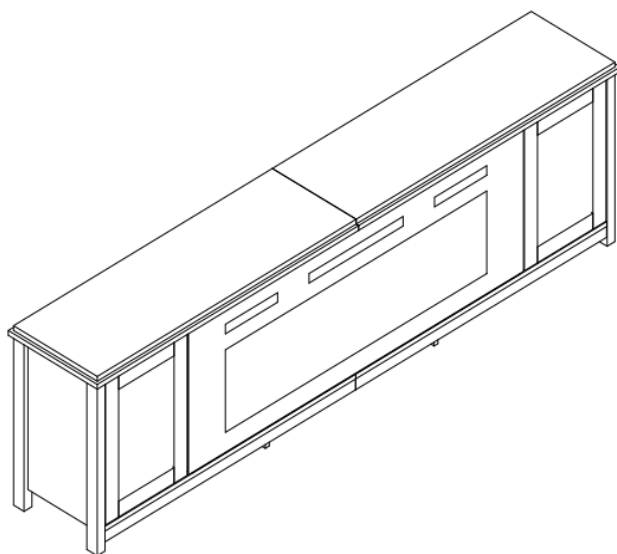

## **Indoor Furniture**

---

We are a professional furniture provider with top-notch factories and outstanding designs, Our mission is to provide consumers with new lifestyles. By collecting consumer feedback, we constantly improve our products and create more choices for consumers. If you want to create your space, We are an ideal choice.

---

Always.

---



## WARNING

All the TV Stands have passed strict quality inspections before delivery . Read this manual carefully to ensure proper usage

---

Ensure that all parts and hardware are available before beginning assembly

## NOTICE

1. Children are not allowed to operate.
2. Faster installation is possible with power tools.
3. Do not pull the door vigorously to prevent the storage cabinet from tipping over.
4. Please attach the storage cabinet to the wall with an anti-tip device after installation is complete.
5. When using the storage cabinet for the first time, please keep it in a ventilated environment to allow the smell to fully evaporate.
6. When placing the partitions, please make sure the nails are firmly installed to prevent the partitions from falling off.
7. If any parts are missing, broken, damaged or worn, discontinue use of the product until repairs are made and/or factory replacement parts are installed.
8. Do not use this product in a manner inconsistent with the manufacturer's instructions, as this may void the product warranty.
9. If accessories are missing, please contact customer service for communication in time, we provide 7x24 hours customer care.
10. Do not use any attachments or accessories other than the original factory attachments and accessories.
11. Do not alter this equipment. Any alteration will create a safety hazard.

## WARNING

The product must be assembled by adult before use. Serious or fatal injury may occur from unexpected assembly or use.

1. During the assembly process, keep all parts away from babies or children.
2. Always securely fix this product to the wall. Make sure the wall area to be drilled is free from hidden electrical wires, water and gas pipes.
3. Use of tip-over restraints may only reduce, but not eliminate the risk of tip-over.
4. Unless specially designed to accommodate, do not set heavy objects on top of this product.
5. Place the heaviest items on the lowest shelf.
6. Never allow children to climb or bang on drawers, doors or shelves.

# TOOLS REQUIRED



PHILLIPS  
SCREWDRIVER



2Persons Assembly



Minimum 60 Minutes For Assembly

## HARDWARE

1

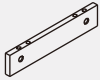

3 PCS

2

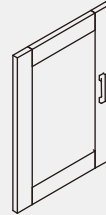

2 PCS

3

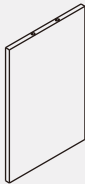

1 PC

4

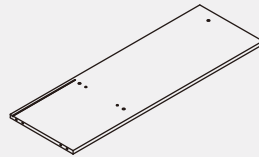

1 PC

5

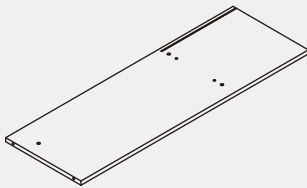

1 PC

6

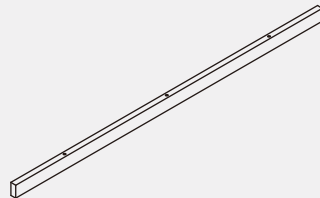

1 PC

7

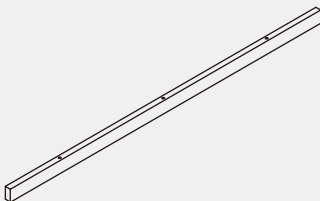

1 PC

8



1 PC

# HARDWARE

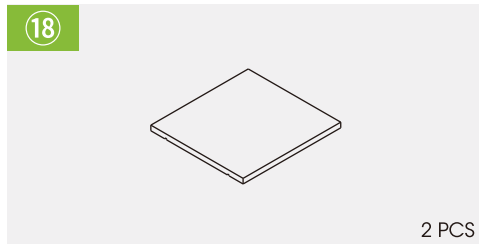
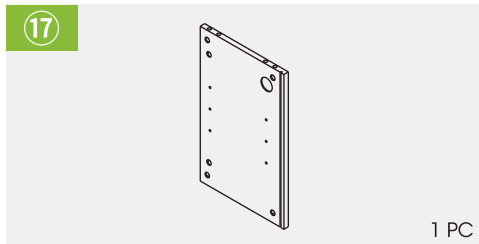
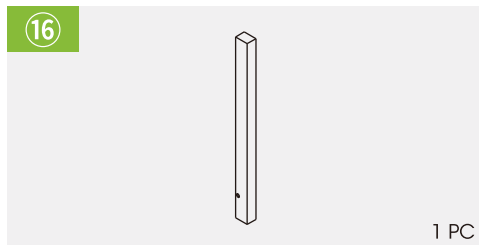
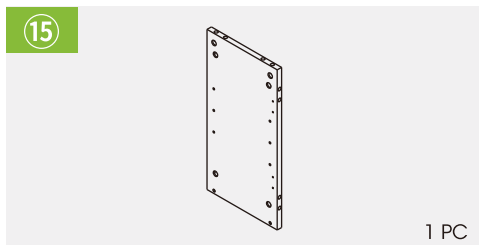
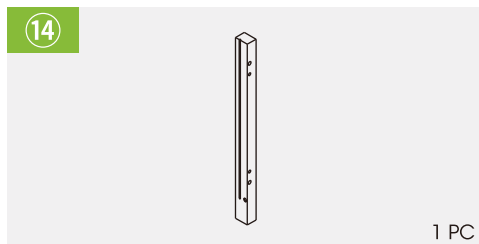
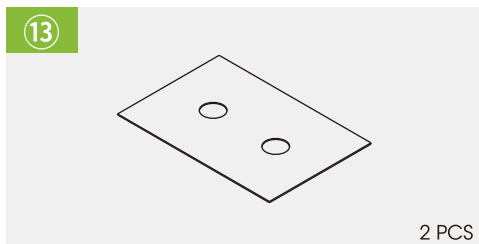
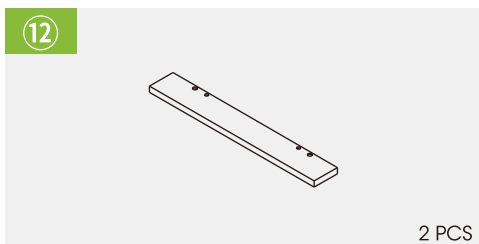
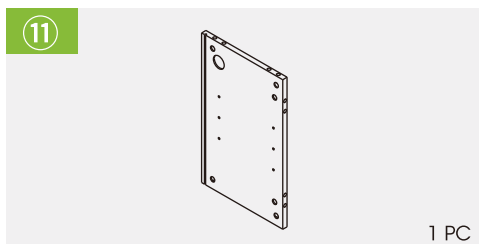
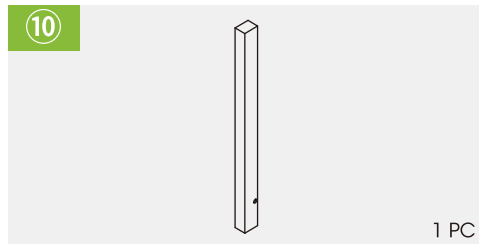
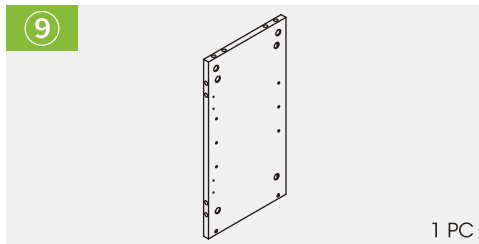

# HARDWARE

19

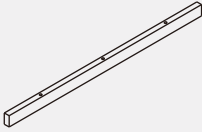

1 PC

20

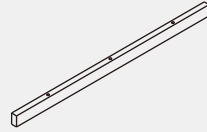

1 PC

21

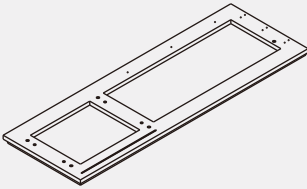

1 PC

22

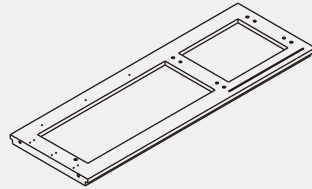

1 PC

23

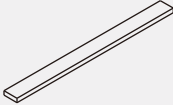

1 PC

# PARTS

**A** Ø5x31mm

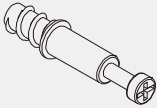

38 PCS

**B** Ø15x11mm



38 PCS

**C** Ø8x30mm



38 PCS

**D** Ø3.5x14mm



56 PCS

**E**

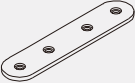

8 PCS

**F** Ø4x50mm



12 PCS

**G**

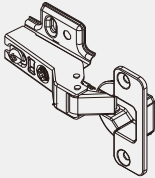

4 PCS

**H**

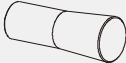

8 PCS

**J**

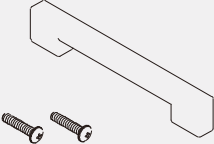

2 PCS

**K**

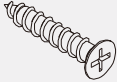

2 PCS

# BOARD IDENTIFICATION

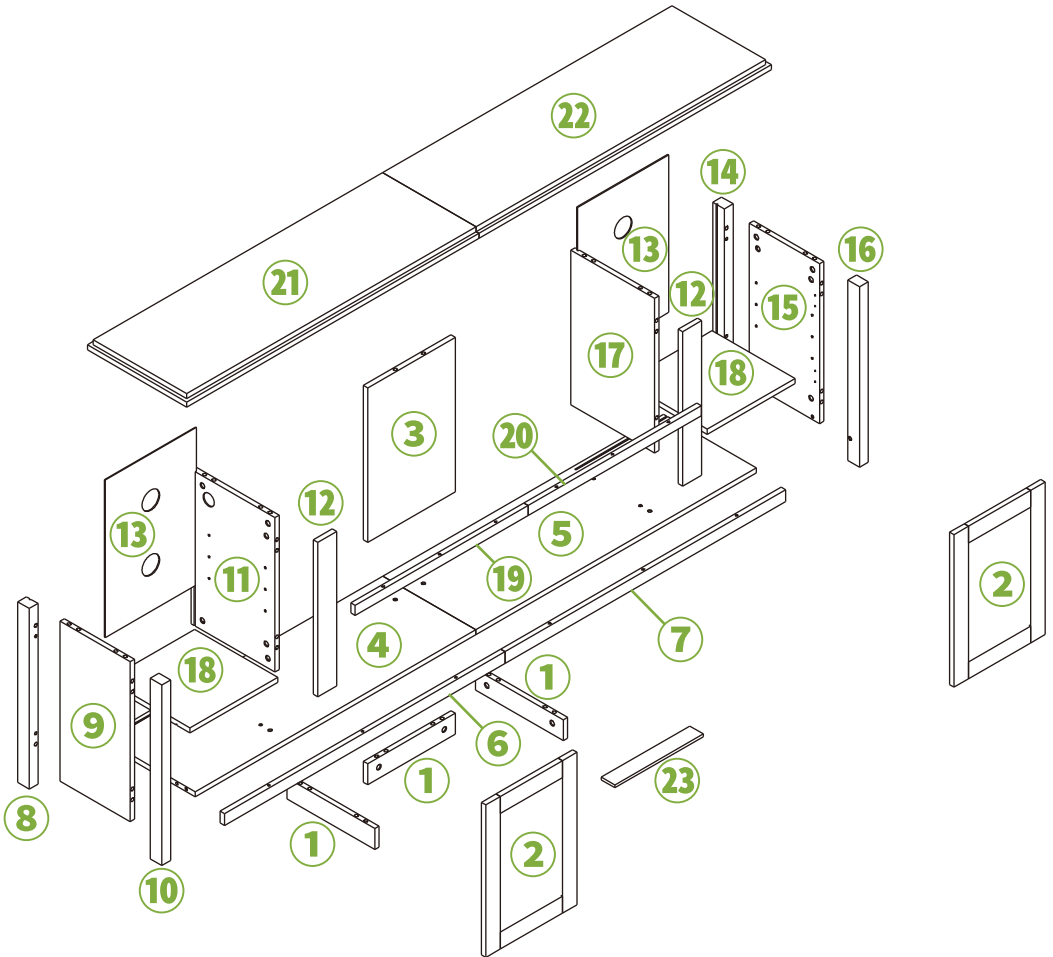

# PRODUCT ASSEMBLY

1

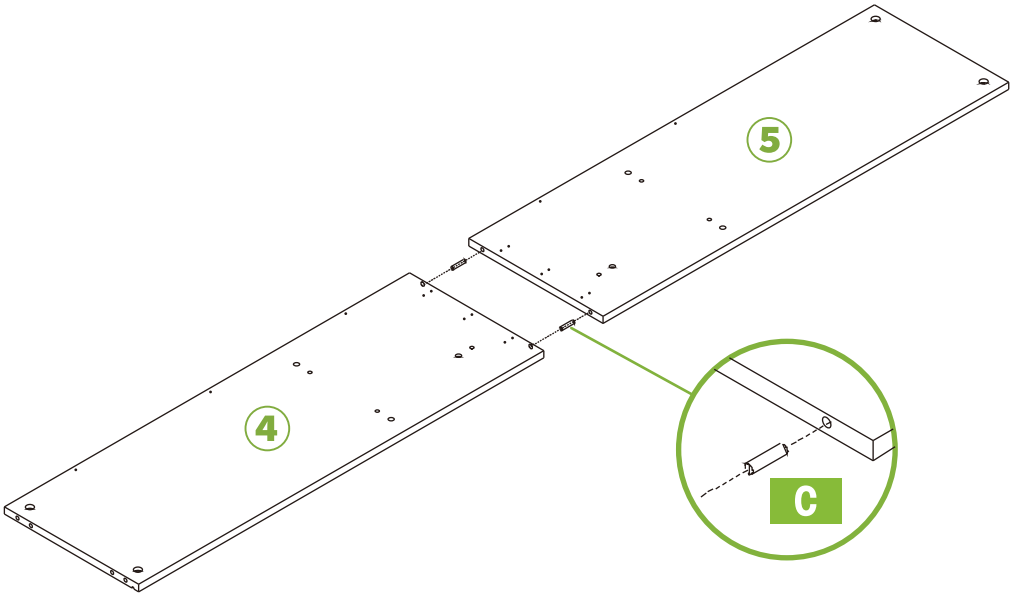

Insert wood dowel (C) into parts (4,5) Attach parts (4) and (5).

PART	NO.	QTY.
	<b>C</b>	2



# PRODUCT ASSEMBLY

## 2

PART	NO.	QTY.
	<b>D</b>	16
	<b>E</b>	4
	<b>F</b>	6

2. Attach pieces (E) to secure the connection in parts (6) and part (7) using screw (D) and a Phillips head screwdriver.

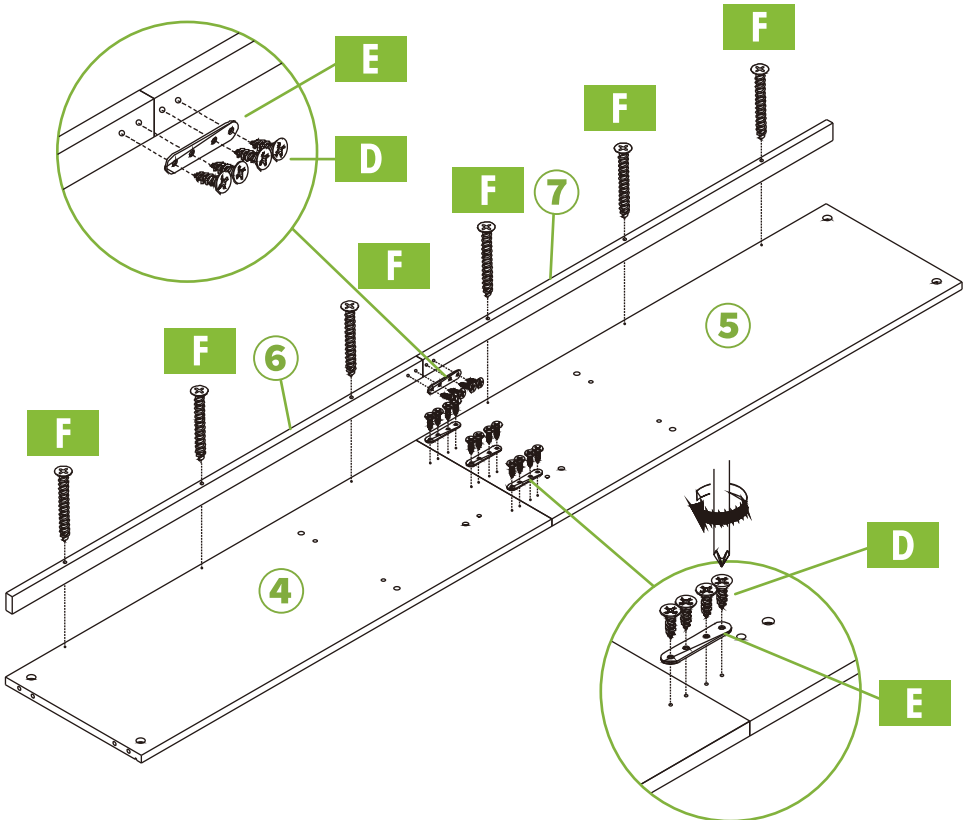

3. Attach parts (6,7) to parts (4,5) using screw F and a Phillips head screwdriver.



1. Attach pieces (E) to secure the connection in part (4) and part (5) using screw (D) and a Phillips head screwdriver.

# PRODUCT ASSEMBLY

## 3

PART	NO.	QTY.
	<b>A</b>	6
	<b>B</b>	6
	<b>C</b>	6

1. Insert cam bolt (A) into parts (4, 5)

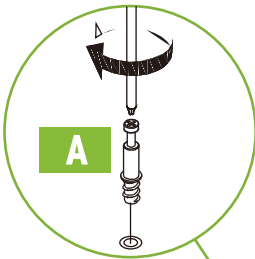

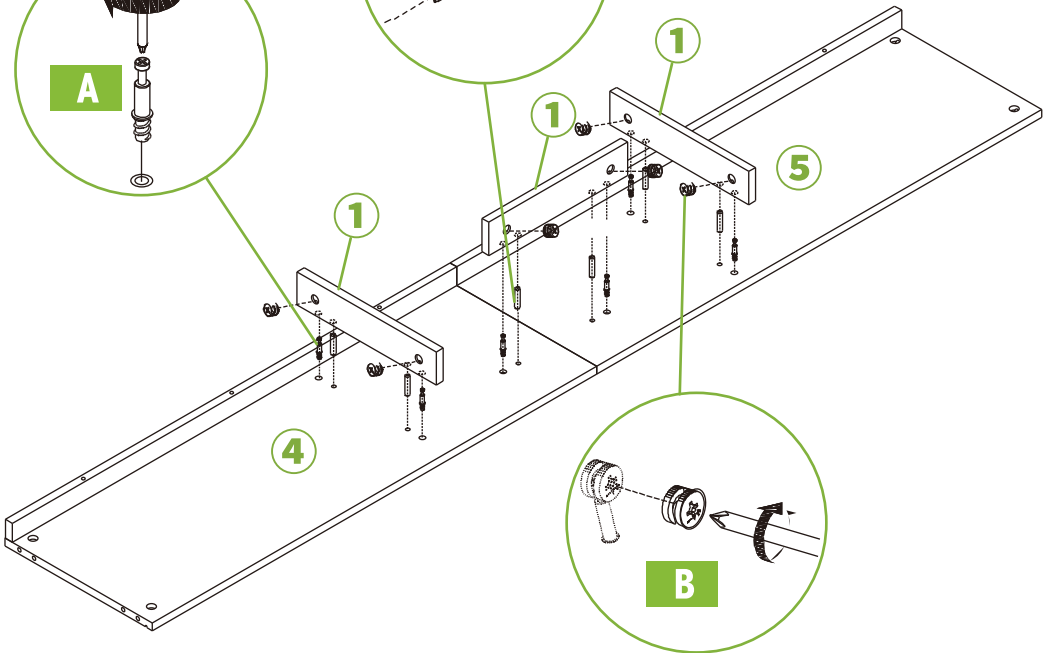
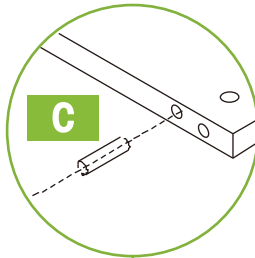

2. Insert wood dowel (C) into parts (1).



3. Attach part (1) to the wood dowels of parts (4) and (5) using cam lock (B) and Phillips head screwdriver.

# PRODUCT ASSEMBLY

## 4

PART	NO.	QTY.
	<b>A</b>	8
	<b>B</b>	8
	<b>C</b>	8

1. Insert cam bolt (A) into parts (8, 10, 14, 16)

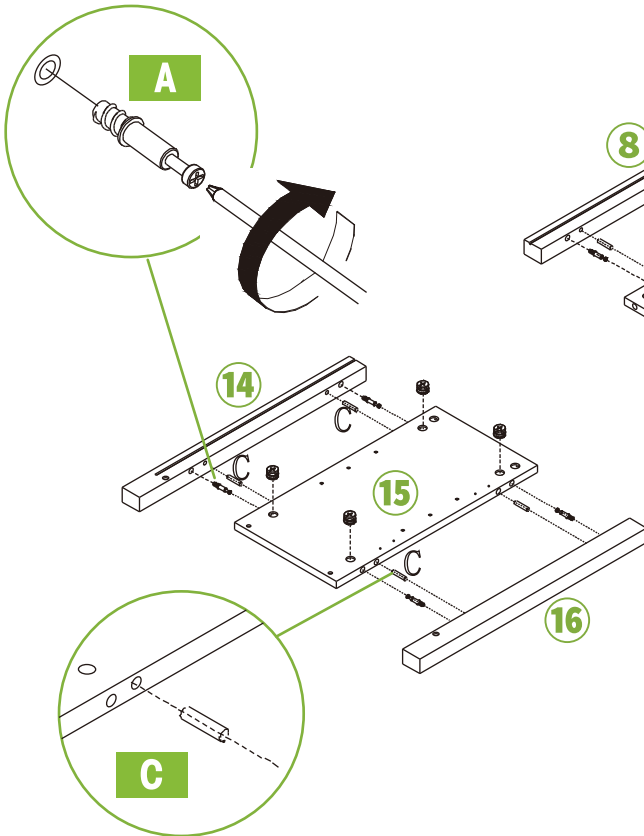

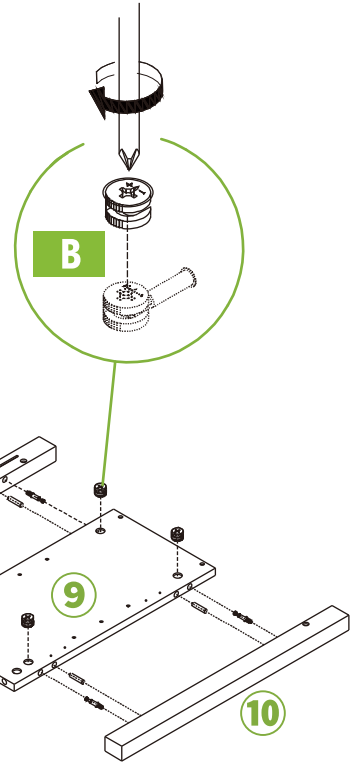

2. Insert wood dowel (C) into parts (9, 15).



3. Attach part (8, 10) to parts (9), attach part (14, 16) to parts (15) using cam lock (B) and Phillips head screwdriver.

# PRODUCT ASSEMBLY

## 5

PART	NO.	QTY.
	<b>A</b>	4
	<b>B</b>	4
	<b>C</b>	4

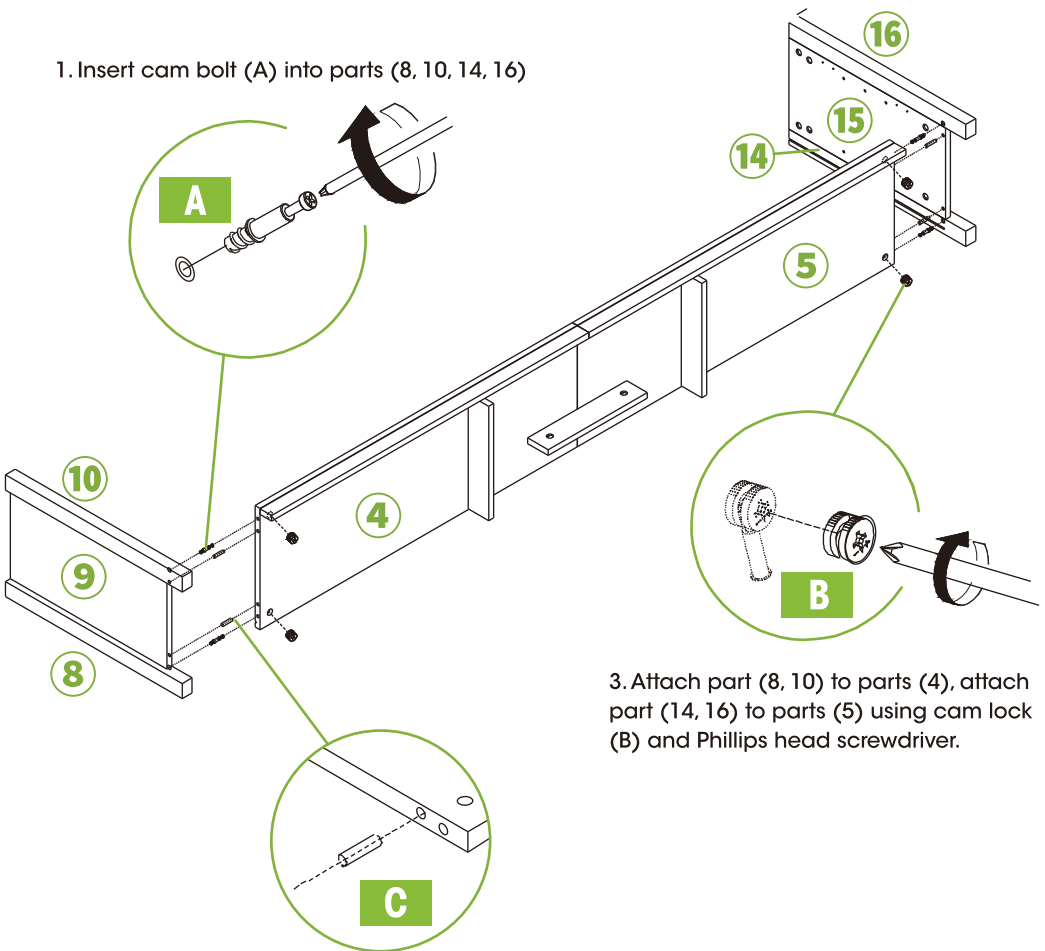

1. Insert cam bolt (A) into parts (8, 10, 14, 16)



2. Insert wood dowel (C) into parts (4, 5).

# PRODUCT ASSEMBLY

## 6

PART	NO.	QTY.
	<b>A</b>	4
	<b>B</b>	4
	<b>C</b>	4

1. Insert cam bolt (A) into parts (12).

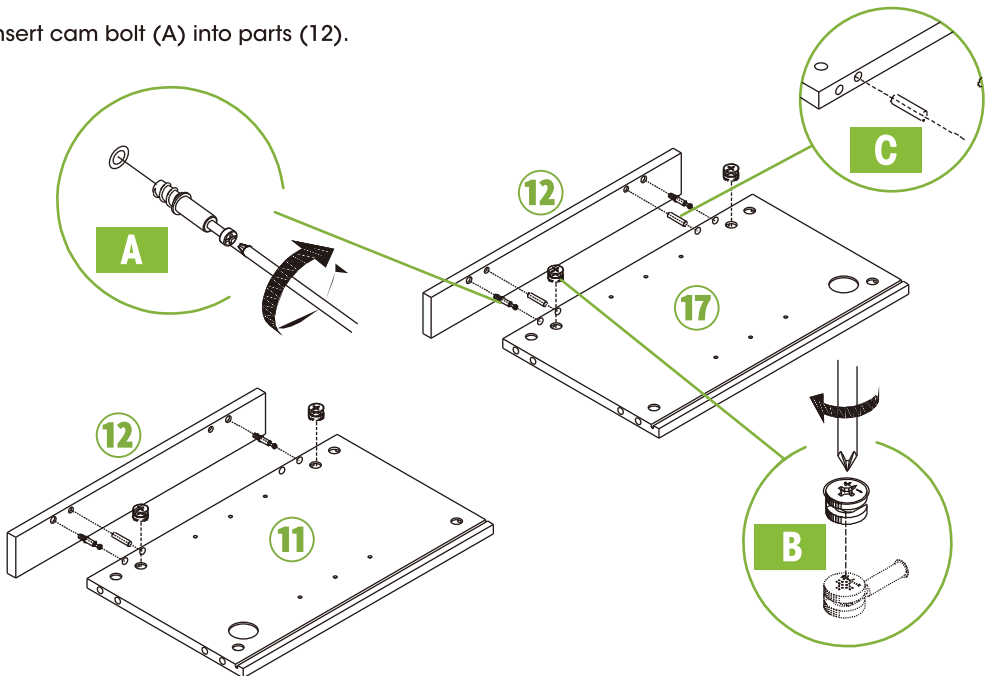

2. Insert wood dowel (C) into parts (11, 17).



3. Attach parts (12) to parts (11, 17) using cam lock (B) and Phillips.

# PRODUCT ASSEMBLY

## 7

PART	NO.	QTY.
	<b>A</b>	4
	<b>B</b>	4
	<b>C</b>	4

1. Insert cam bolt (A) into parts (4, 5)

3. Attach part (11) to parts (4), attach part (17) to parts (5) using cam lock (B) and Phillips head screwdriver.

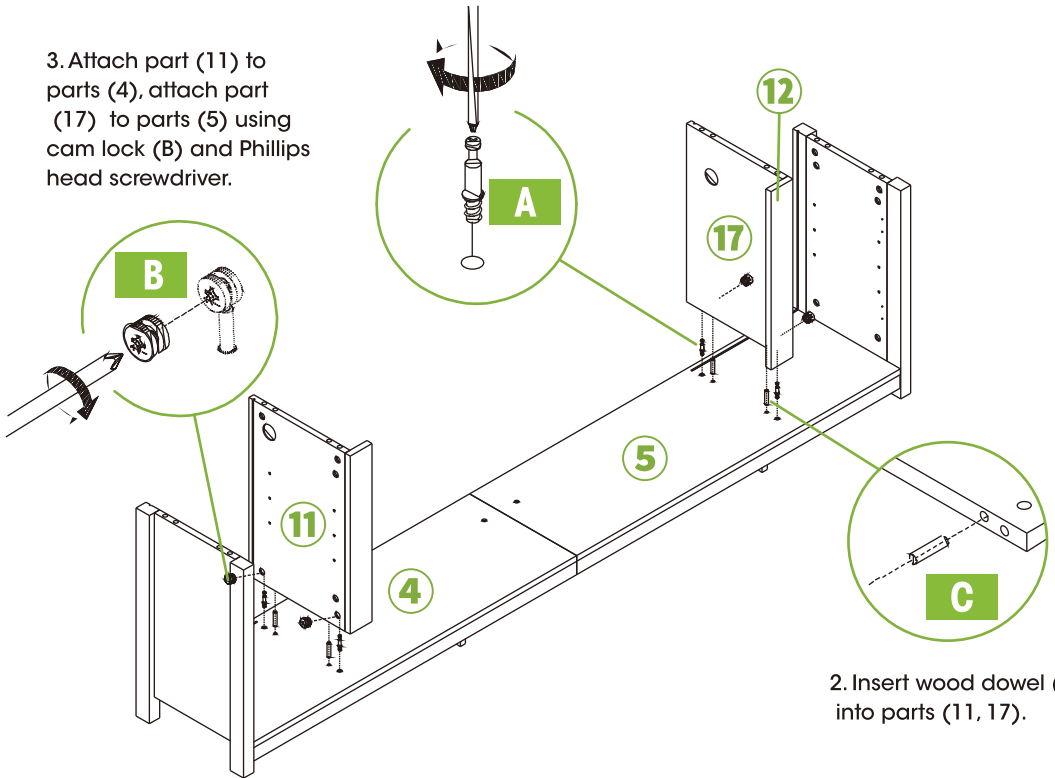

2. Insert wood dowel (C) into parts (11, 17).

## PRODUCT ASSEMBLY

8

Slide panel (13) into the grooves.

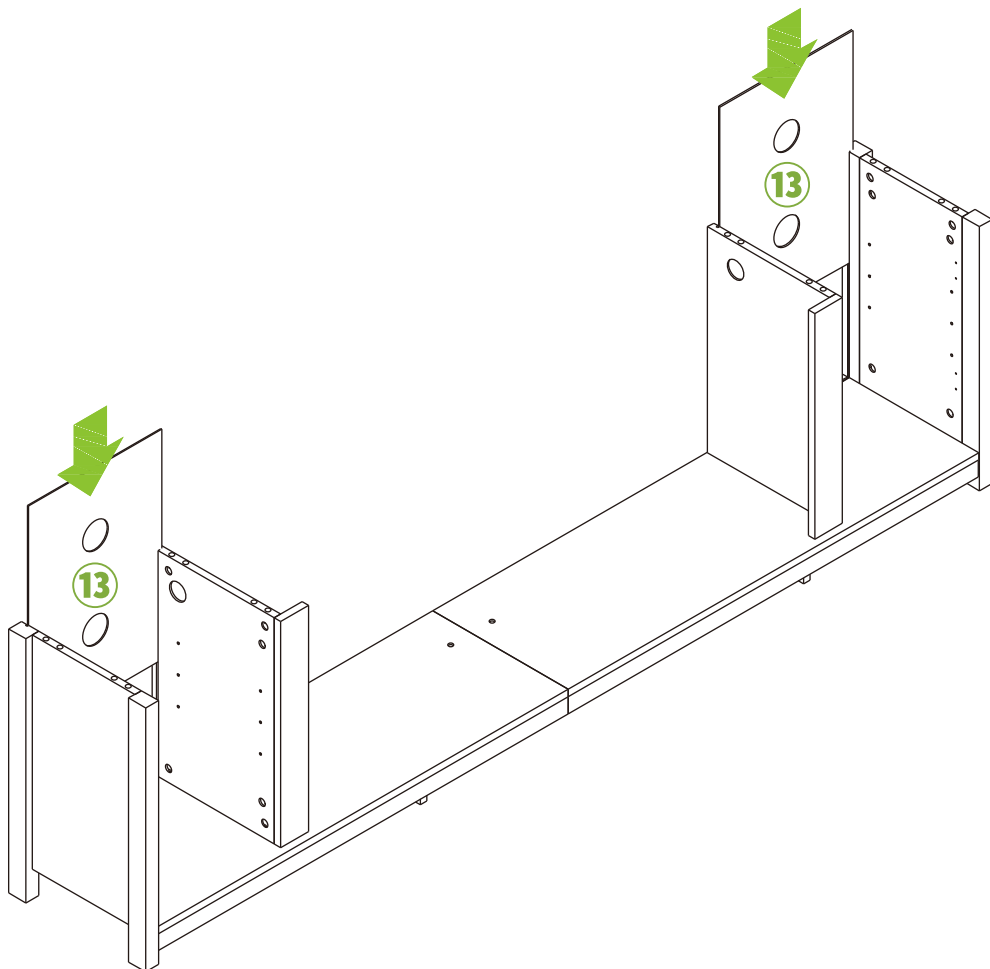

# PRODUCT ASSEMBLY

9

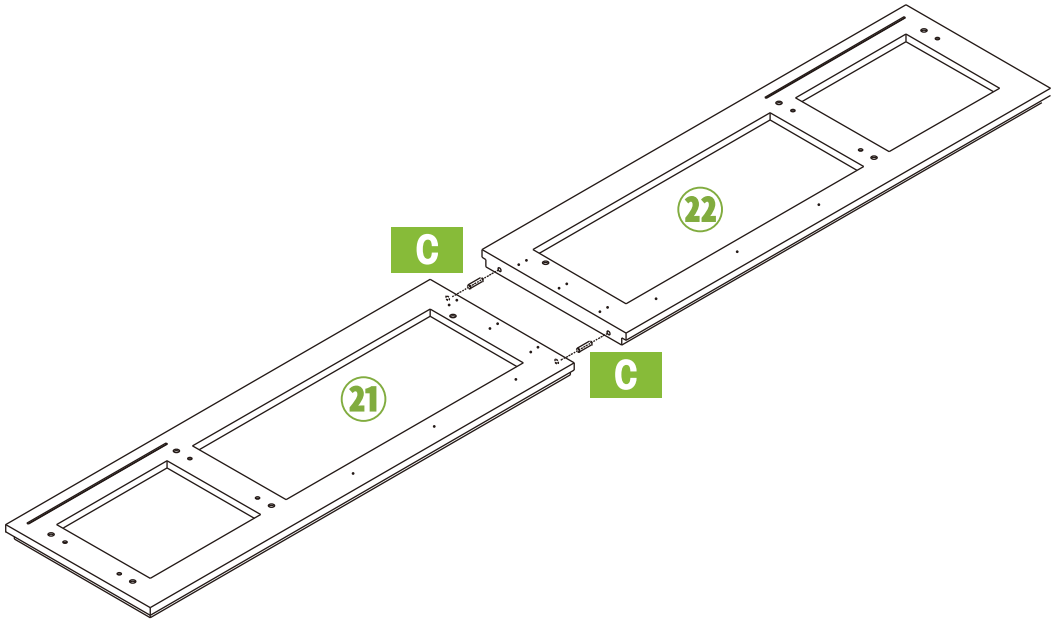

Insert wood dowel (C) into parts (21), (22). Attach parts (21) and (22).

PART	NO.	QTY.
	<b>C</b>	2



# PRODUCT ASSEMBLY

## 10

PART	NO.	QTY.
	<b>D</b>	16
	<b>E</b>	4
	<b>F</b>	6

2. Attach pieces (E) to secure the connection in parts (19) and part (20) using screw (D) and a Phillips head screwdriver.

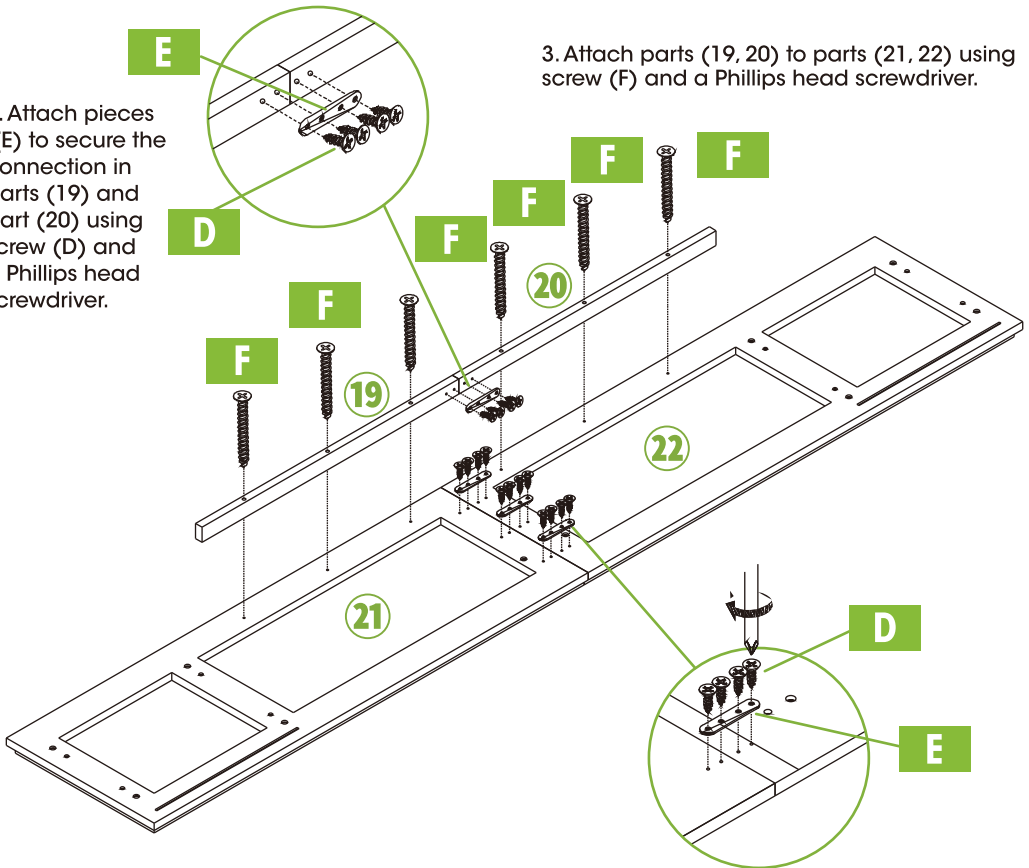

3. Attach parts (19, 20) to parts (21, 22) using screw (F) and a Phillips head screwdriver.



1. Attach pieces (E) to secure the connection in parts (21) and part (22) using screw (D) and a Phillips head screwdriver.

# PRODUCT ASSEMBLY

## 11

PART	NO.	QTY.
	<b>A</b>	2
	<b>B</b>	2

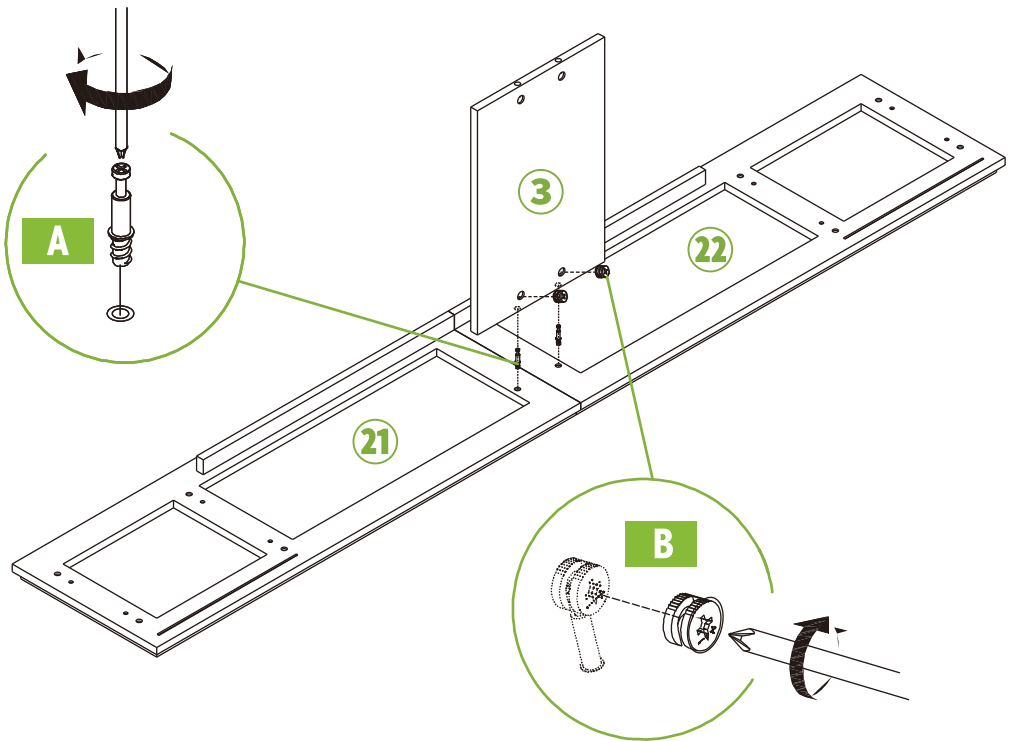

1. Insert cam bolt (A) into parts (21, 22).



2. Attach part (3) to parts (21, 22) using cam lock (B) and Phillips head screwdriver.

# PRODUCT ASSEMBLY

## 12

PART	NO.	QTY.
	<b>A</b>	10
	<b>B</b>	10
	<b>C</b>	8

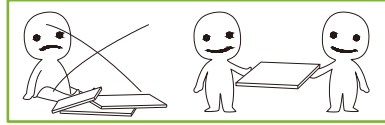

Require two people.

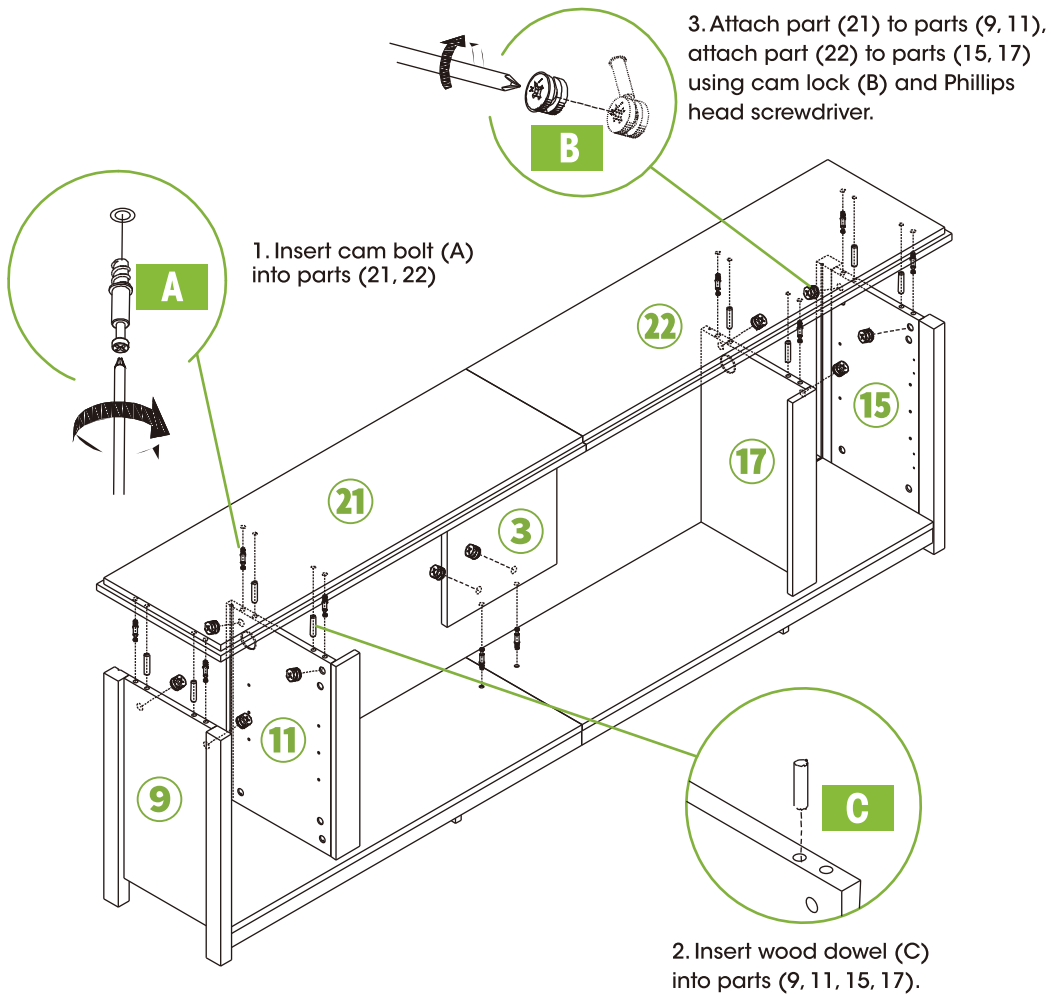

# PRODUCT ASSEMBLY

**13**

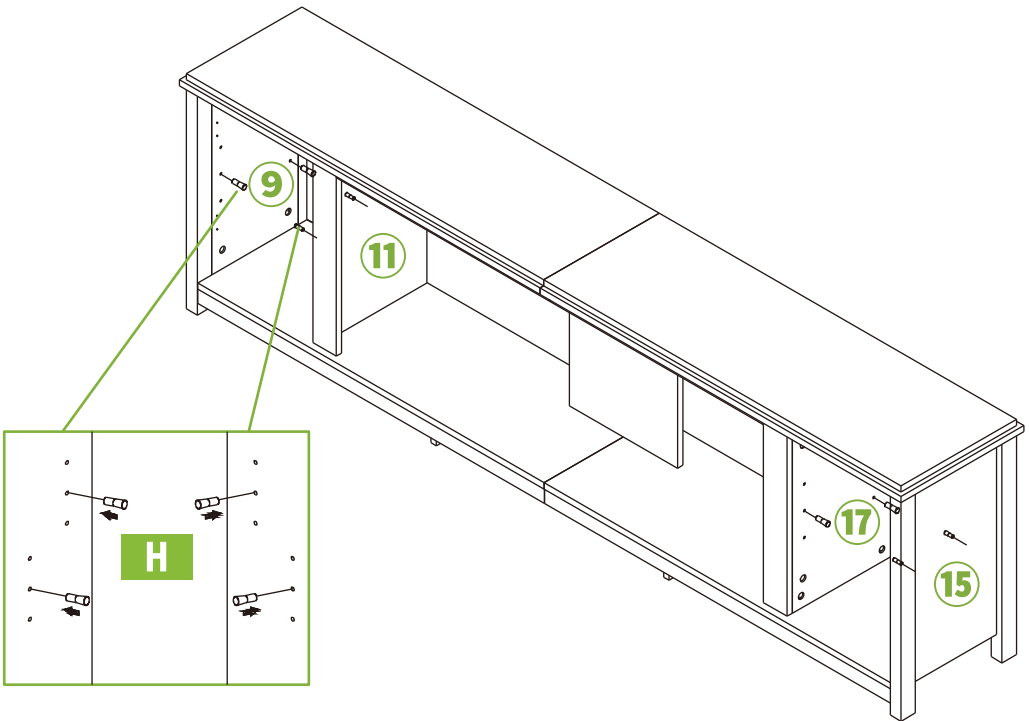

Insert shelf support pins (H) into parts (9, 11, 15, 17).

PART	NO.	QTY.
	<b>H</b>	8



# PRODUCT ASSEMBLY

## 14

PART	NO.	QTY.
	<b>D</b>	8
	<b>G</b>	4
	<b>J</b>	2

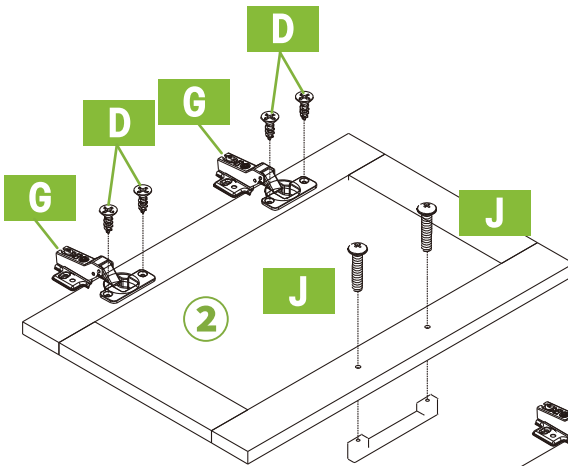

1. Insert door hinges (G) on part (2) using screw (D) and a Phillips head screwdriver.

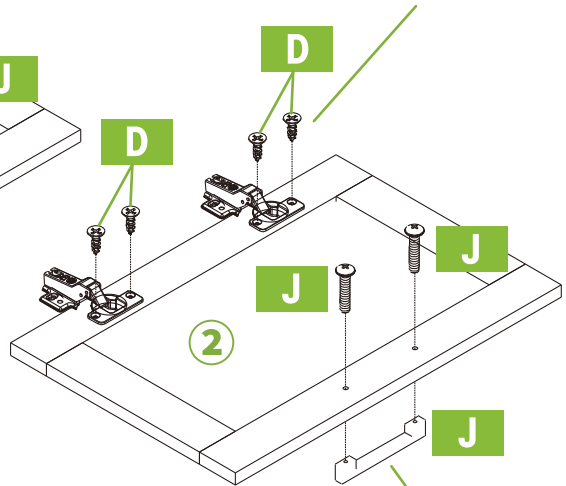

2. Insert door handles (J) on part (2) using screw (J) and a Phillips head screwdriver.

# PRODUCT ASSEMBLY

## 15

Attach part (2) to parts (9, 15) using screw (D) and a Phillips head screwdriver.

PART	NO.	QTY.
	<b>D</b>	16

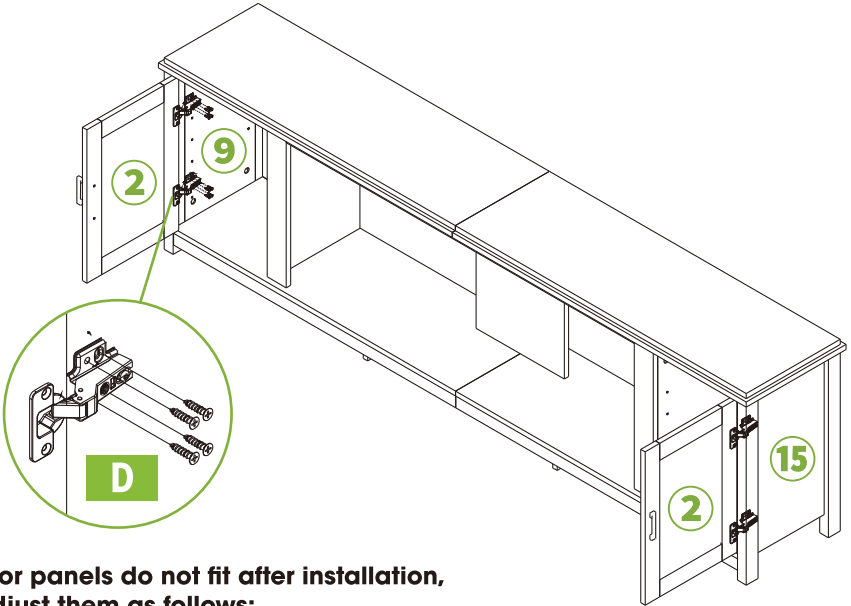

**If your door panels do not fit after installation, please adjust them as follows:**

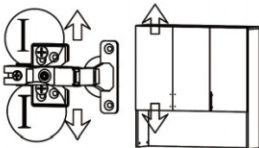

I: Adjust the screws at I to move the hinge up and down to adjust the up and down position of the door panel.

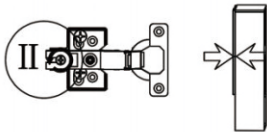

II: Adjust the screws at II to adjust the distance between the door panel and the vertical panel.

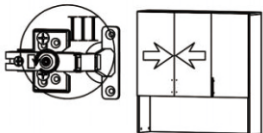

III: Adjust the screws at III to adjust the distance between the door panels

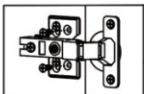

Tighten the screws again after adjustment.

# PRODUCT ASSEMBLY

## 16

PART	NO.	QTY.
	<b>K</b>	2

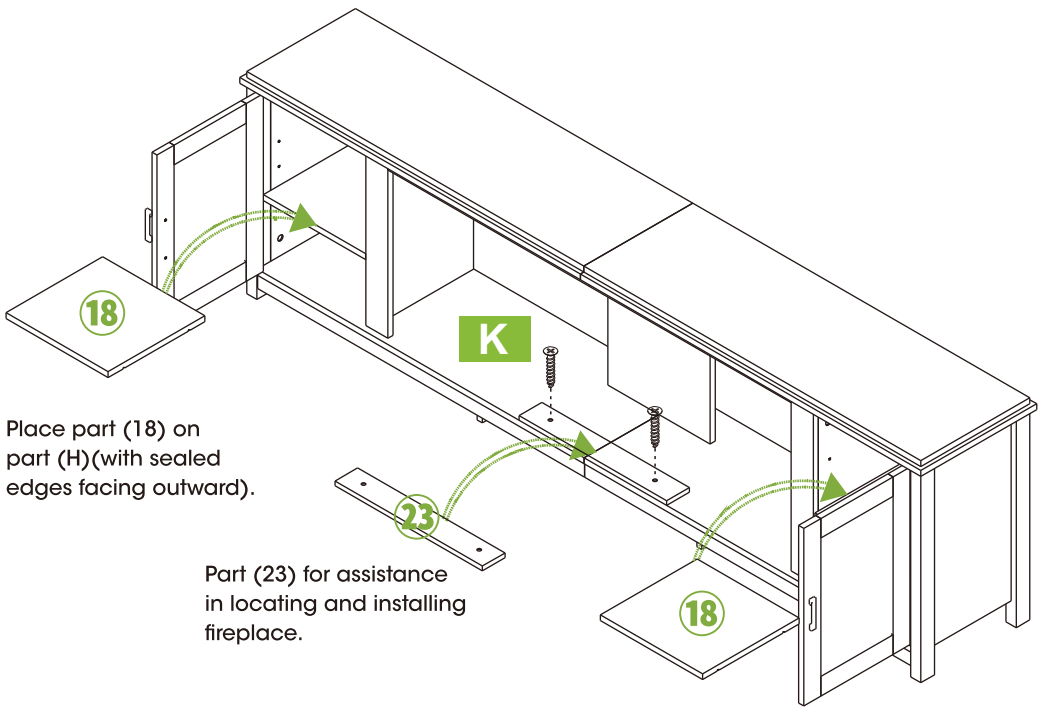

Place part (18) on part (H)(with sealed edges facing outward).

Part (23) for assistance in locating and installing fireplace.

## PRODUCT ASSEMBLY

17

**NOTE: Dear customer, if you purchase a TV stand & fireplace set, the package for the fireplace and the package for the TV stand will be delivered separately. If you purchase only the TV stand, the fireplace is not included.**

Remove four silver screws from the sides of the heater (two screws on each side)  
Remove the tempered glass by lifting it from the lugs on the side.

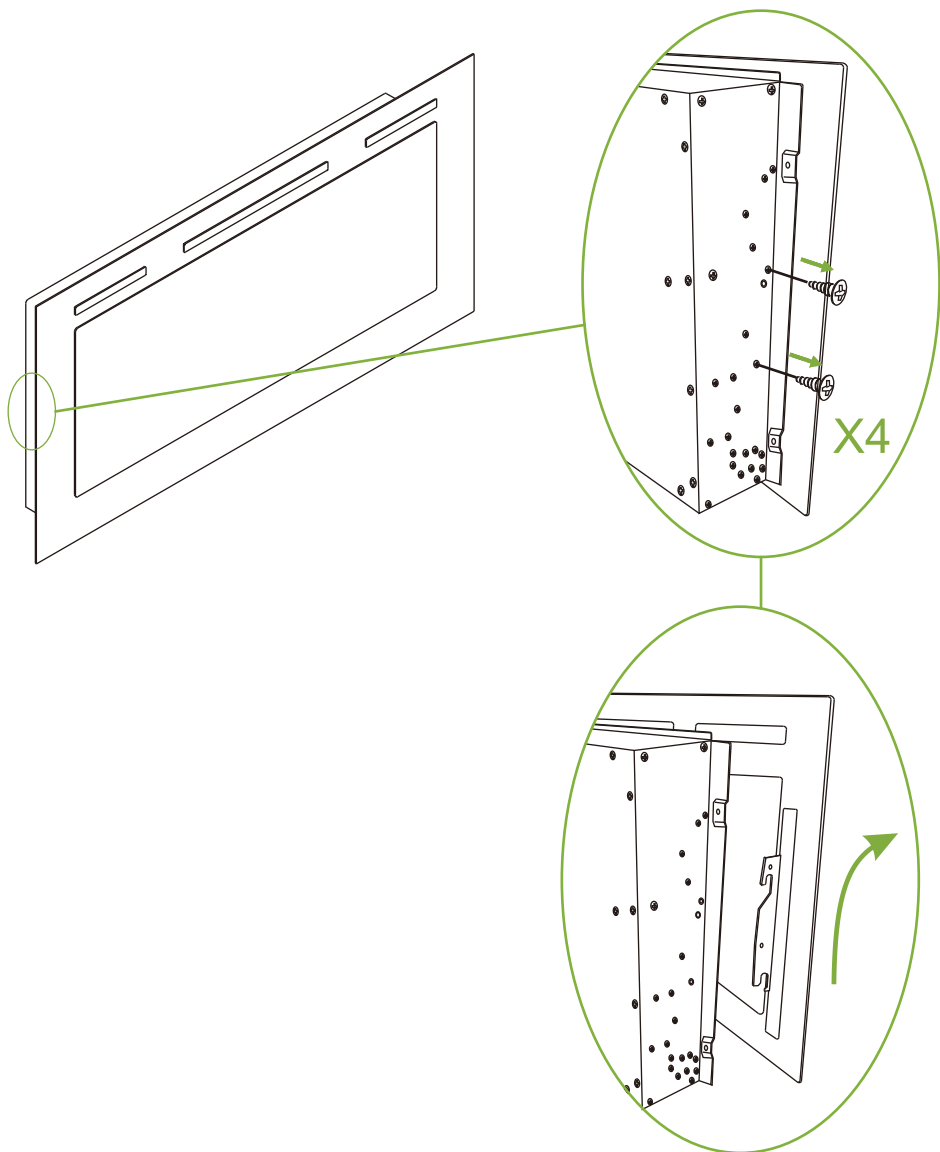

Remove the fireplace panel.

## PRODUCT ASSEMBLY

18

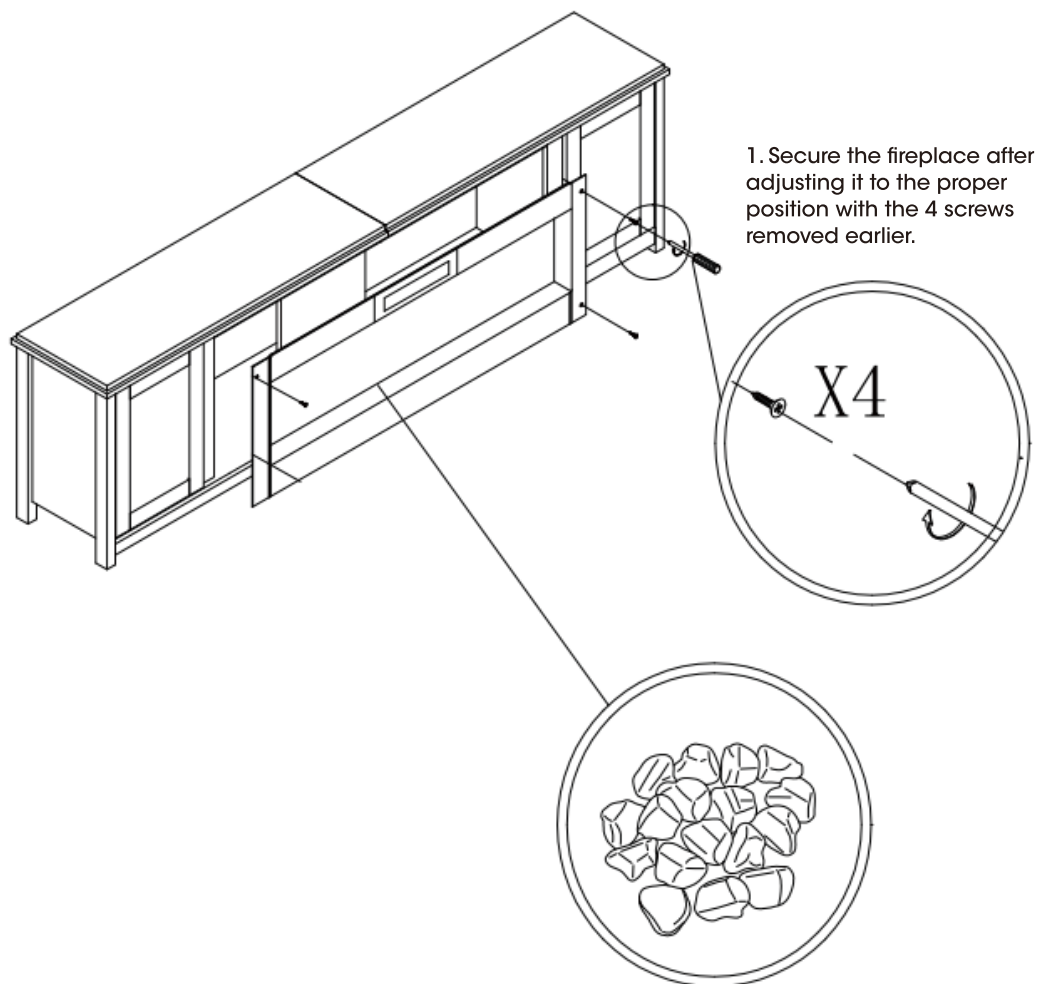

2. Place the crystal stones in the groove of the fireplace.

## PRODUCT ASSEMBLY

19

Place the front glass surround over the front of the fire aligning the slot in the bracket at each side of the glass panel with the lugs on the sides of the fire.

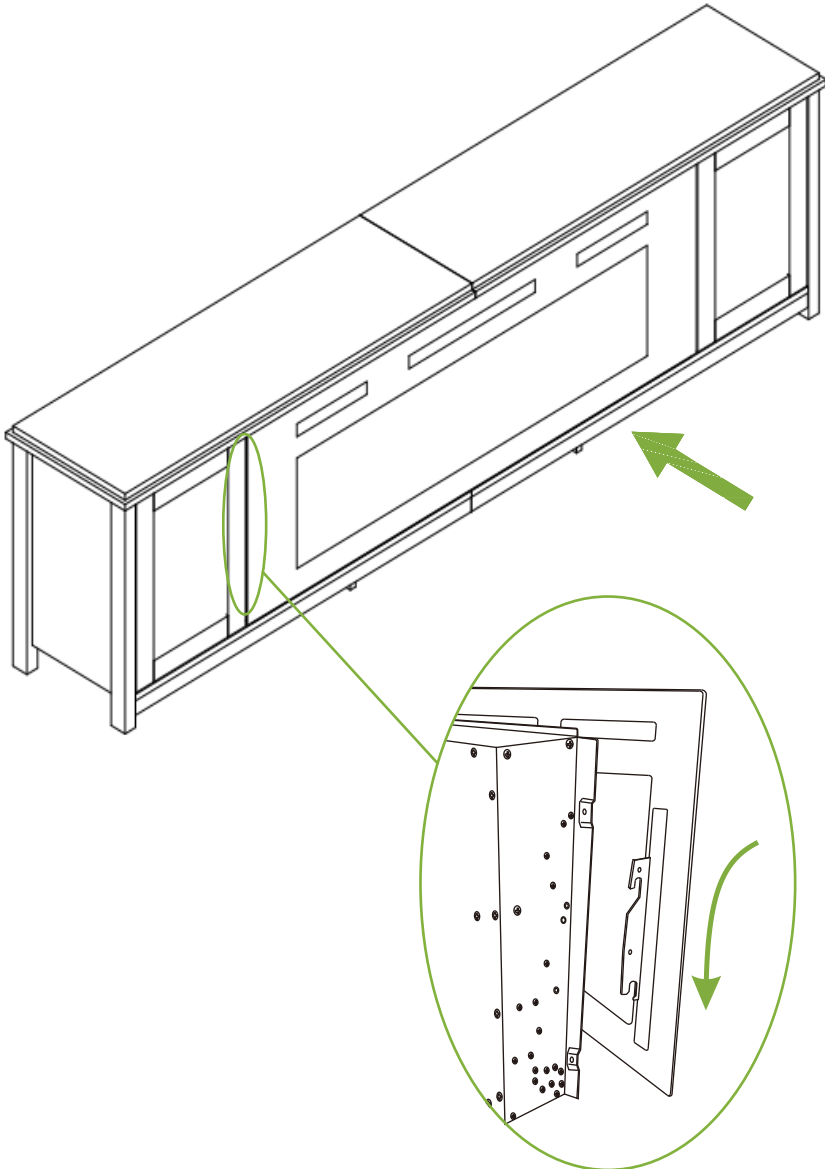

Put the fireplace panel back on.