

# ASSEMBLY INSTRUCTIONS

## DINING CHAIR

Please read instructions carefully







Remove all wrapping materials, staples and packing straps from the carton. Refer to Parts List and Hardware List and ensure they are complete before you start assembling. Place all wooden parts on a clean, flat and soft surface (e.g carpet or rug) to prevent parts from being scratched.

- CAUTIONS:
- 1) DO NOT FULLY TIGHTEN BOLTS AND NUTS UNTIL ALL PARTS HAVE BEEN ASSEMBLED.
  - 2) DO NOT OVER-TIGHTEN BOLTS AND NUTS UNTIL ALL PARTS HAVE BEEN ASSEMBLED.
  - 3) KEEP ALL HARDWARE PARTS OUT OF REACH CHILDREN.

### PARTS LIST (FOR 2 NOS. OF CHAIR)

	PARTS	QTY.
P1	SEAT	2
P2	FRONT LEG	4
P3	BACKLEG FRAME	2

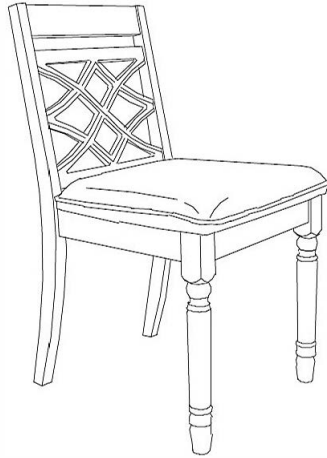

### HARDWARE LIST (FOR 2 NOS. OF CHAIR)

	DESCRIPTION	QTY.
H1	M6 x 35mm JCBC SCREW 	4
H2	M6 x 80mm JCBC SCREW 	16
H3	SPRING WASHER 	20
H4	FLAT WASHER 	20
H5	ALLEN KEY 	1
H6	NAIL LEG 	8





COMPLETE ASSEMBLY

### STEP 1

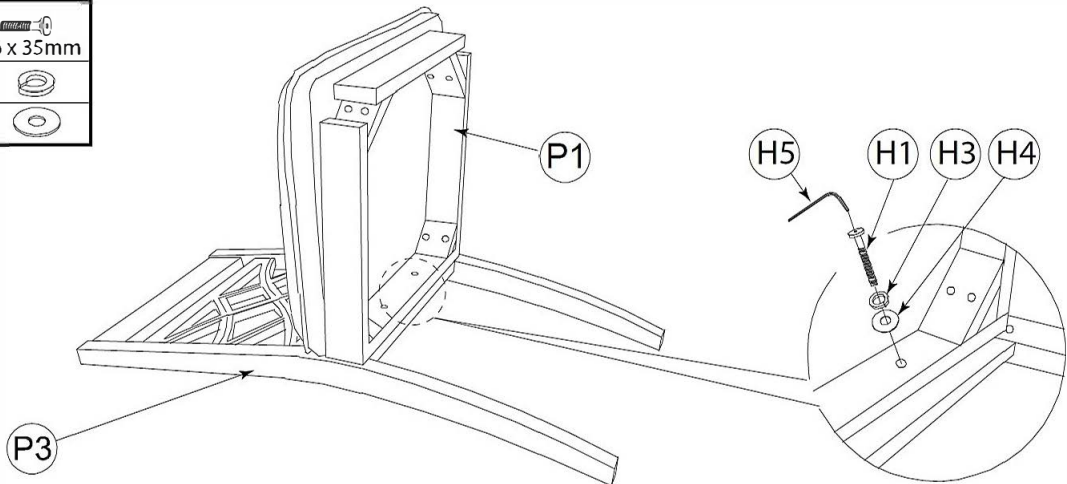
H1 x 2	 M6 x 35mm
H3 x 2	
H4 x 2	



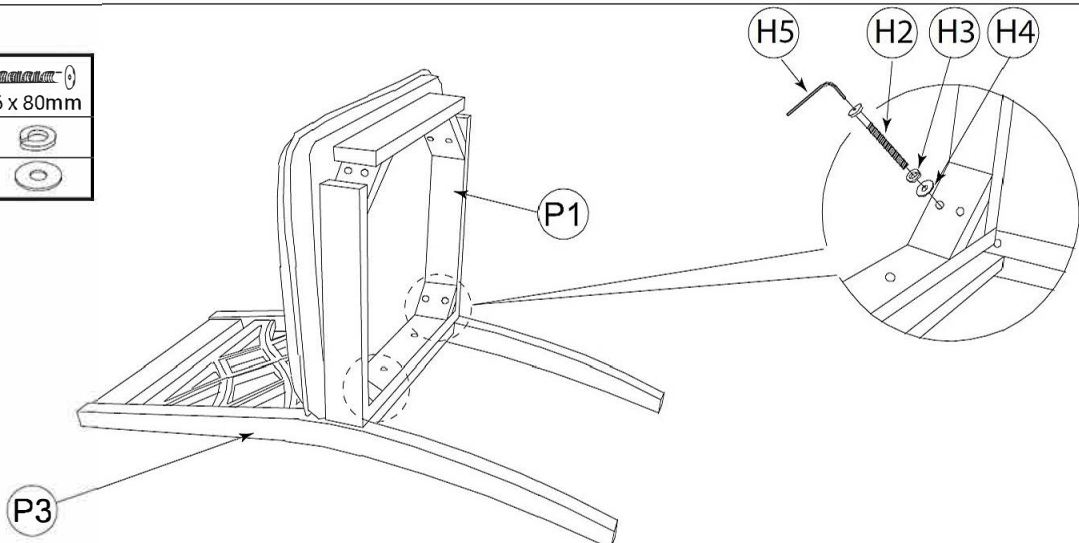

### STEP 2

H2 x 4	 M6 x 80mm
H3 x 4	
H4 x 4	

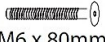

### STEP 3

H2 x 4	
M6 x 80mm	
H3 x 4	
H4 x 4	

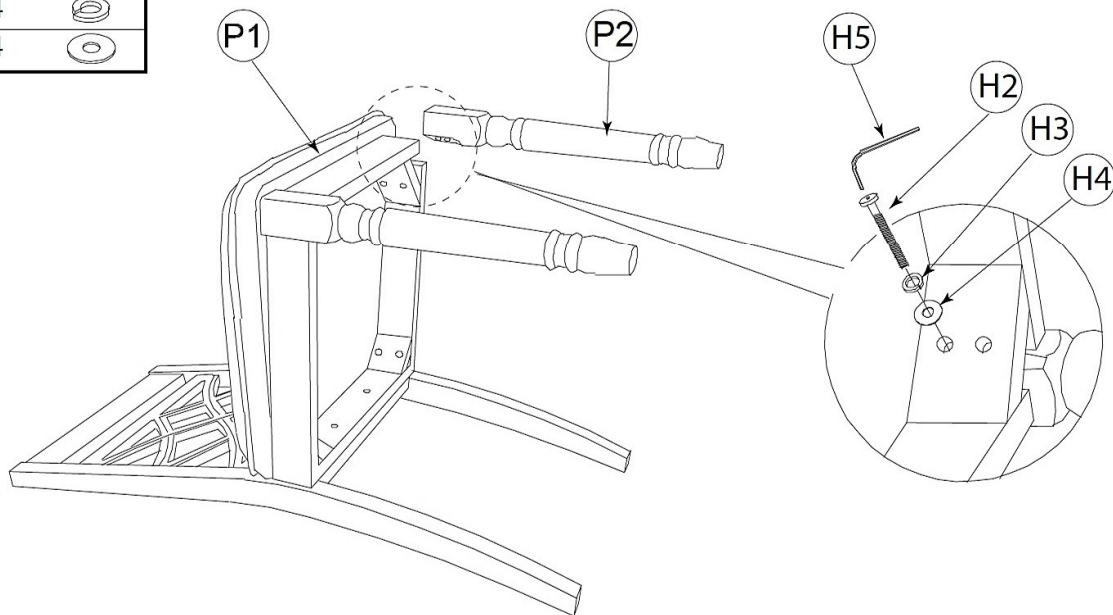

### STEP 4

H6 x 4	
--------	--

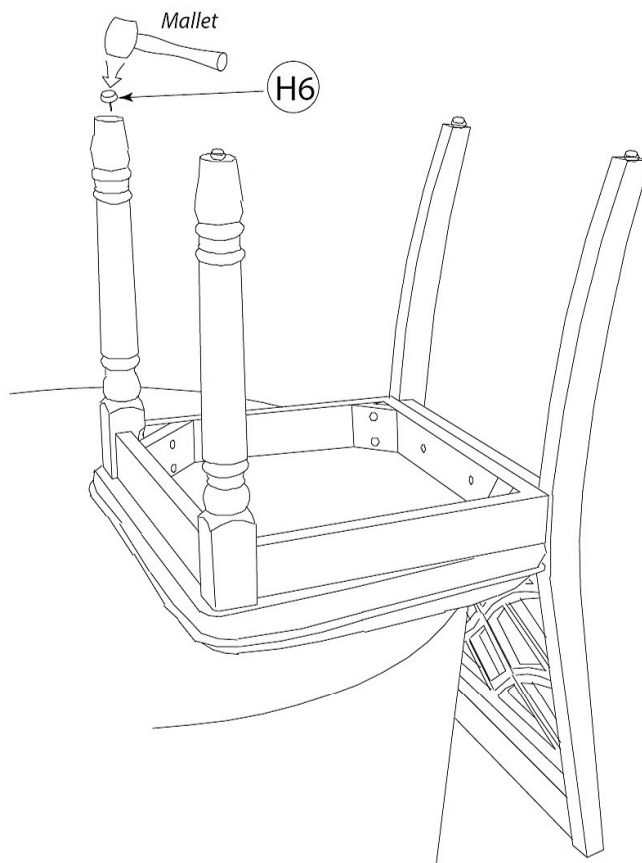

#### CARE AND MAINTENANCE

- SAFETY** - To avoid any risk of suffocation to children and animals, dispose off plastic bags immediately.
- CLEANING** - Clean with damp cloth and mild detergent. Do not use bleach or abrasive products.
- FITTINGS** - tighten bolts and nuts from time to time to ensure all parts of product are securely fitted.