

ASSEMBLY INSTRUCTIONS

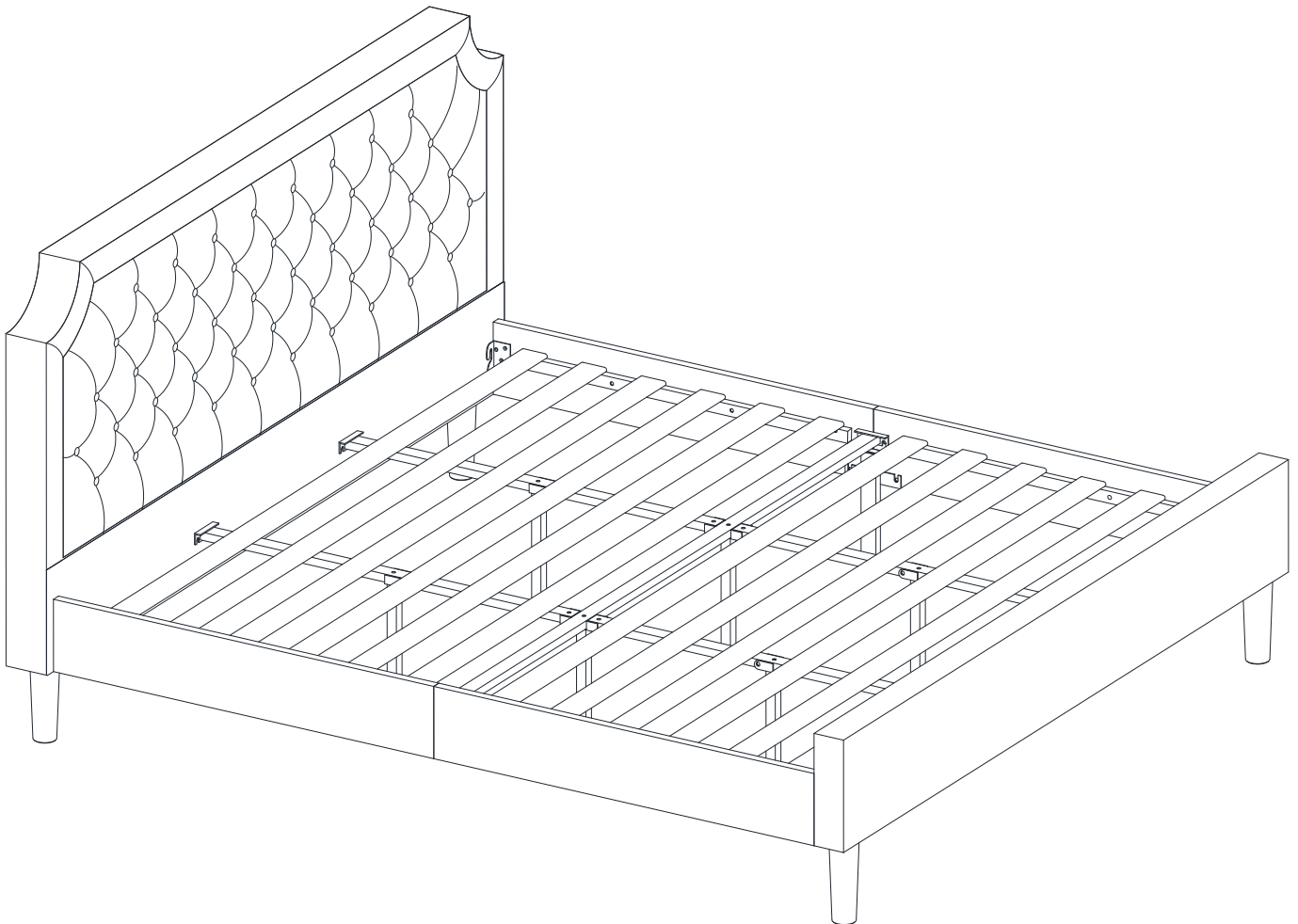

Product Dimension : 81"Wx89"Lx47"H

Cube Size : 82.8"x40,7"x6.2"

NW: 127.6 LBS

GW: 138.6 LBS

BEFORE ASSEMBLY

Thank you for purchasing this quality product. This product has been designed for easy assembly and constructed for durability. Please take the time to read and follow the assembly instructions carefully.

Be sure to check all packing material carefully for small parts which may have come loose inside the carton during shipment. Please separate, identify, and count all parts and metal hardware. Compare with part list to be sure all parts are present.



If hardware is missing or you have difficulty assembling this product, please call for us.

IMPORTANT NOTE:

- Place all wooden parts on a clean and smooth surface such as a rug or carpet to avoid the parts from being scratched.
- Remove all wrapping material, including staples & packing straps before you start to assemble.
- DO NOT tighten all screws and bolts until completely assembled.
- Keep all hardware parts out of reach of children.



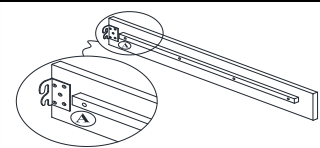
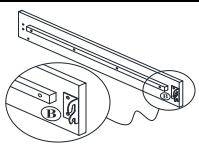
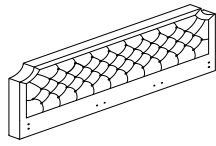
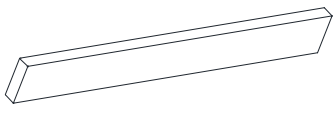

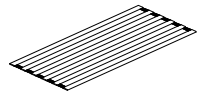
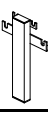
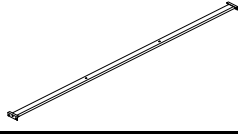
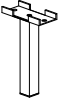
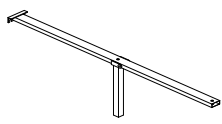

PART LIST

When unpacking, please be careful not to discard any parts with the packaging. Before continuing, please make sure you have the following parts:

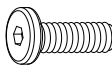
NO	Description	Qty	Sketch	NO	Description	Qty	Sketch
A	Side rails	2		B	Side rails	2	
C	Headboard	1		D	Footboard	1	
E	Leg	4		F	Slats	2	
G	Center suport Leg	2		H	Horizontal support frame	1	
K	U-bracket	2		L	Center Support Rail	4	

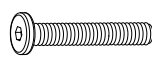
HARDWARE LIST

When unpacking, please be careful not to discard any parts with the packaging. Before continuing, please make sure you have all of the following hardware:

NO	Description	Qty	Sketch	NO	Description	Qty	Sketch
1	Medium bolt (M8x20mm)	8		2	Short bolt (M6x15mm)	20	
3	Long bolt (M6x30mm)	10		4	Lock washer (Φ8.5xΦ13mm)	8	
5	Flat washer (Φ8.5xΦ19mm)	8		6	Allen key	1	

STEP 1

Attach the legs (E) to the bottom of the headboard (C). as shown below.

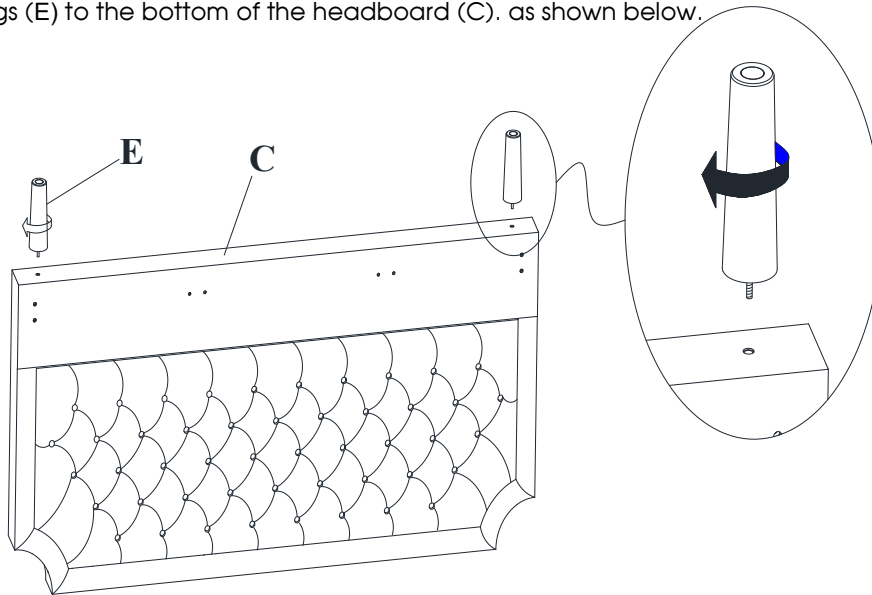

STEP 2

Attach the legs (E) to the bottom of the footboard (D). as shown below.

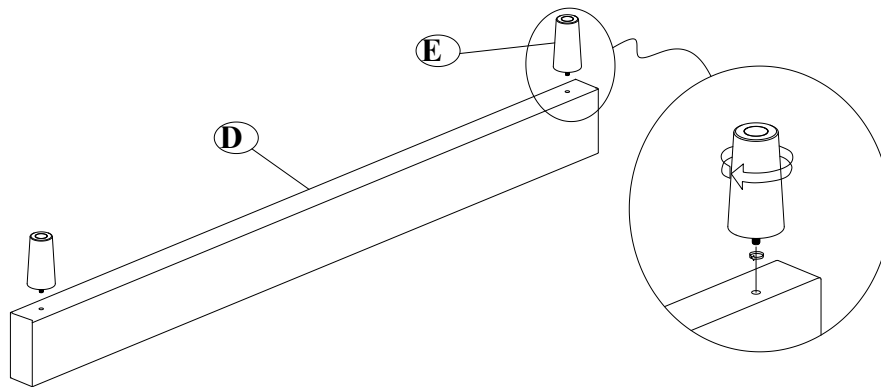

STEP 3

Assemble the Side rails by joining the (A) & (B) side rail using Center support leg (G), and Short Bolts (2), Tighten with Allen key (6). Apply for both left and right side.

NOTE: Make sure the support slat piece on the Center support leg (G) are completely contacted with the bottom of the side rails (A), (B) before tightening the bolts.

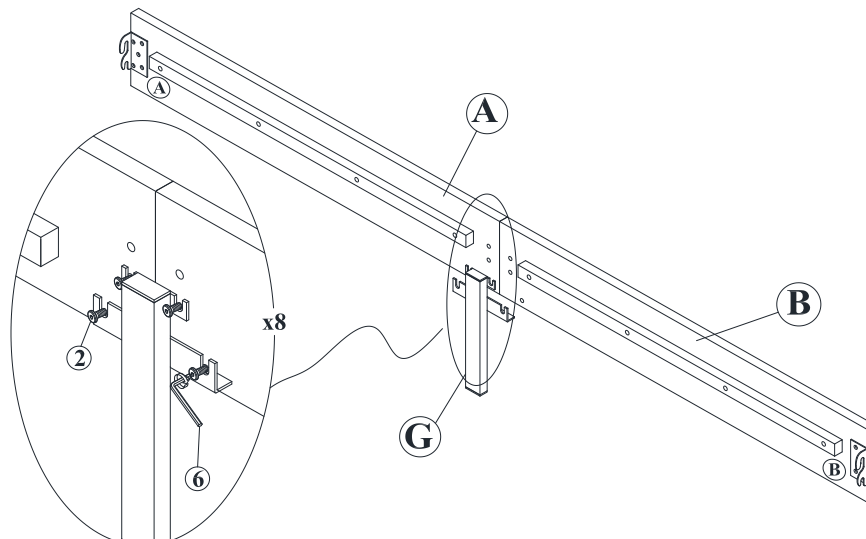

STEP 4

Attach the Headboard to the assemble side rails using Medium bolts (1) and Washers (4) and Lock Washers (5) on the both sides. Repeat for the Footboard. Tighten with Allen key (6).

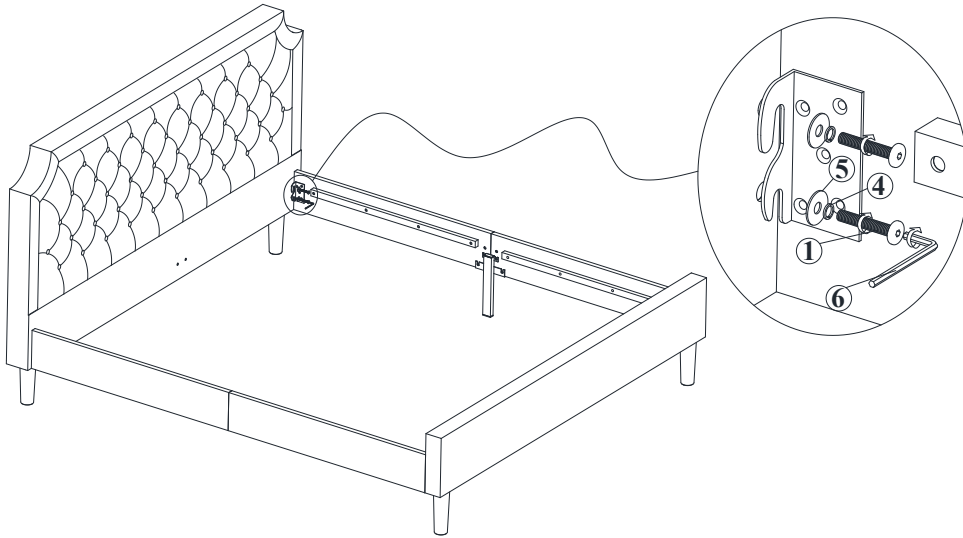

STEP 5

Attach U-bracket (K) to the Horizontal support frame (H) using Long bolts (3) Tighten with Allen key (6)

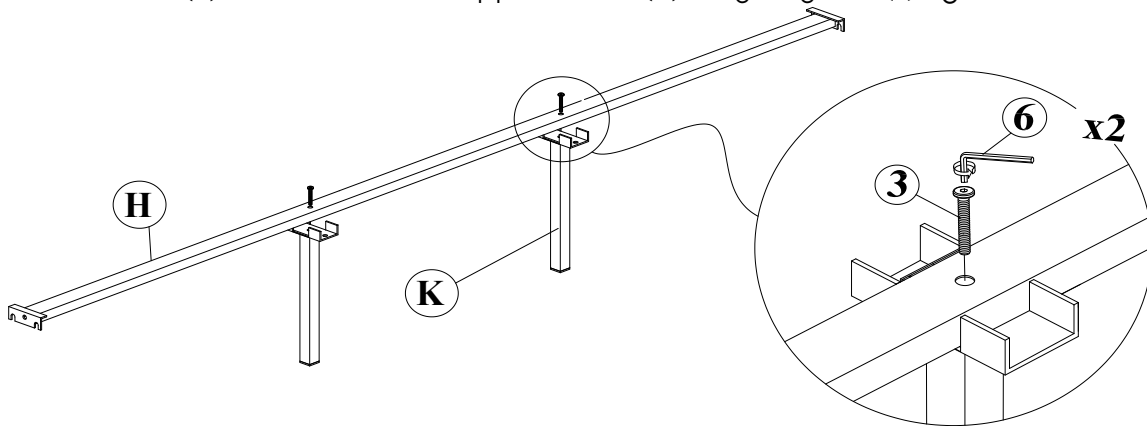

STEP 6

Attach the Horizontal support frame (on step 4) to the side rails by using Short bolts (2) Tighten with Allen key (6)

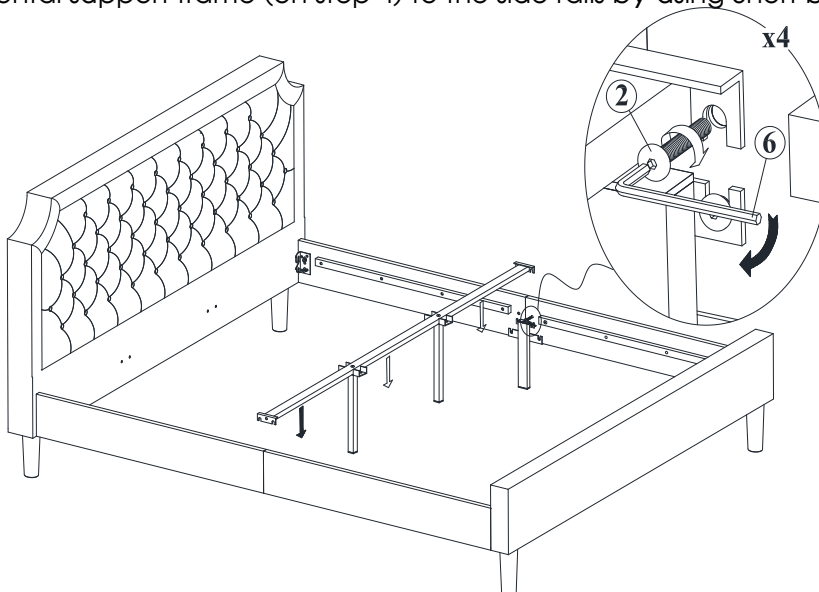

STEP 7

Attach Center Support Rail (L) to Headboard & footboard (on step 6) using the Short bolts (2) & Long bolts (3) Tighten with Allen key (6)

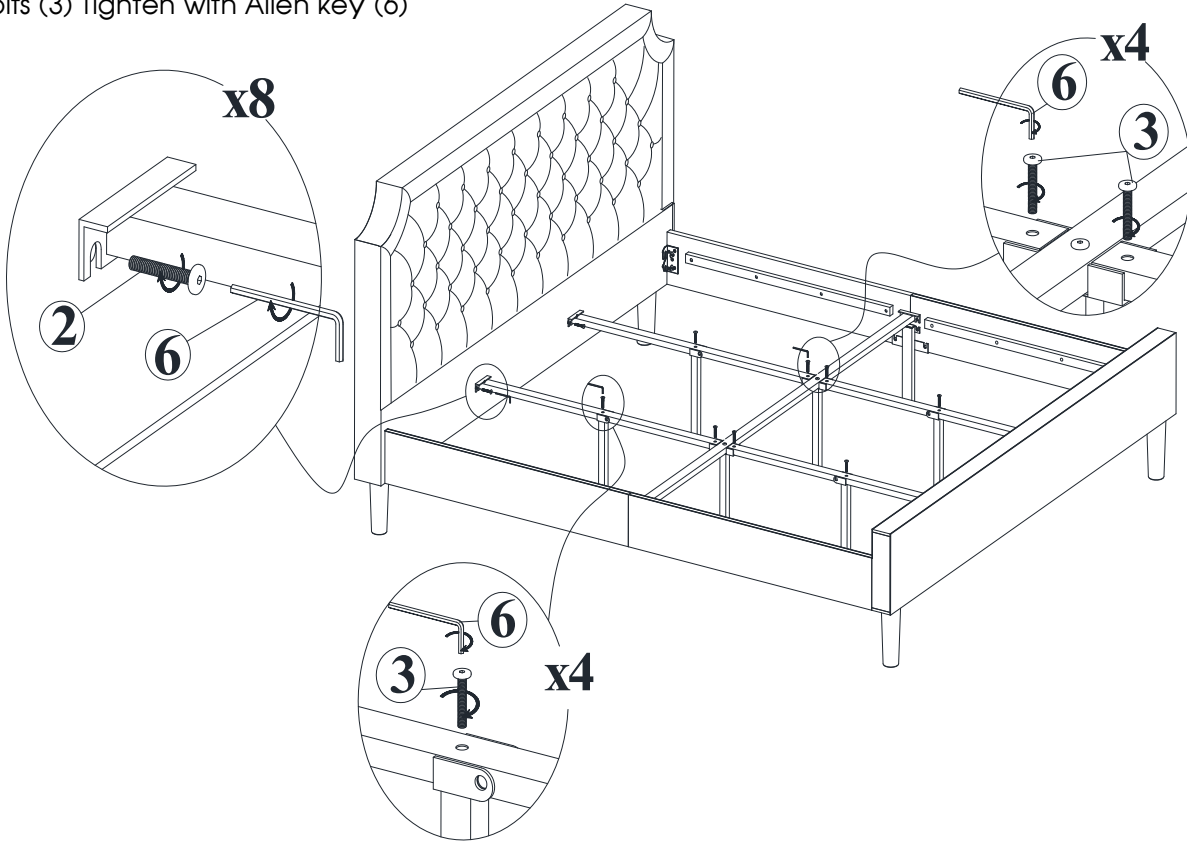

STEP 8

Place the Slats (F) on the bed frames, and complete the assembly.

