

# WARNING

- \* Switch off the main electrical supply from the main fuse box / circuit.
- \* Breaker before installation.
- \* Inspect item carefully before attempting to install.
- \* If there is any damages or obvious defects, do not install.
- \* Item may not be returned once it has been installed.

# CARE AND MAINTENANCE

- \* To clean the outside of the fixture, use a dry or slightly dampened clean cloth (use clean water, never a solvent) to wipe the surface of the fixture.
- \* To clean the inside of the fixture, first disconnect power to the fixture by turning off the circuit breaker or by removing the fuse at the fuse box. Next, use a dry or slightly dampened clean cloth (use clean water, never a solvent) to wipe the interior surface of the fixture.
- \* Do not use any cleaners with chemical, solvents or harsh abrasives. Use only a dry soft cloth to dust or wipe carefully.







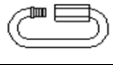
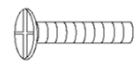
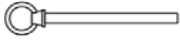

# NOTICE& IMPORTANT SAFETY INSTRUCTIONS

\*\* WE RECOMMEND INSTALLATION OF THIS LIGHTING FIXTURE BE DONE BY A LICENSED ELECTRICIAN \*\*\* \*

Please make sure that you have all parts indicated before you begin assembly of this item

- \* This item should be assembled on a soft surface to prevent scratching the finish during assembly
- \* To reduce the risk of fire, electrical shock or injury to persons or property, please follow the guideline below for safe use and installation
- \*The external flexible cable or cord of this lamp cannot be replaced  
If the cord is damaged, the lamp shall be destroyed

## Part List and Hardware List

PIECE	DESCRIPTION	PICTURE	QUANTITY	PIECE	DESCRIPTION	PICTURE	QUANTITY
A	Wire Nut		3X	G	Closable Link		2X
B	Mounting Screw		2X	H	Fixture Loop+tube		2X
C	Mounting Plate		1X	I	Twine tube		2X
D	Bulb		5X	J	long tube		4X
E	Canopy		1X	K	shade		1X
F	Canopy Screw		4X	L	Socket Assembly		1X

**Product Dimensions: 39.75"L x 11.75"W x 18-48"H**

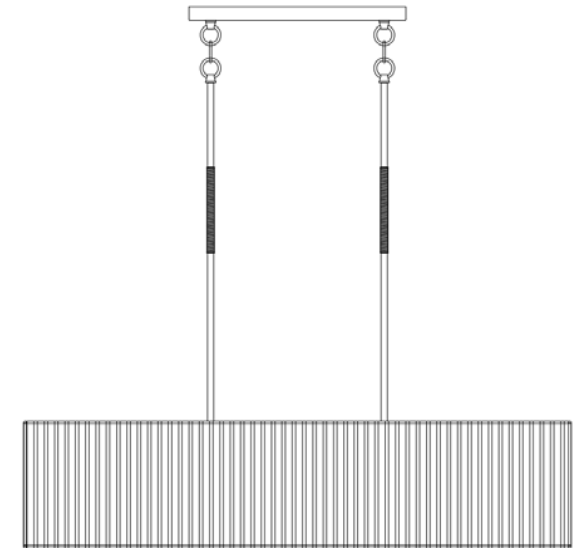

## PREPARATION

- \* Before beginning assembly of product, make sure all parts are present. Compare parts with package contents list and hardware contents list.
- \* If any part is missing or damaged, do not attempt to assemble the product.
- \* Estimated Assembly Time: 30 minutes.
- \* If you are having difficulty, our friendly Customer Care team is always here to help

**NOTE: PLEASE USE TYPE "A" BULB MAX 40-WATT OR LED BULB MAX 9-WATT, THERE ARE 5\*LED 4-WATT BULBS IN THE BOX**

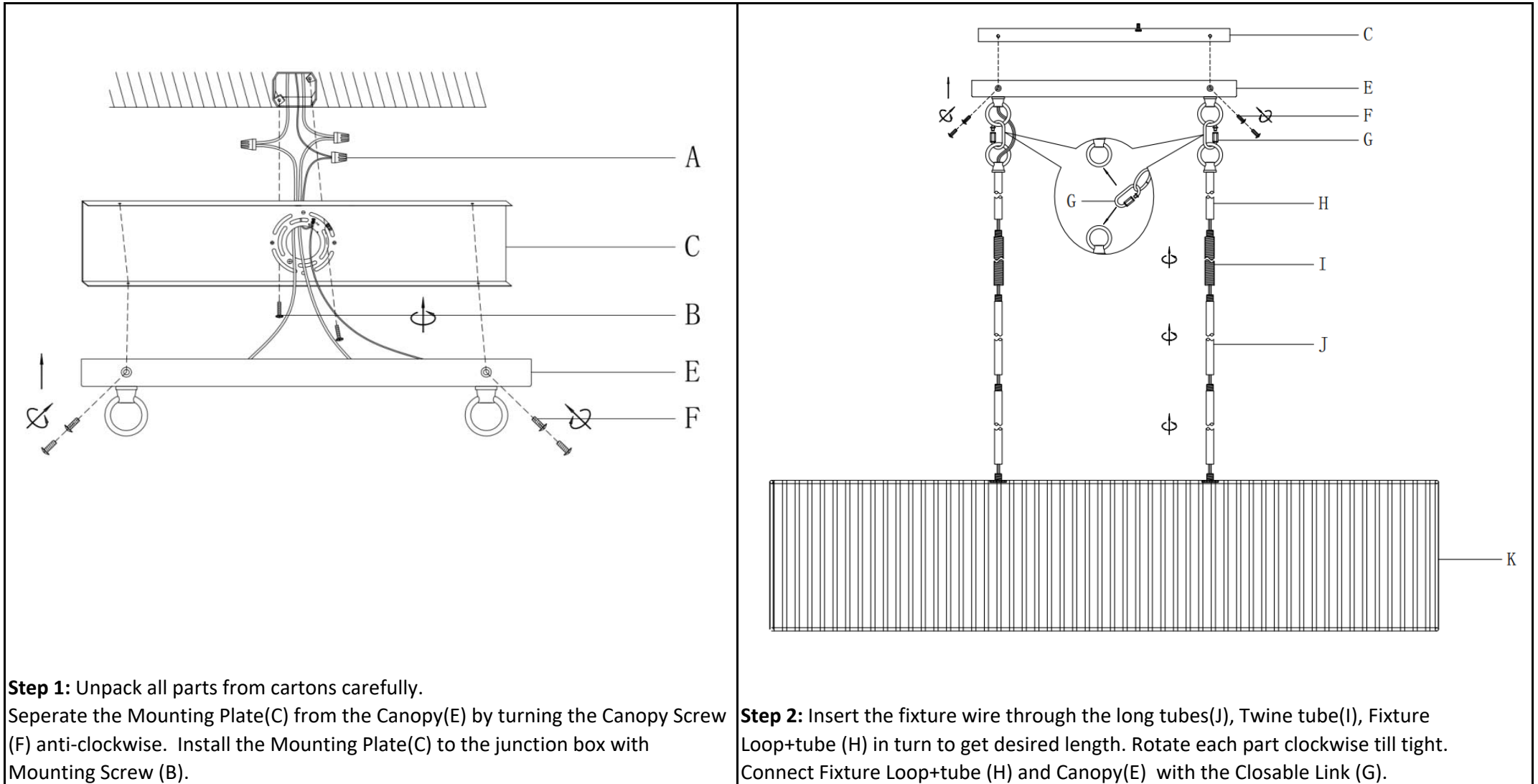

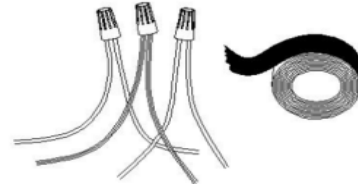
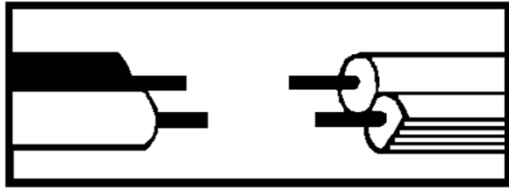

**Step 3: Wire connection**

Connect fixture neutral wire (ribbed) to the outlet box neutral wire (usually white) using a wire nut. Connect fixture hot wire (smooth with markings) to the outlet box hot wire (usually black) using a wire nut.

CAUTION: Do not reverse the hot and neutral connections

**Grounding Instructions:**

Wrap ground wire from outlet box around green ground screw on mounting bracket, no less than 2" from wire end. Tighten ground screw. If fixture is supplied with a ground wire, connect to outlet ground wire with a wire nut.

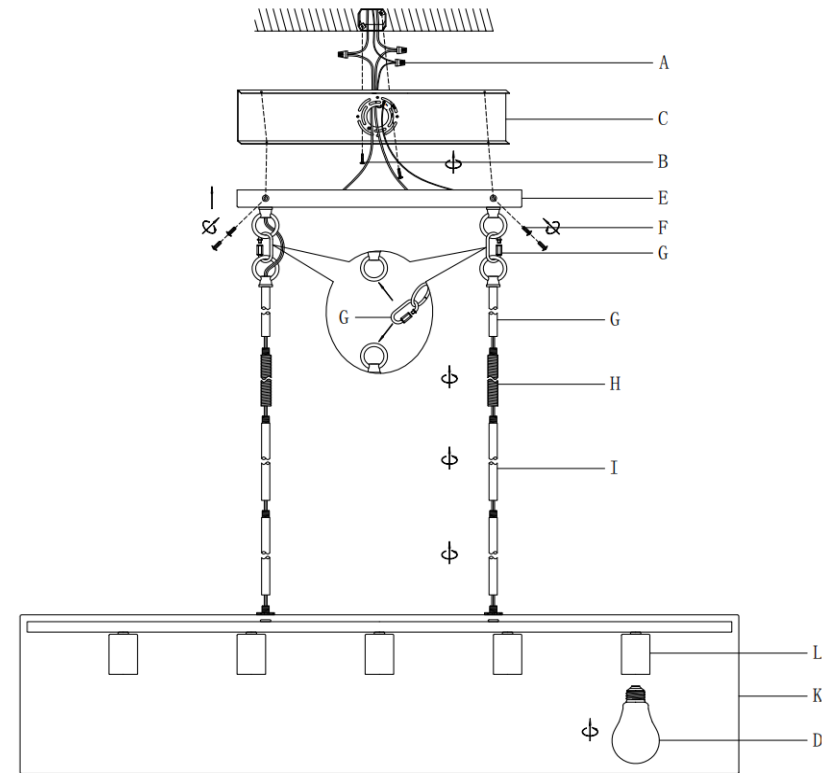

**Step 4:** Attach the Canopy(E) to the junction box and fix it by turning the Canopy Screw(F) clockwise. Insert the bulbs (D) into the Sockets(L).