

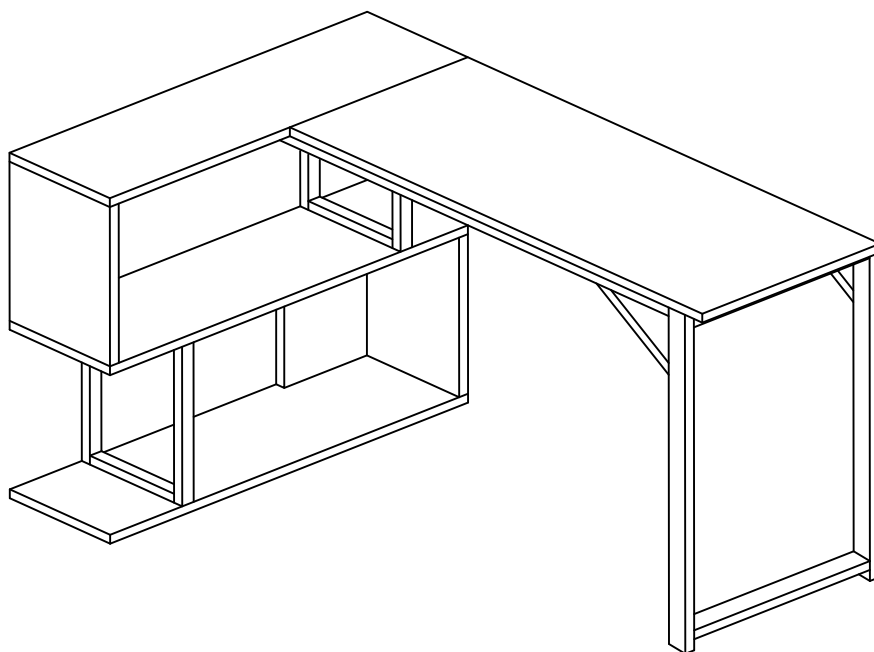

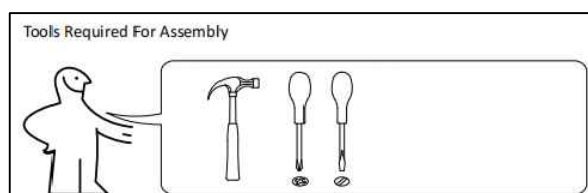

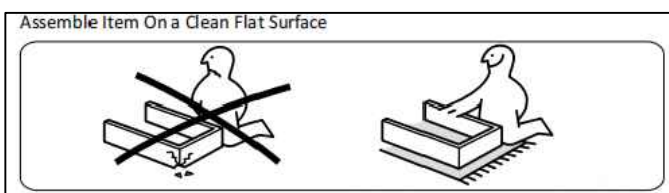



# Instruction Manual







DEAR CUSTOMER,  
Thank you for choosing our product. Please read this manual carefully before assembling. If the product is passed on to the third party, this manual has to be passed on along with the product. Enjoy your new purchase!



## HARDWARE LIST

1		2		3	(M6*20)	4	(M8*40)	5	(M6*35)
									
	x16pcs		x16pcs		x8pcs		x2pcs		x12pcs

<p>6</p>  <p>x4pcs</p>	<p>7</p>  <p>x4pcs</p>	<p>8</p>  <p>x16pcs</p>	<p>9</p>  <p>x2pcs</p>	
---	---	--	---	--

## PARTS LIST

Note: there will be some error in the measurement, the actual size shall prevail.

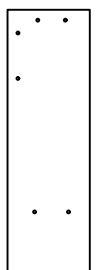
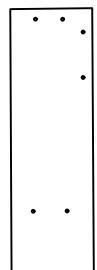
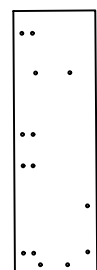
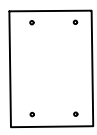
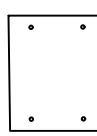
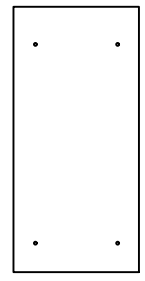
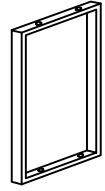
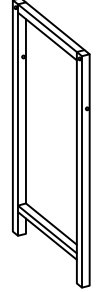
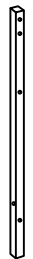
<p>A</p>  <p>x1pc</p>	<p>B</p>  <p>(with holes on the back) x1pc</p>	<p>C</p>  <p>x1pc</p>	<p>D</p>  <p>x2pcs</p>
<p>E</p>  <p>x2pcs</p>	<p>F</p>  <p>x1pc</p>	<p>G</p>  <p>x2pcs</p>	<p>H</p>  <p>x1pc</p>
<p>I</p>  <p>x2pcs</p>			

## NOTE

- Please check that you have all the parts and hardware listed before assembling.
- Please do not tighten all bolts until the table is assembled completely.
- If you find that something is missing, please contact the store you purchase immediately.
- At least every 4 months, check all bolts, screws and knobs to be sure they are tight.

# Screws Installation Steps

- |  |  |
|--|--|
| 1<br><br>×16pcs | 2<br><br>×16pcs |
|--|--|

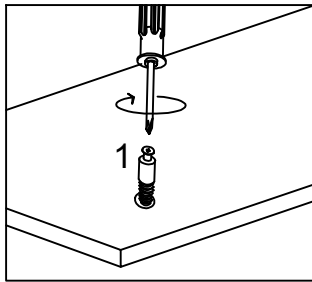

Screw the eccentric screw onto the board.

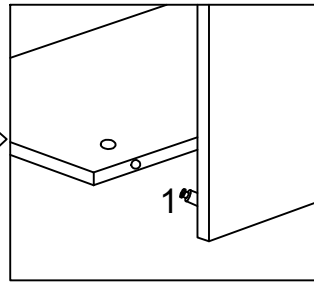

Find the corresponding board to insert.

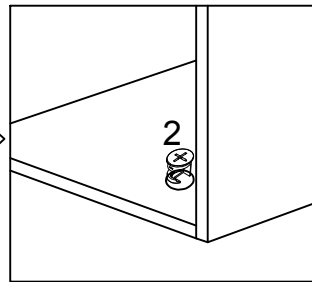

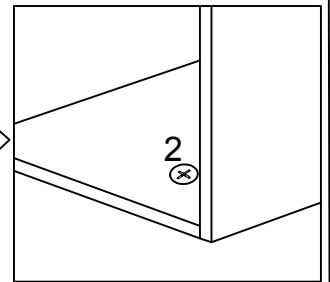

Insert eccentric bolt into round hole.



Turn clockwise about 180° to lock the board.

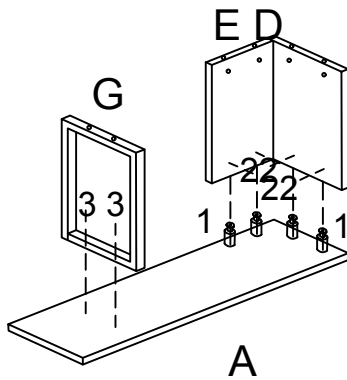

## Step:1

- |  |  |   |
|--|--|---|
| 1<br><br>×16pcs | 2<br><br>×16pcs | 3 (M6*20)<br><br>×8pcs |
|--|--|---|



Install panel A, D and E through fitting 1 and 2 .  
Connect square tube G through fitting 3.

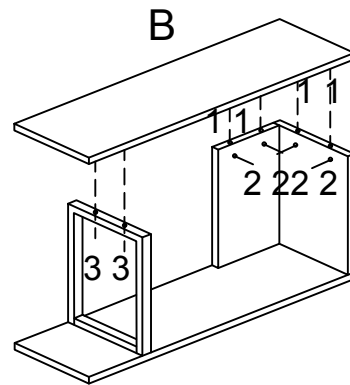

## Step:2

- |  |  |   |
|--|--|---|
| 1<br><br>×16pcs | 2<br><br>×16pcs | 3 (M6*20)<br><br>×8pcs |
|--|--|---|



Install panel B through fitting 1,2 and 3 .

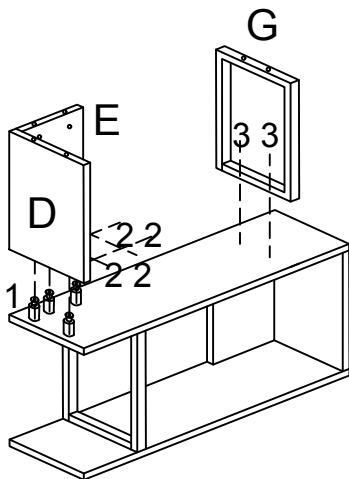

## Step:3

- |  |  |   |
|--|--|---|
| 1<br><br>×16pcs | 2<br><br>×16pcs | 3 (M6*20)<br><br>×8pcs |
|--|--|---|



Install panel D and E through fitting 1 and 2 .  
Connect square tube G through fitting 3.

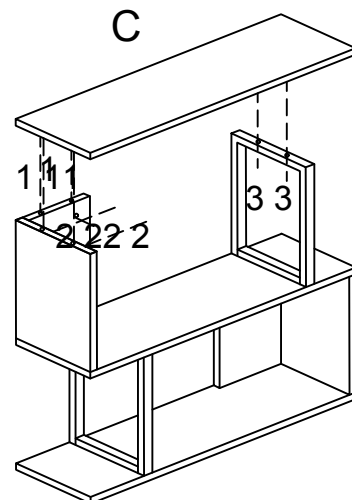

## Step:4

- |  |  |   |
|--|--|---|
| 1<br><br>×16pcs | 2<br><br>×16pcs | 3 (M6*20)<br><br>×8pcs |
|--|--|---|



Install panel C through fitting 1,2 and 3 .

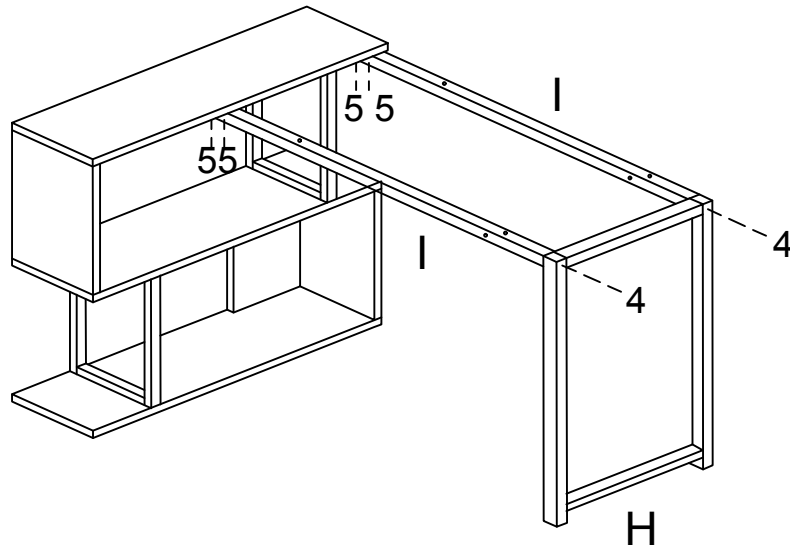

# Step:5

- |  |         |  |         |
|--|---------|--|---------|
| 4  | (M8*40) | 5  | (M6*35) |
|  |         |  |         |
| ×2pcs  |         | ×12pcs   |         |



Connect square tube H and I.



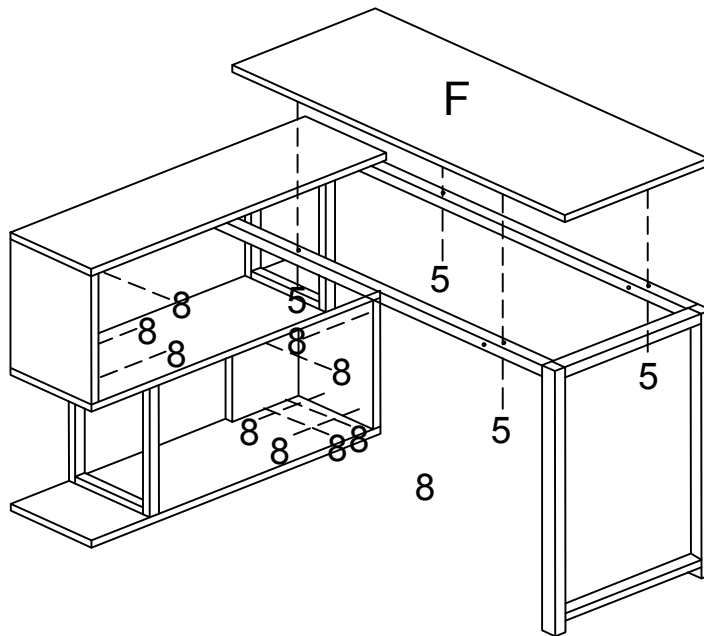

# Step:6

- |   |   |
|---|---|
| 5   | (M6*35)   |
|  |   |
| ×12pcs  |   |
| 8   |  |
| ×16pcs  |   |



Install plate F through accessory 5 and cover the mounting hole with accessory 8 .

# Step:7 Installation Complete !

- |   |   |
|---|---|
| 5   | (M6*35)   |
|  |   |
| ×12pcs  |   |
| 6   |  |
| ×4pcs   |   |
| 7   |  |
| ×4pcs   |   |
| 9   |  |
| ×2pcs   |   |

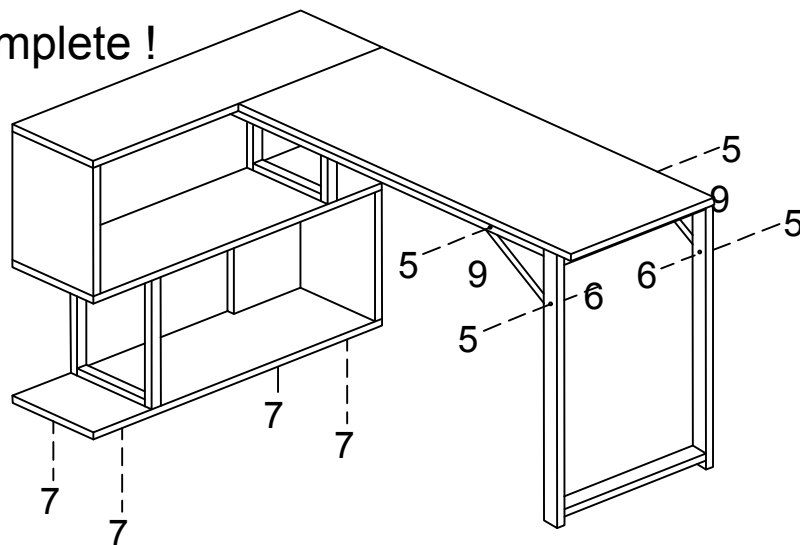

Install fitting 9 through fitting 5 and 6 . Install fitting 7 .