

Instruction Manual

80kg Quartered Parasol Base, Black Plastic

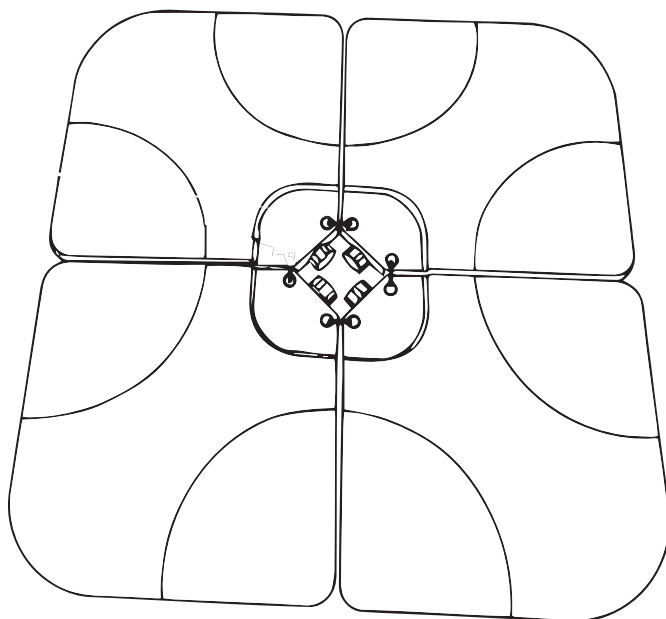

CONTENTS

Safety and care advice	1
Components	2
Assembly instructions	3
Copyright	6



⚠️ SAFETY AND CARE ADVICE ⚠️

PLEASE READ THESE INSTRUCTIONS CAREFULLY AND KEEP FOR FUTURE REFERENCE

- **Warning:** Please lift with care.
- Check you have all the components and tools listed on page 2.
- Remove all fittings from the plastic bags and separate them into their groups.
- Keep children and animals away from the work area, small parts could choke if swallowed.
- Make sure you have enough space to lay out the parts before starting.
- Do not stand or put weight on the product, this could cause damage.
- Assemble the item as close to its final position (in the same room) as possible.
- Assemble on a soft level surface to avoid damaging the unit or your floor (use opened out unit carton).



- We do not recommend the use of power drill/drivers for inserting screws, as this could damage the unit. Only use hand screwdrivers.
- Dispose of all packaging carefully and responsibly.

CARE AND MAINTENANCE

- Only clean using a damp cloth and mild detergent, do not use bleach or abrasive cleaners.

- From time to time check that there are no loose screws on this unit.

- This product should not be discarded with household waste. Take to your local authority waste disposal center.

Note *If required the next page can be cut out and used as reference throughout the assembly. Keep this page with these instructions for future reference.*

- We strongly recommend that you store your parasol when not in use, especially during winter months.

We do not recommend leaving your parasol out in poor weather or unattended in furniture when a gust of wind could cause damage.

You should ensure your parasol is clean and dry to prevent any mould or mildew forming when folded and stored.

COMPONENTS

Please check you have all the components listed below:



A x 4

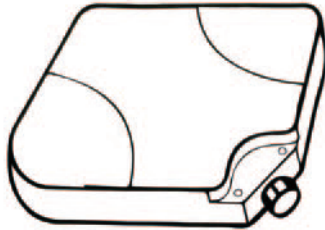

Water base

B x 4



Fastener



ASSEMBLY INSTRUCTIONS

Step 1

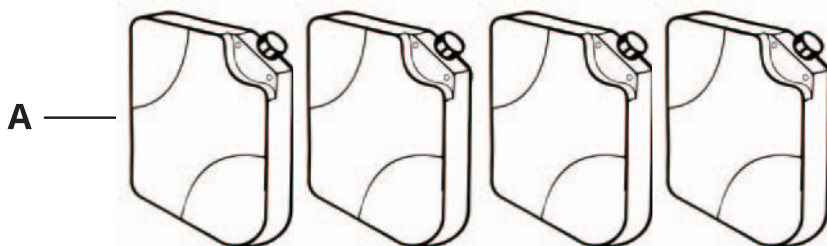
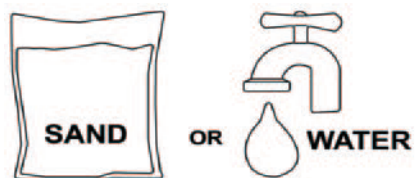

ASSEMBLY INSTRUCTIONS

Step 2

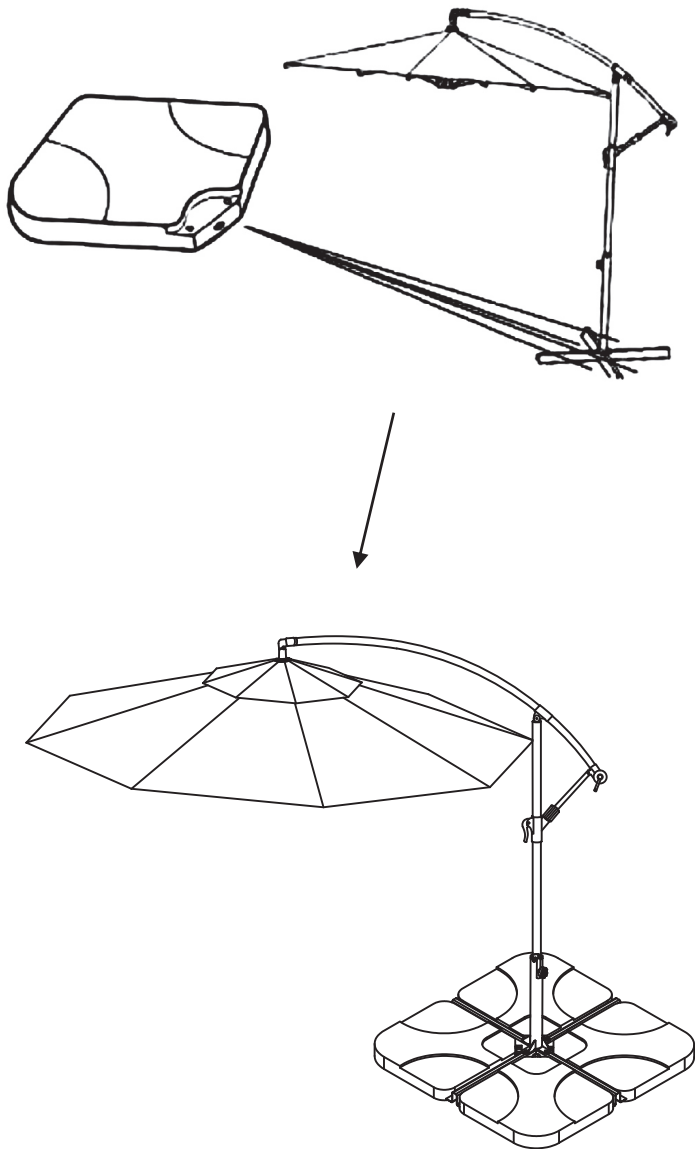

ASSEMBLY INSTRUCTIONS

Step 3

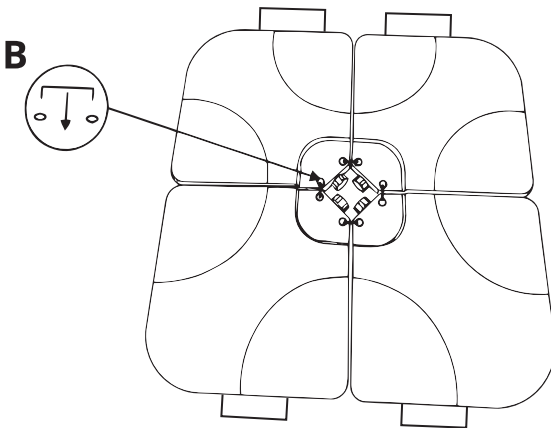
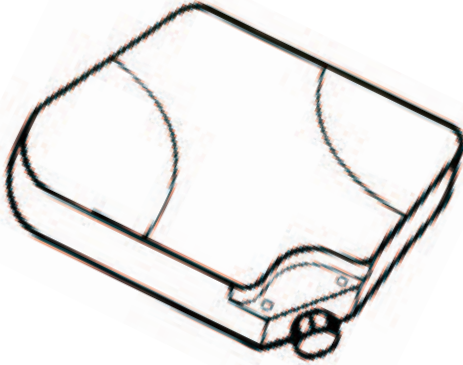

IF YOU FIND A DEFECTIVE PART

We fully stock all parts and components. Any defective part can be quickly replaced. Take note of the defective part number in manual and we will arrange a quick replacement.

COPYRIGHT

All material in this instruction manual is copyrighted

Any unauthorised use may violate worldwide copyright, trademark and other laws.