

Installation Instructions Recessed mount

1) Before installation, please measure the actual dimensions on both sides of the X/Y image on the left. The wall opening size should be larger than the actual measured product size.

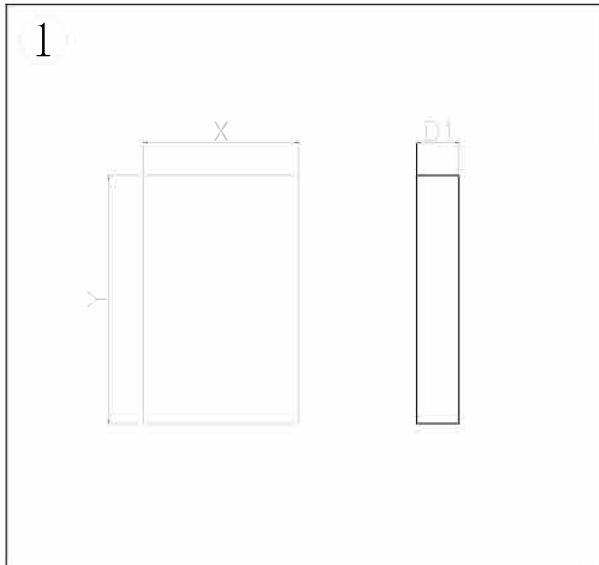

1) Install the product into the pre dug wall installation square hole.
2) Using a suitable screwdriver or drill, secure the cabinet into the wall with the supplied screws, via the two holes (two on each side) See Fig. below.

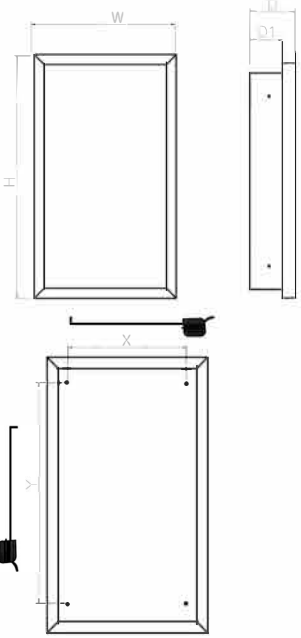
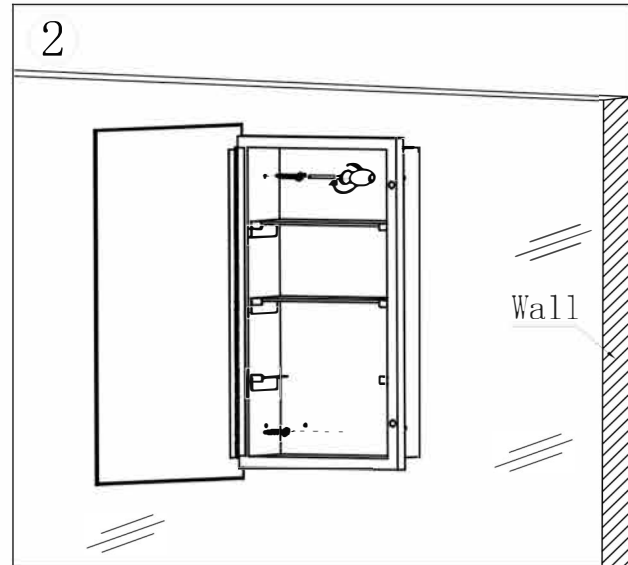

Surface Mount

1. Before installation, please place the product on the wall to the required position, and mark the installation hole position on the product chassis with pencil. Keep in mind that all marked mounting points to be matched up with the fixing points on the mirror accurately.

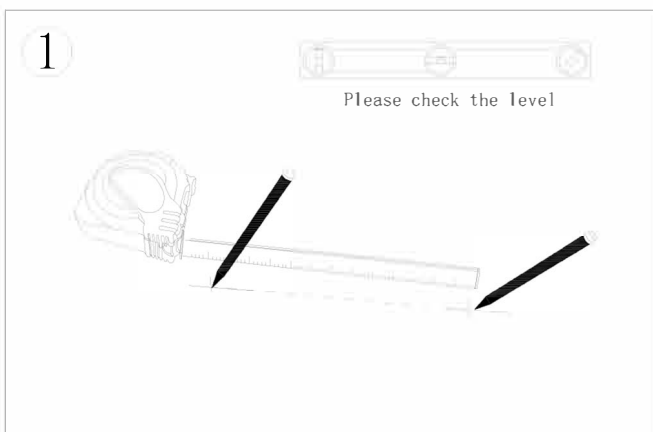

2. Mark the desired height and Width (X & Y) of the mirror. Drill the required holes.

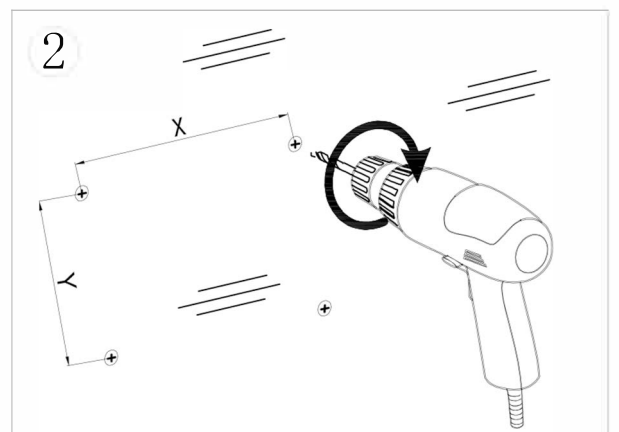

3. Insert the wall plugs.

Note: Wall plugs supplied are only suitable for solid stone/brick walls. Please ensure the screws are fully tight.

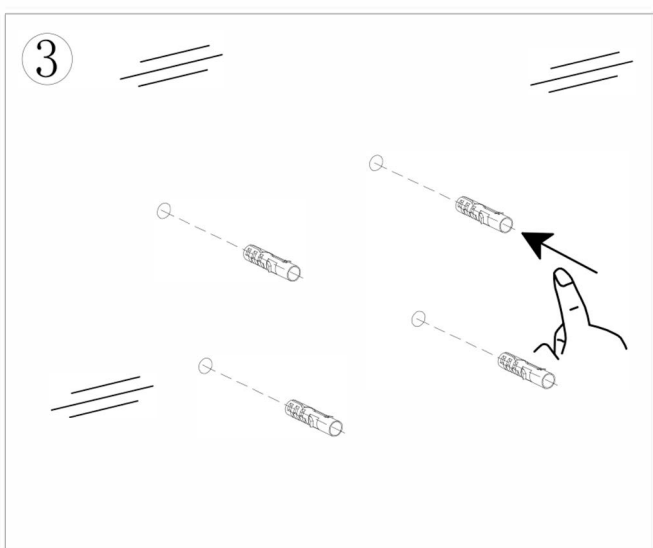

4. Hang the mirror onto the wall.

