

Features

- KOHLER finishes resist corrosion and tarnish.
- Conceals drain in console table installations.
- Combines with KOHLER console tables.
- 1-5/8" (41 mm) x 4-7/8" (124 mm)

Material

- Solid brass construction.

Components

Additional included component/s: Installation hardware.



Codes/Standards







None Applicable

KOHLER® One-Year Limited Warranty

See website for detailed warranty information.

Available Color/Finishes

Color tiles intended for reference only.

Color	Code	Description
	CP	Polished Chrome
	SN	Vibrant® Polished Nickel
	PB	Vibrant® Polished Brass
	BN	Vibrant® Brushed Nickel
	BV	Vibrant® Brushed Bronze
	2BZ	Oil-Rubbed Bronze
	TT	Vibrant Titanium

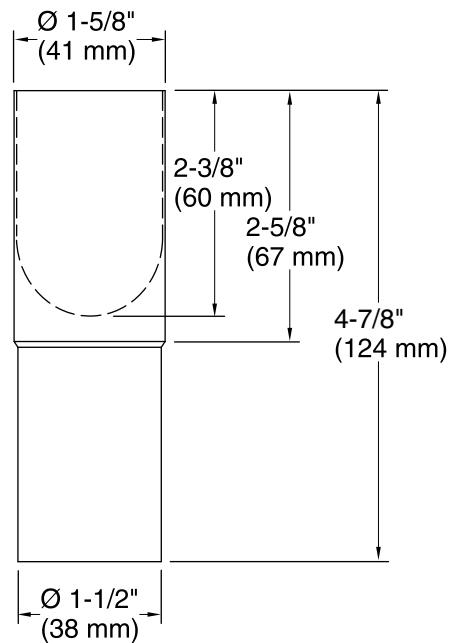

Technical Information

All product dimensions are nominal.

Notes

Install this product according to the installation guide.