

Assembly Instructions

Caution : You must read this before you proceed

Club Chair

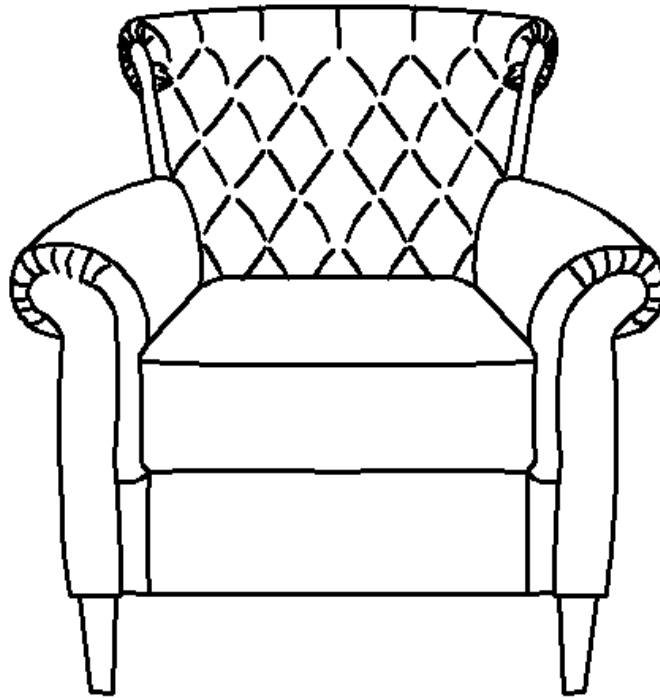

Parts List

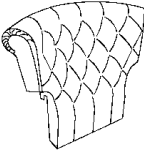
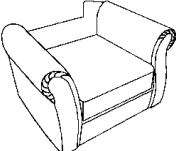
Label	Picture	Description	QTY
A		Chair Back	1
B		Chair Base	1

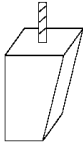
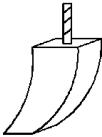



C		Front Leg	2
D		Back Leg	2

Hardware

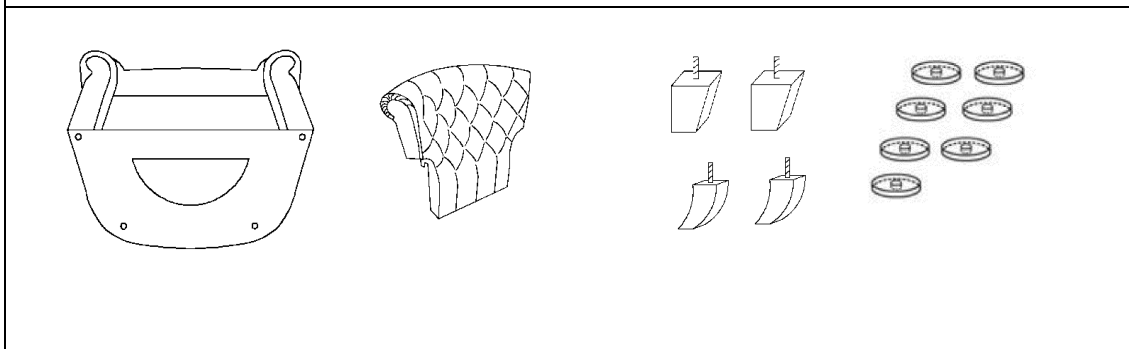
Label	Picture	Description	QTY
①		Gasket	7

Assembly Preparation



-  • Read instructions, cover to cover-
-  • Have 2 adults on hand for assembly-
-  • Do not assemble on flooring or carpet-
-  • Assemble on a clean non-marring surface (packing foam)-
-  • Save all packaging until finished-

Assembly Steps

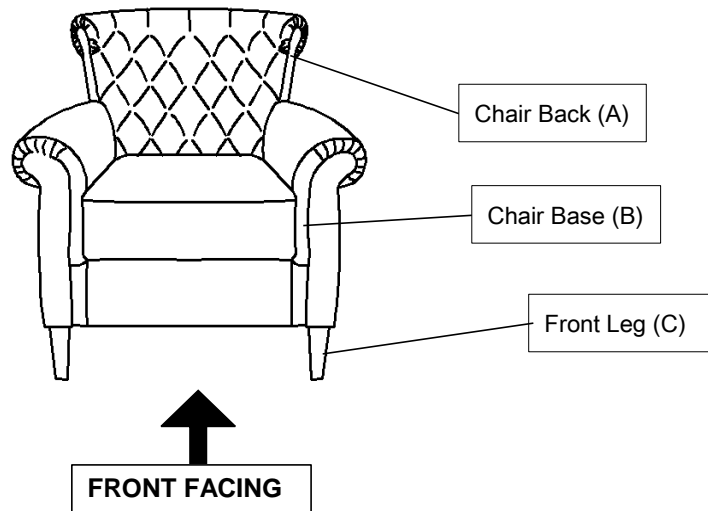

This Club Chair has multiple parts and may require up to 30 minutes to assemble. To give you an overview of the Club Chair parts, the above picture is to help you put the various parts into perspective. Please read through the instructions below to familiarise yourself with the parts and steps before assembly.

Step 1

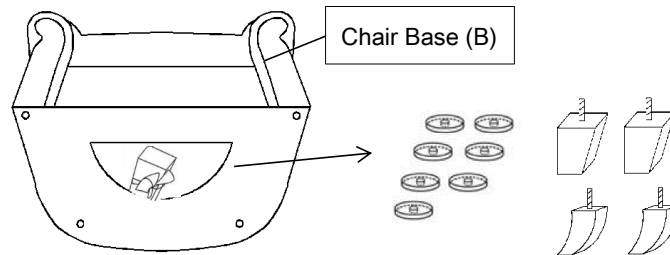

Place the Chair on its back on a clean, non-marring surface as pictured above.
Carefully unzip the pouch at the bottom of the Chair Base(B) and remove the Front Leg(C), Back Leg(D) and Hardware.
Close the pouch.

Step 2

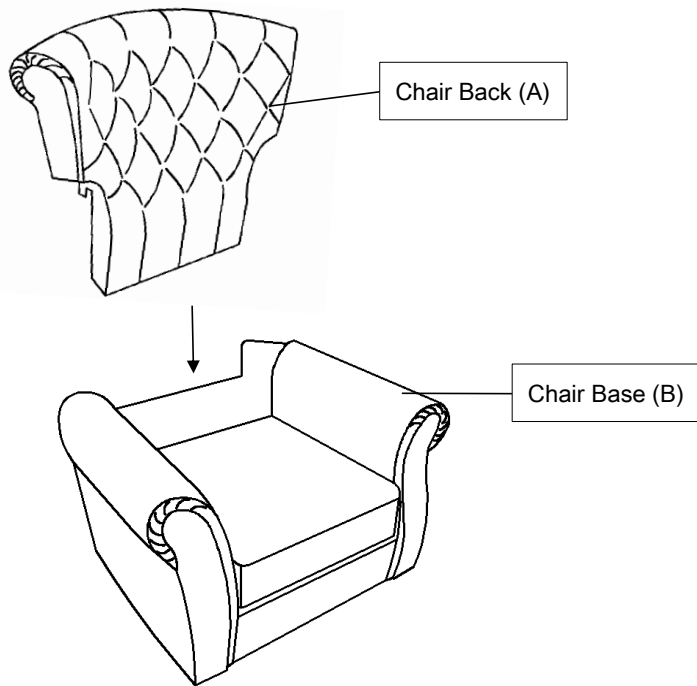

Position yourself behind the Chair and place the Chair Back(A) into the Chair Base(B). Tilt the Chair Back slightly forward, then gently pull the Chair Back towards you while pushing it down all the way into the Chair Base.

Step 3

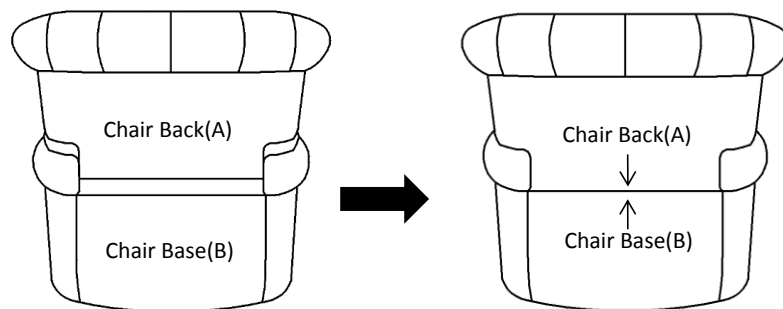

If you find a gap between the Chair Back(A) and Chair Base(B), please push rock the Chair Back(A) back and forth slightly, while pressing the Chair Back downwards until the gap disappears.

Step 4

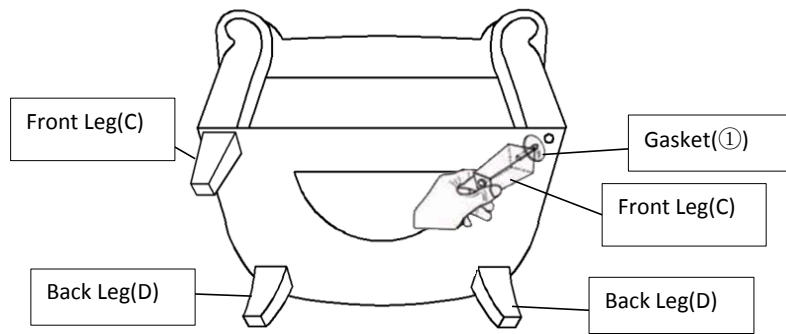

Install Front Leg(C) into the Chair Base(B) by putting a Gasket(①) on the threaded stem. Then insert the threaded stem into the mounting position at the corner of the bottom of Chair Base(B).

Tighten by turning the Front Leg(C) clockwise by hand.

Repeat the same process to install the remaining Front Leg(C) and Back Leg(D).

The use of Gaskets are OPTIONAL and are especially useful to help alleviate slight wobbles.



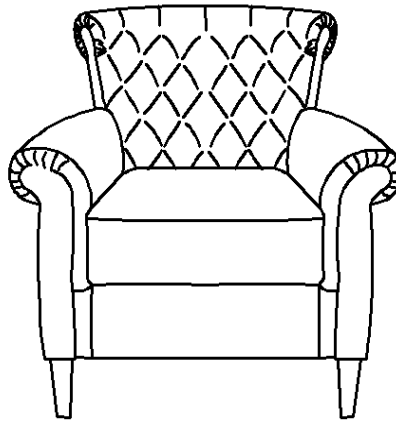







Step 5



Your Club Chair is ready for use.

This Club Chair can only be used on a flat, level surface.

Care & Maintenance

-  ● Do not put hot items directly on furniture surface
 -  ● Do not clean furniture with harsh cleansers or polish.
 -  ● Do not place furniture under direct sunlight.
 -  ● Do not place furniture near heating or cooling vents.
 -  ● Do not write on furniture without a padded barrier to protect the surface.
 -  ● Do not place furniture outside . For indoor use only .
 -  ● Not for commercial use. For residential use only .
 -  ● Stains may be removed with mild soap solution and damp cloth.
 -  ● Children should not climb or jump on the furniture.
-
-  ● Dust and pick-up spills using a clean, non-colored, lint-free cloth .

What is Proposition 65?

Proposition 65 is a California law that requires warning labels on products that may contain one of more than 800-plus chemicals or ingredients that the California Office of Environmental Health Hazard Assessment (OEHHA) has deemed to cause cancer or other reproductive toxicity. Chemicals and elements on this list include wood dust, brass, and other everyday substances, which can be found in very common household items, such as: lamps, tableware, jewelry, crystal glasses, electric cords, beauty products, automobiles, and furniture.

Why Did I Find a Proposition 65 Warning on My Home Goods Product?

We include Proposition 65 warnings on all of our products because there is always a chance that one of the 800-plus common chemicals and ingredients listed under this law could potentially be on our furniture or packing materials. We risk large fines under this law, if we don't include this warning.

Should I worry?

We realize you may be worried finding this warning on our products, but we want to reassure you that the hazardous exposure limits for any of these chemicals have never been found on furniture products that we've shipped to our customers. Additionally, this warning label is very common and can be found on almost every piece of furniture sold in the state of California.

Just How Common Are Proposition 65 Warnings?

Proposition 65 warnings have become so common in California that it is hard to take a trip to a local bank, grocery store, or restaurant without finding at least one warning. In fact, even the Disney Land Resort has a Proposition 65 warning:

