

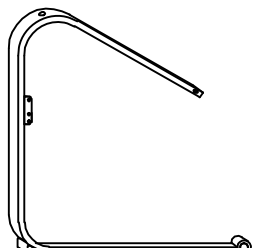









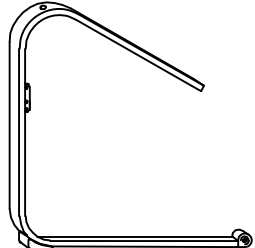

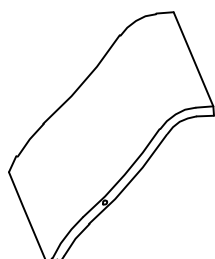

A	 X 1	H	 X 1
B	 X 1	I	M6*12  X 6
C	 X 1	J	M6*20  X 2
D	 X 1	K	M6*25  X 2
E	 X 1	L	M6*35  X 4
F	 X 1	M	M6  X 14
G	 X 1	N	M6  X 1

①

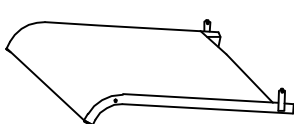

②

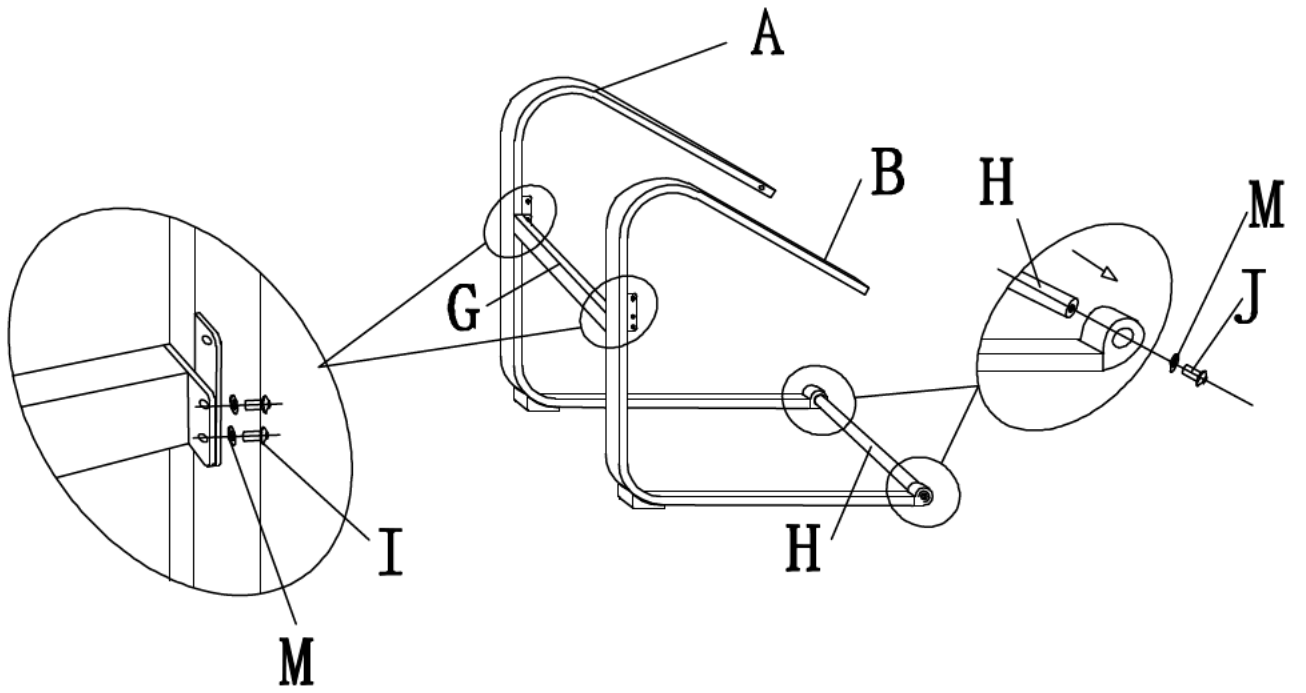
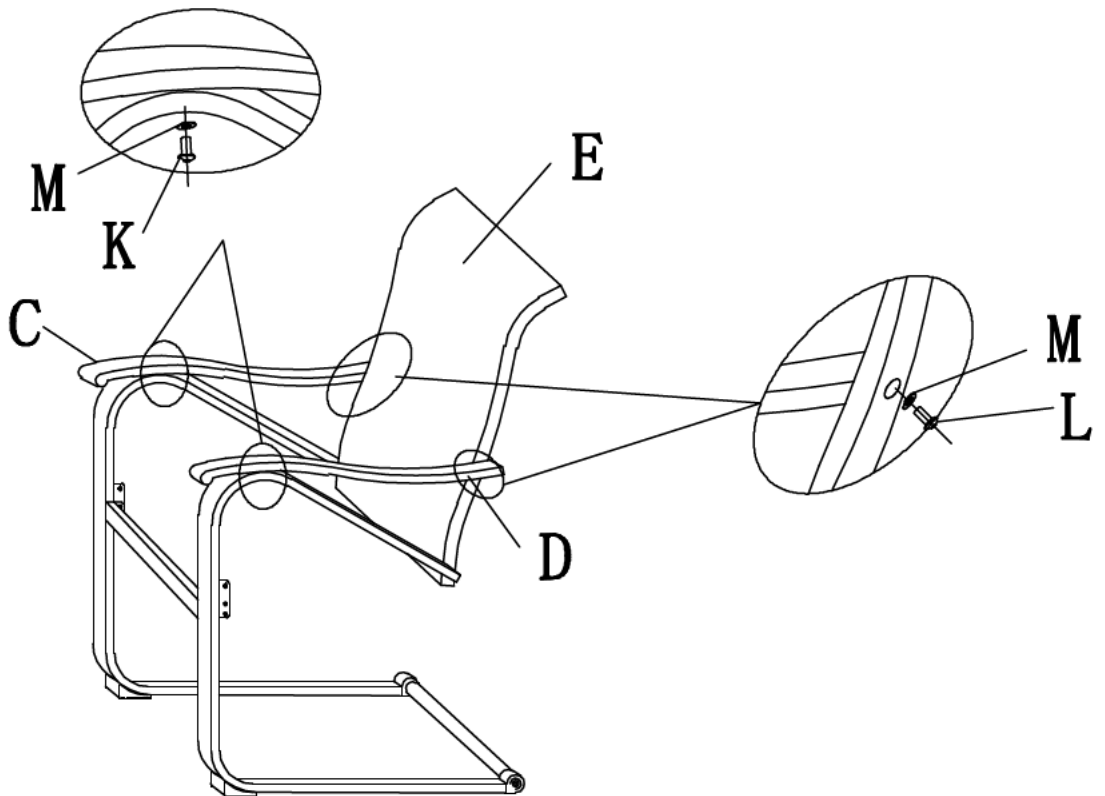

3

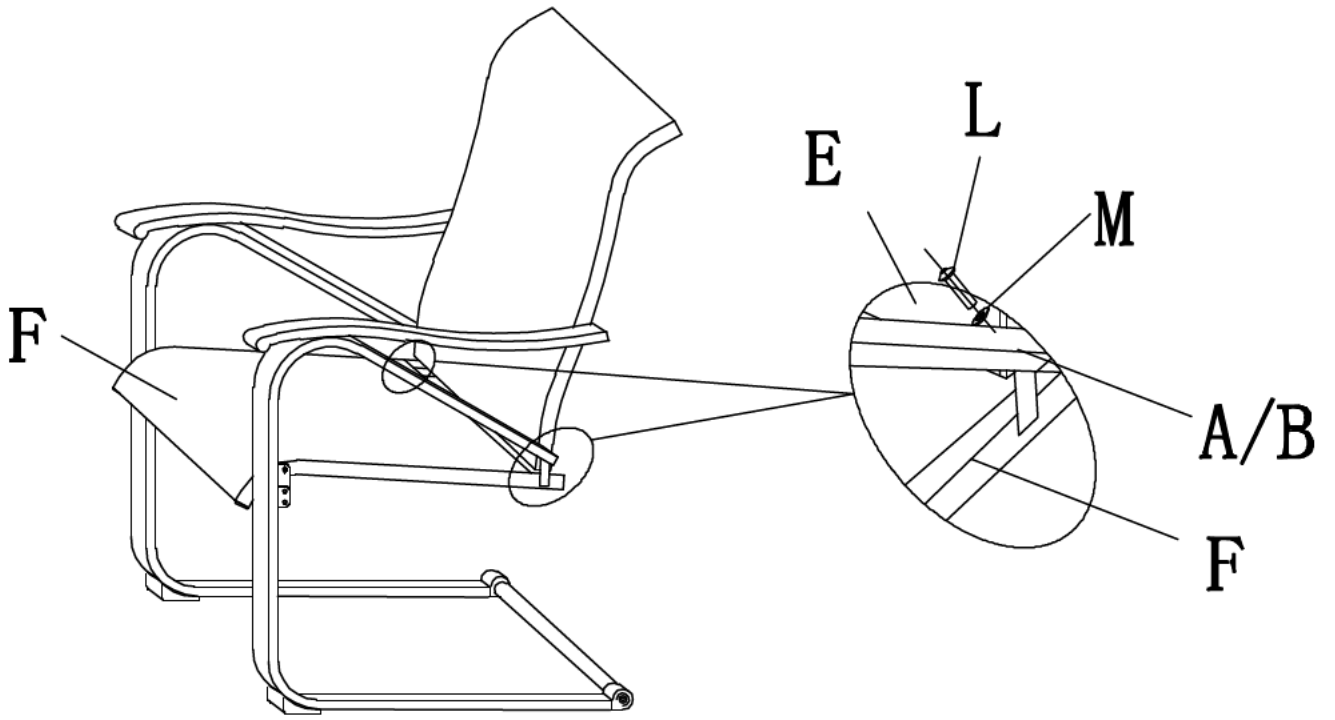

4

