

Assembly & Instruction Manual

SKU: A272 6x6ft

C arport assembly Installation Guide

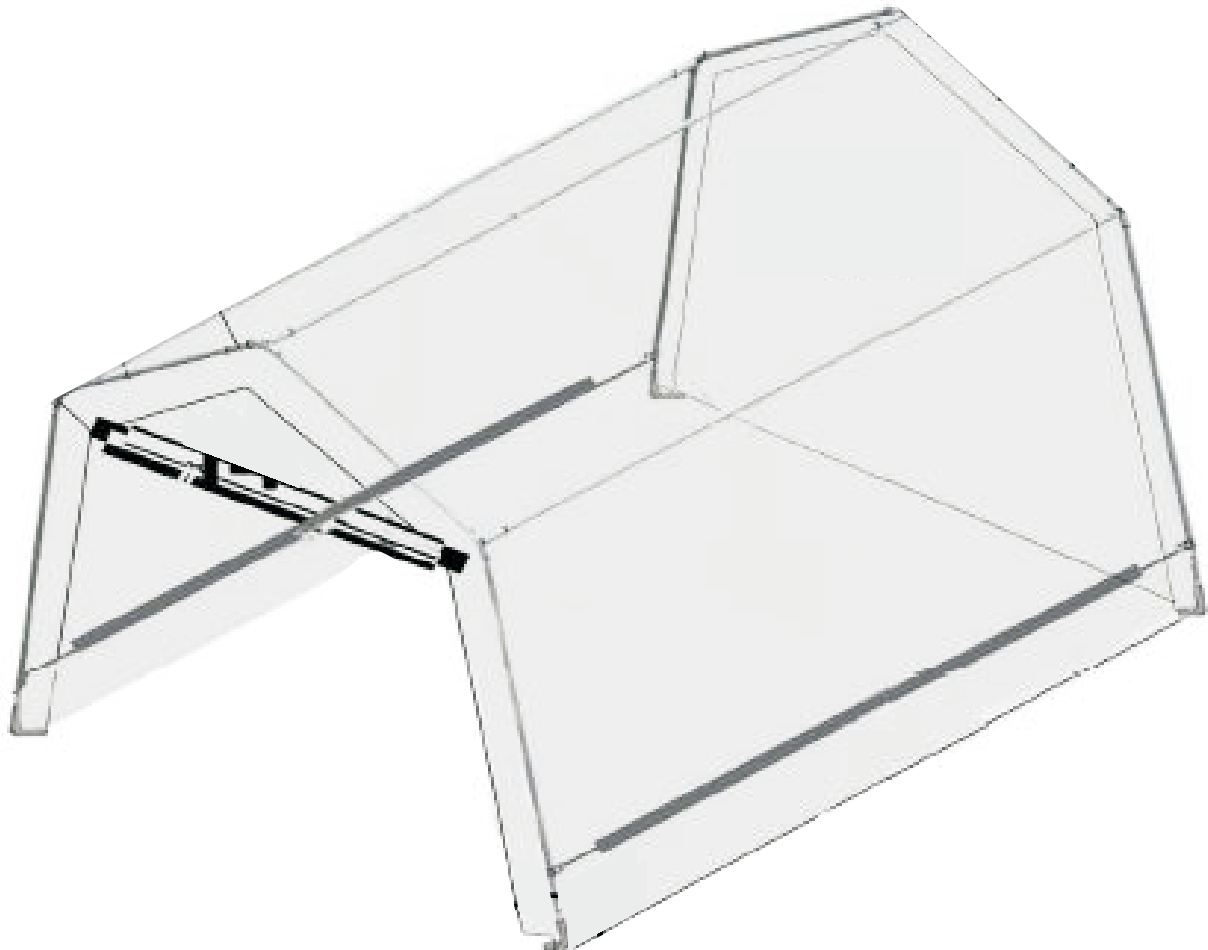

Version:20240222















Approximate
assembly time: **60 Minutes**

People
for assembly:

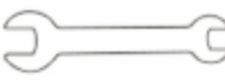

Save this manual for future reference

Parts Identification

Parts	Component	QTY	Ref No	Parts	Component	QTY	Ref No
①	 Roof tube	4	8A490-A272-001	②	 T-tube	3	8A490-A272-002
③	 Leg tube	4	8A490-A272-003	④	 Base tube	2	8A490-A272-004
⑥	 Base tube	4	8A490-A272-005	Ⓑ	 Three way connector	6	8A490-A272-006
Ⓓ	 Base part1	8	8A490-A272-007	Ⓕ	 Pegs	4	8A490-A272-008
Ⓘ	 Plastic marbles	28	8A490-A272-009	Ⓖ	 Tool	2	8A490-A272-010
Ⓗ	 Bolt M6x45mm	4	8A490-A272-011	⑫	 Rear cover	1	8A490-A272-012
⑭	 Door cover	1	8A490-A272-013	Ⓙ	 Roof cover	1	8A490-A272-014
Ⓚ	 Roof Fastener(winch system)	4	8A490-A272-015				

Assembly

- Remove all parts from box and dispose of all packaging correctly.
- Check that you have all the parts listed before starting.
- Assemble the shed on a flat level surface.
- We recommend that 2 people assemble this shed.
- Assemble it where you intend to place it.

1 Arches and Purlins Installation

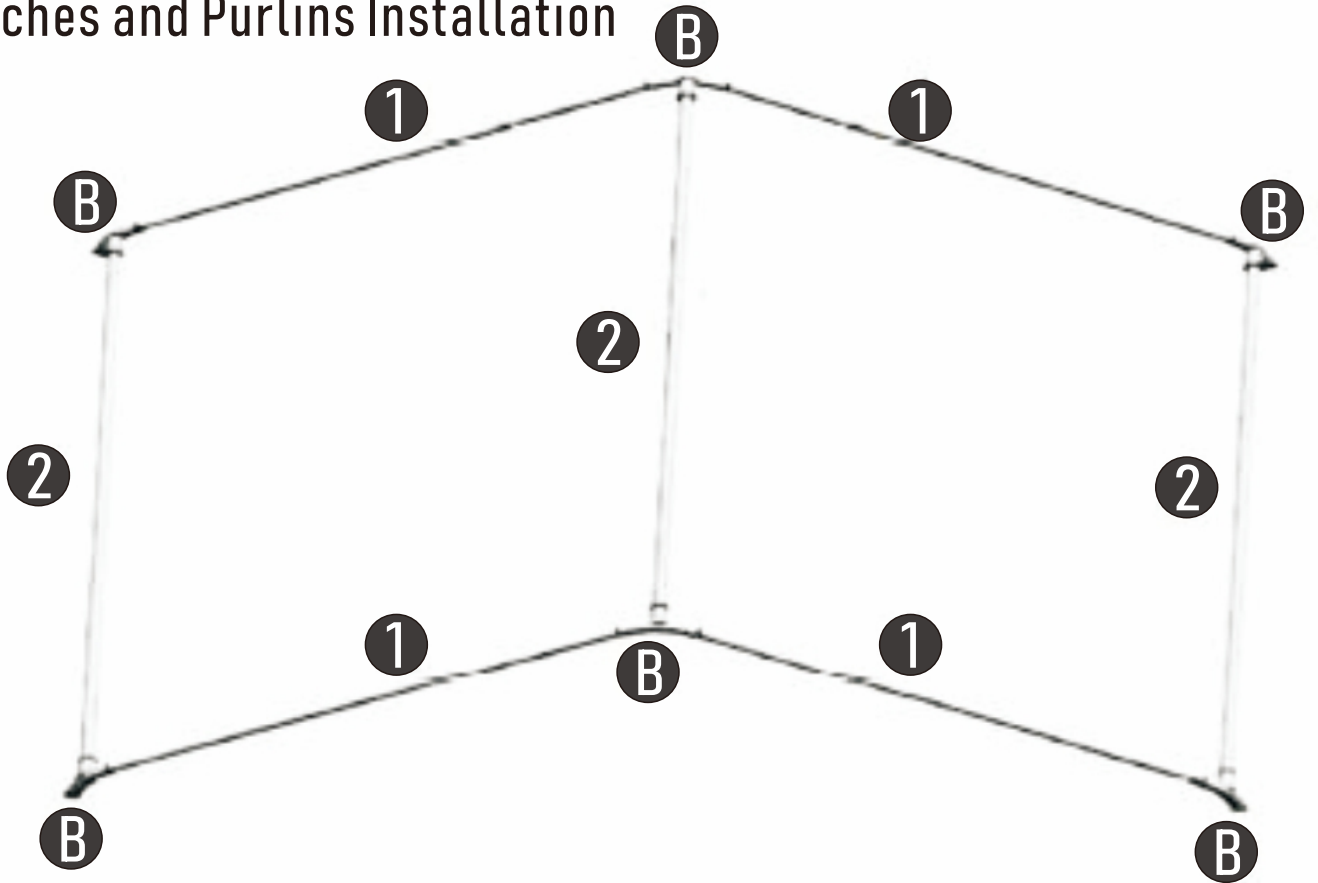

2

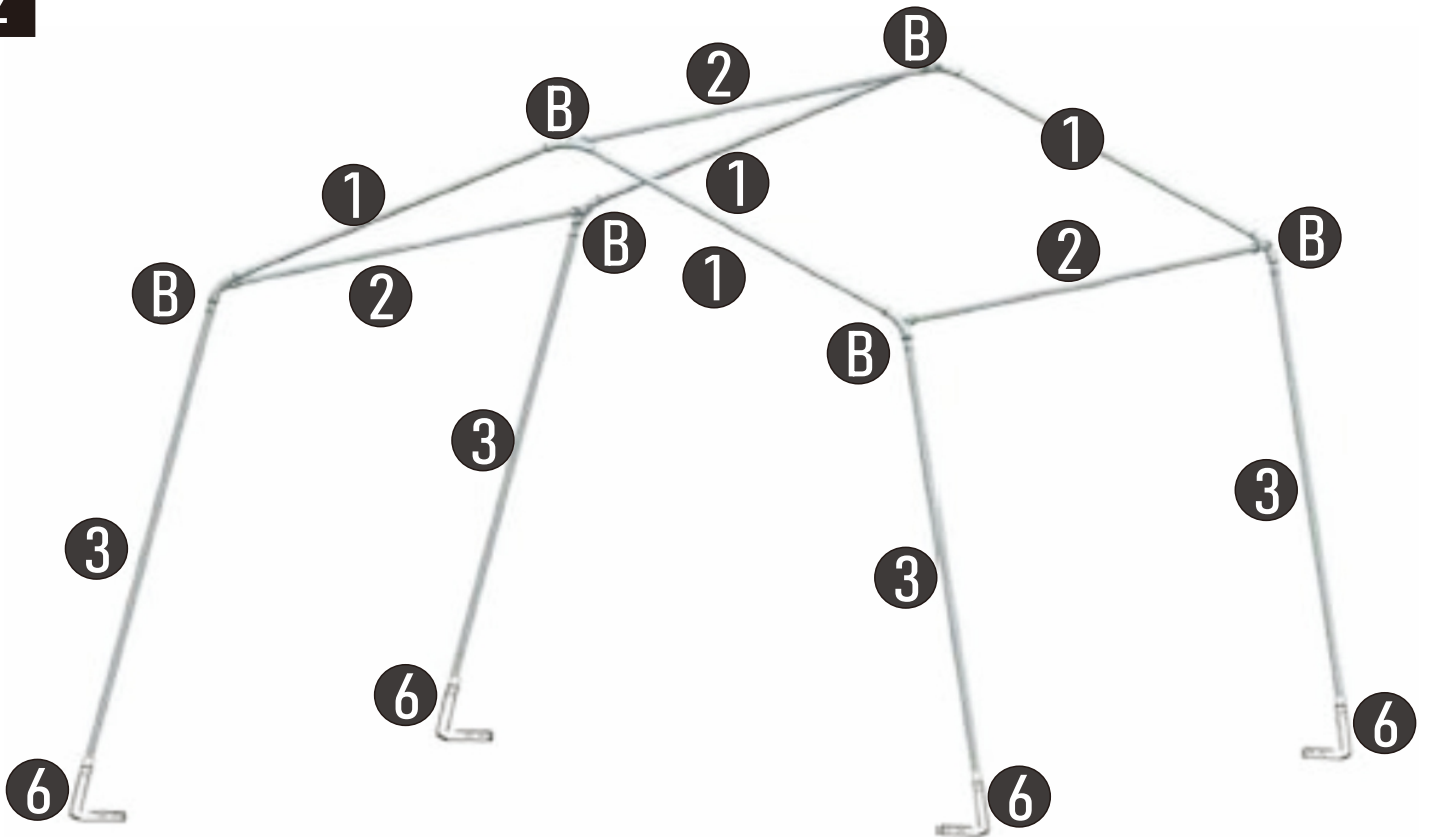

3

3

Attach the roof cover **J** onto the frame as shown, then insert tube **4** through the sleeve at the base of the cover. Connect both ends to parts **3**, with brace part **D** and bolt **H**, see Figure **A**.

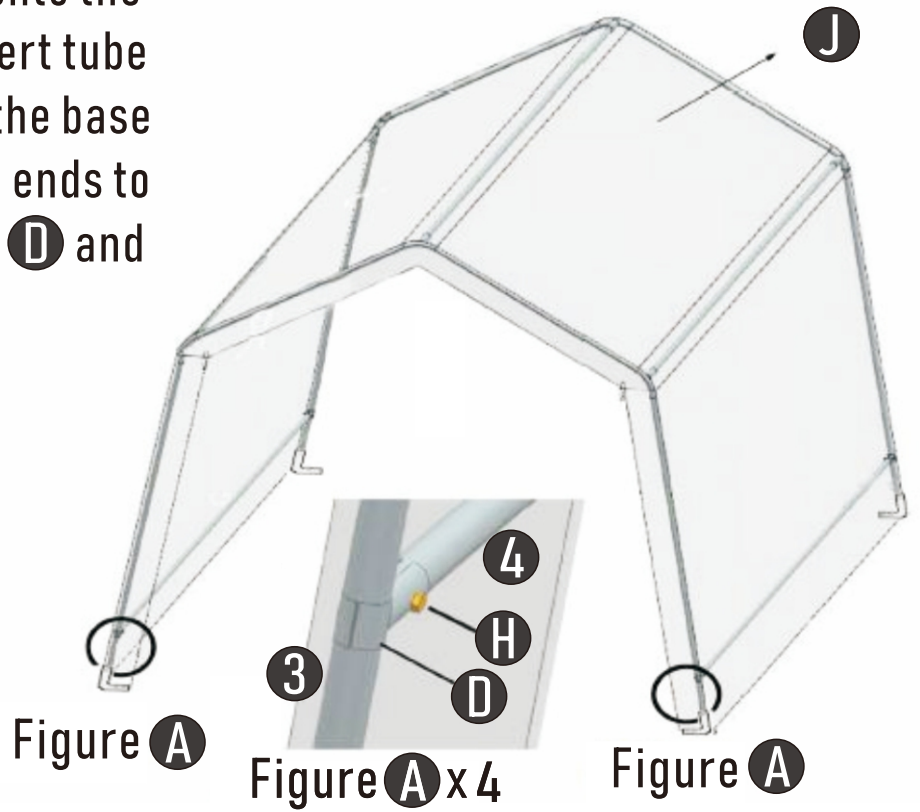

4

Fit rear cover, part **12** and door, part **14** using the plastic marbles. Connect and fit parts **6** base tube to each leg, part **3**. Secure with pegs **F**, see Figure **B**.

TOP TIP: Place the four bottom corners of the front and rear doors under the base tube to prevent it from moving:



Then secure the frame and cover by inserting the pegs to the holes on the base tubes, parts **6**.

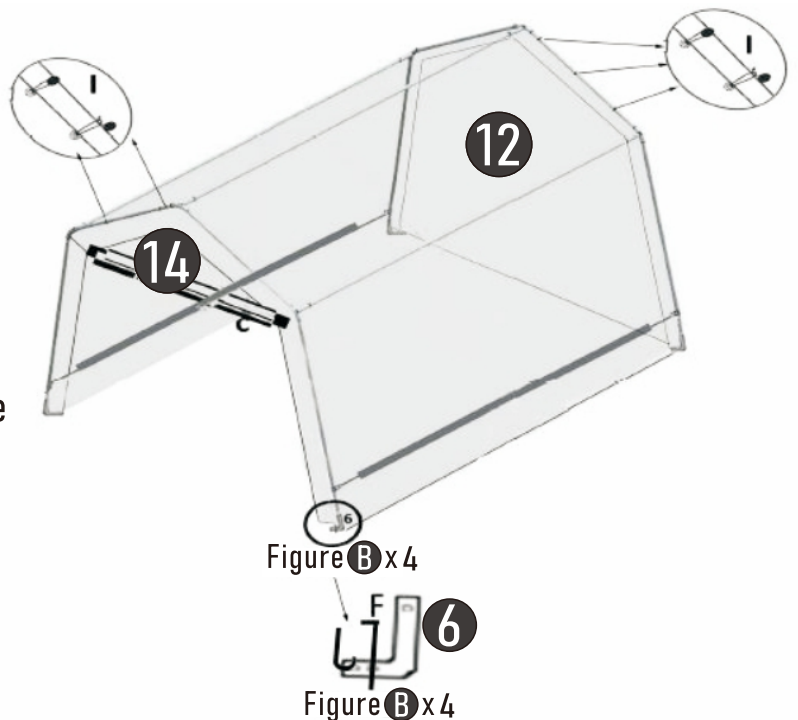

5.1

Assembling the roof fastener

1. Press **D** to open out the handle **B**, then insert the end of the roof rope through the central hole in the middle of the fastener, see **A** below, and adjust 'B' by moving back and forth.

Note: Do not pull the rope out of the cover completely

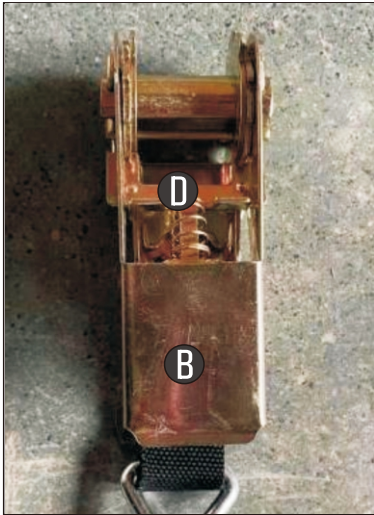

2. Before completely tightening, insert the hook in the hole at the end of the base tubes **6**, and continue tightening the roof fastener until you have the desired tension on the roof.

Note: To avoid splitting the cover and breaking the rope, do not overtighten the rope.

Ensure the load is split evenly over the rope and periodically check the cover is even at both ends of the shed as you are tightening the rope.



5.2

To loosen the fastener, open the handle **B** fully, by pressing **D**, so that it is in a straight line and press and hold position **C**, shown below; with the other hand, pull the end of the rope.

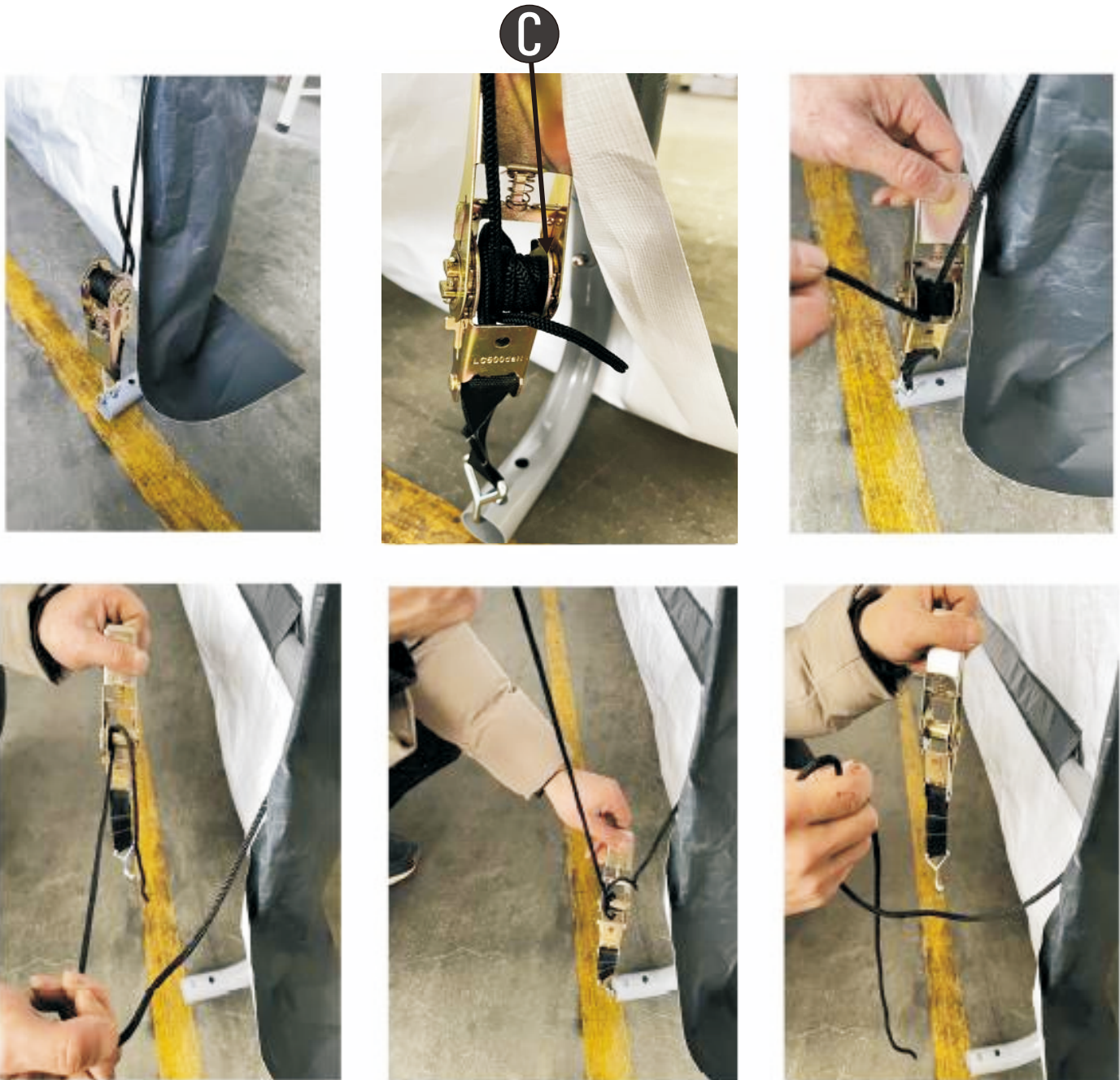

Please don't hesitate to contact us for any further questions,
your satisfaction is guaranteed.
support@aodorshop.com
<https://aodorshop.com/>