

ASSEMBLY INSTRUCTIONS

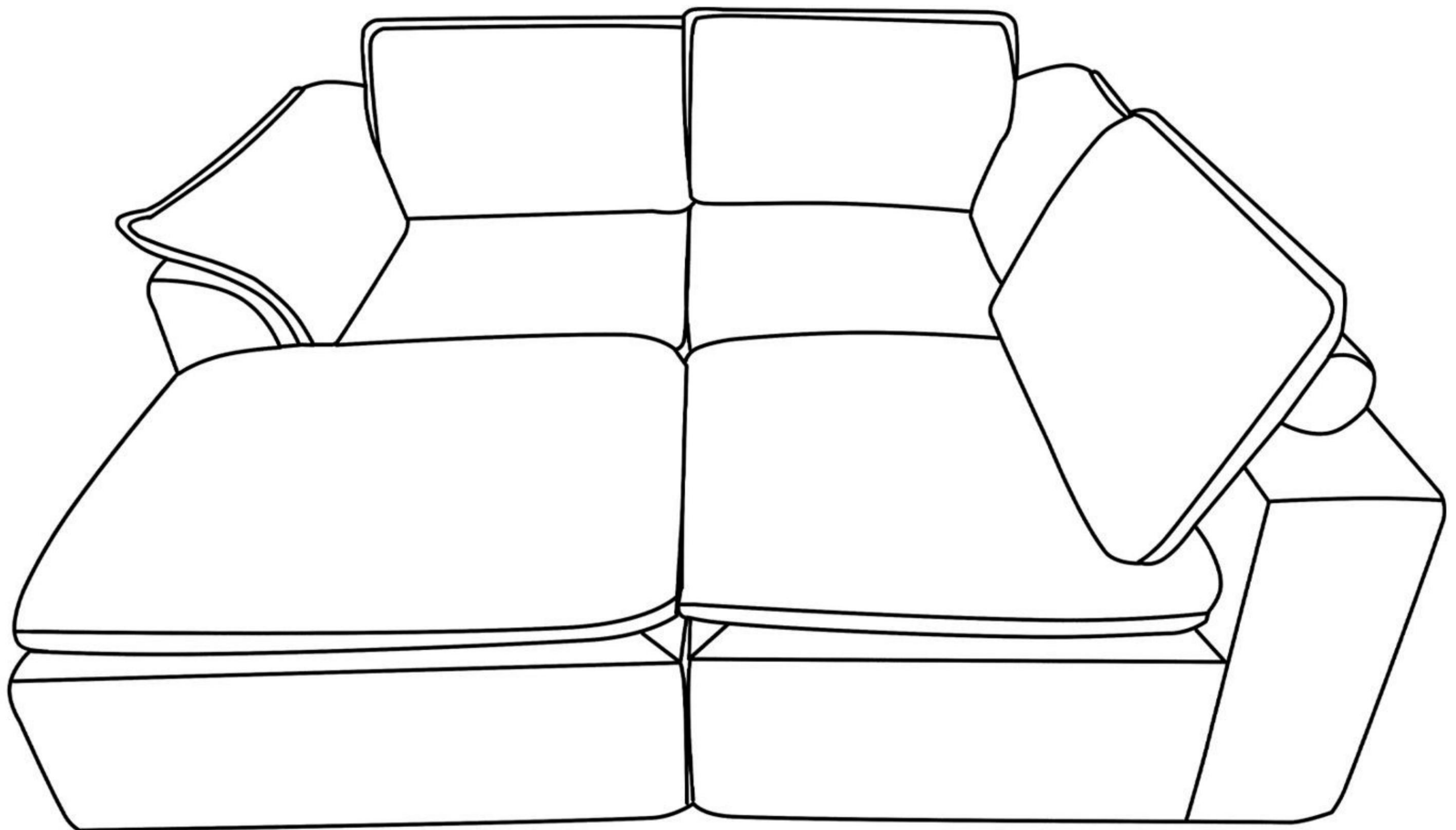

Instructions for using the sofa

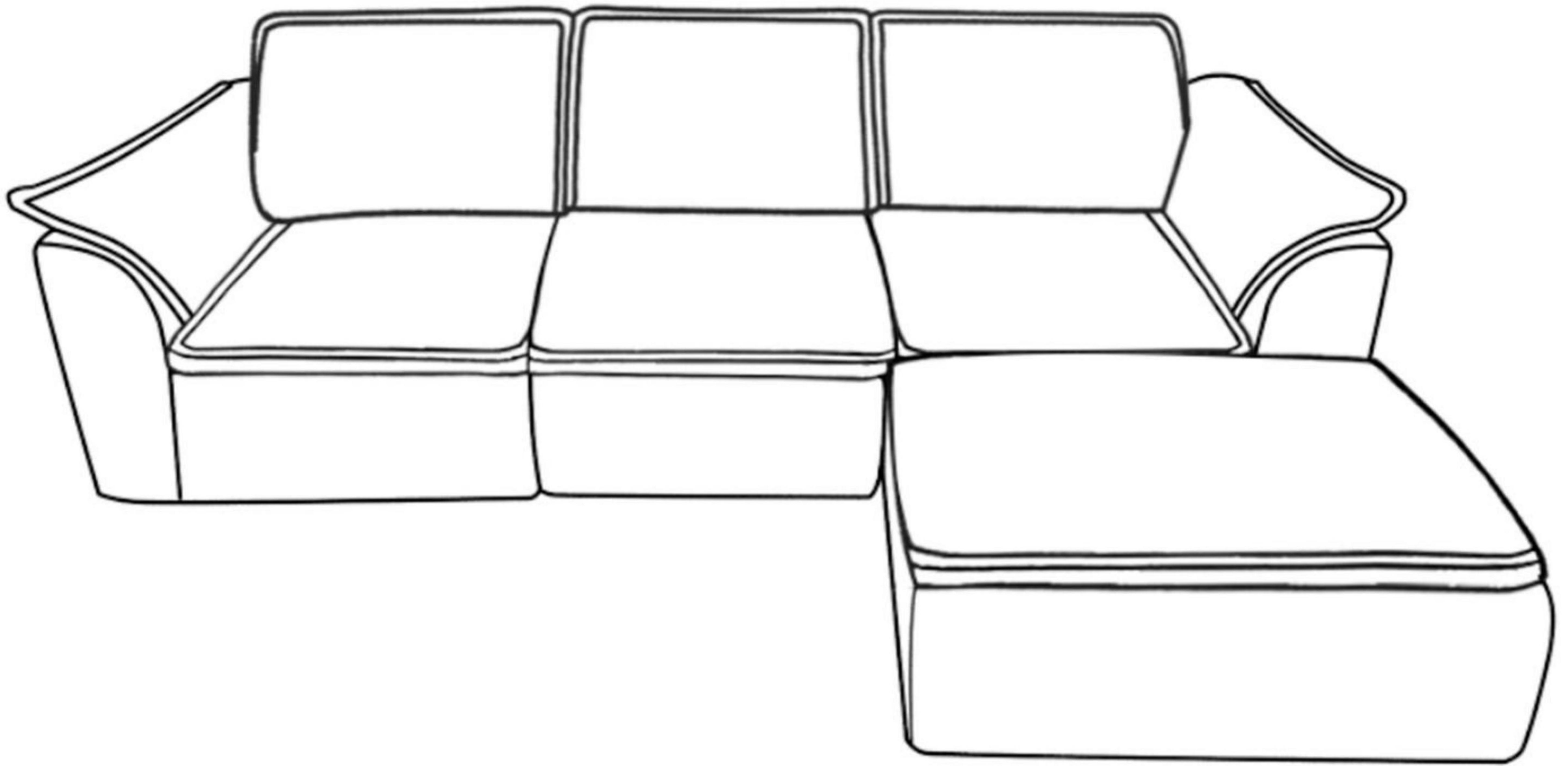
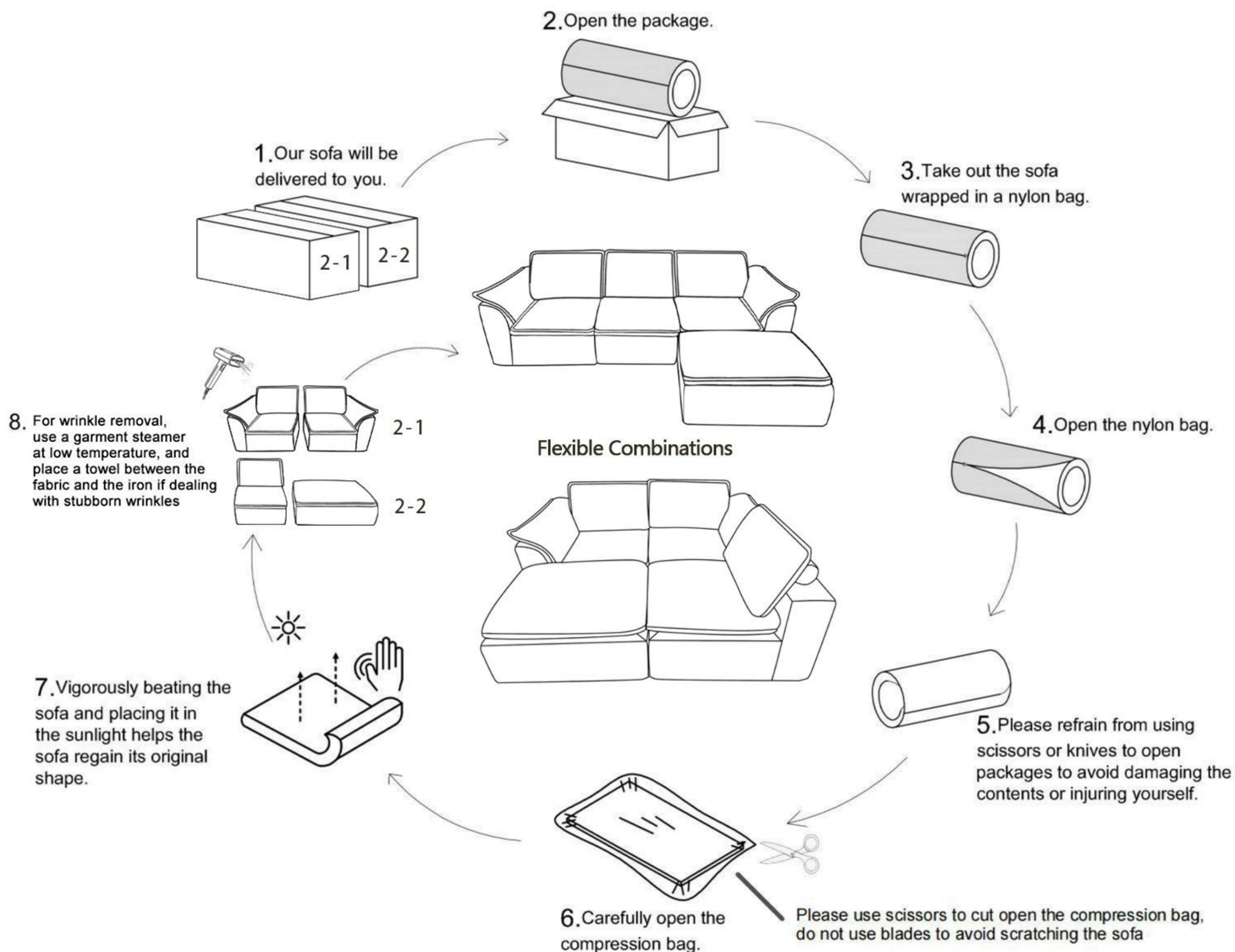

TIPS:

Our frameless foam and pocket spring sofa bodies are designed with industry-leading technology in luxury bedding. When opening the second layer of packaging, the sofa will expand and rebound to over 90% of its original shape after 72 hours. Minor wrinkles and bends are common and are not quality issues.

SOFA PARTS

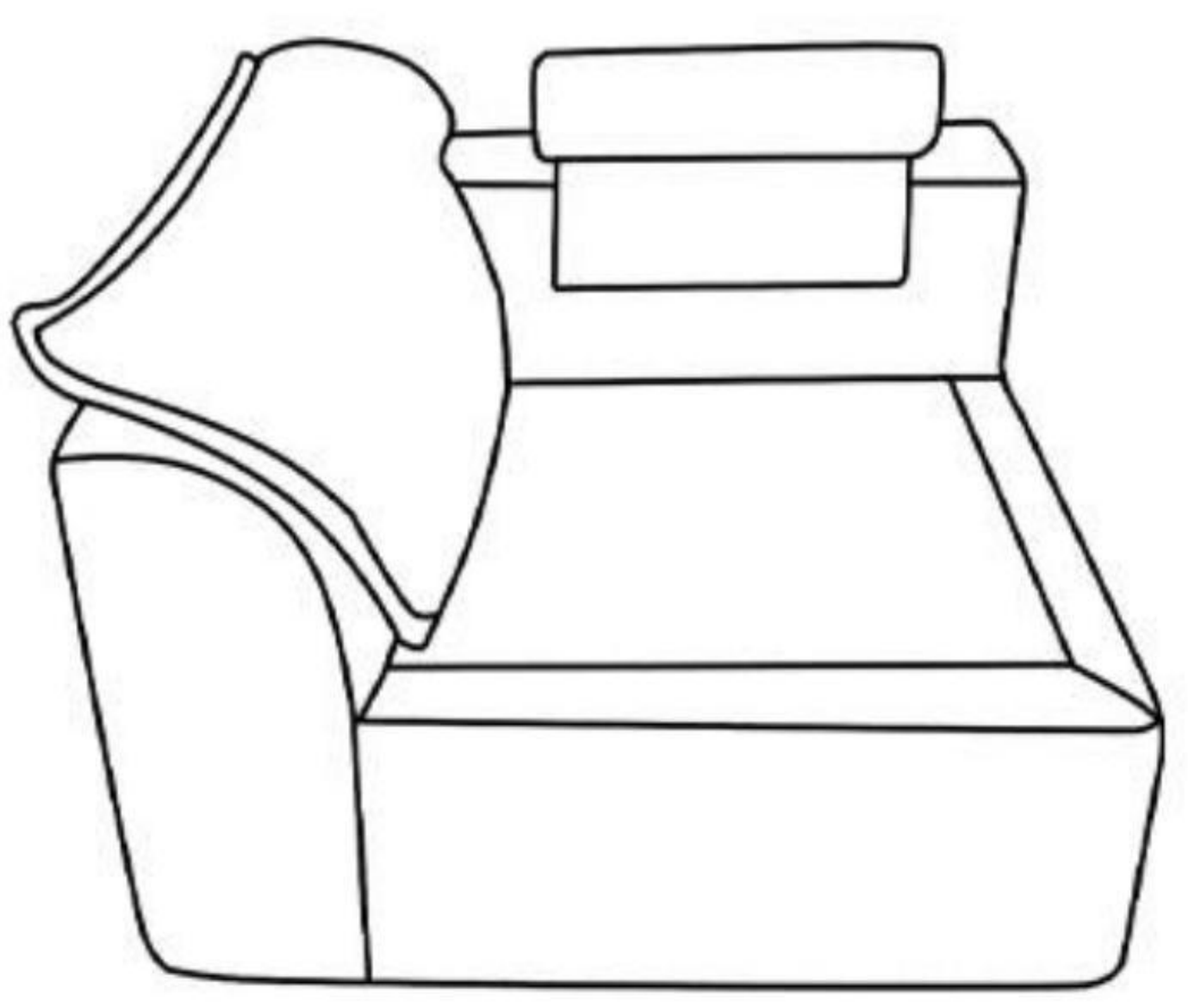

A LEFT SEAT
(CARTON 2-1)

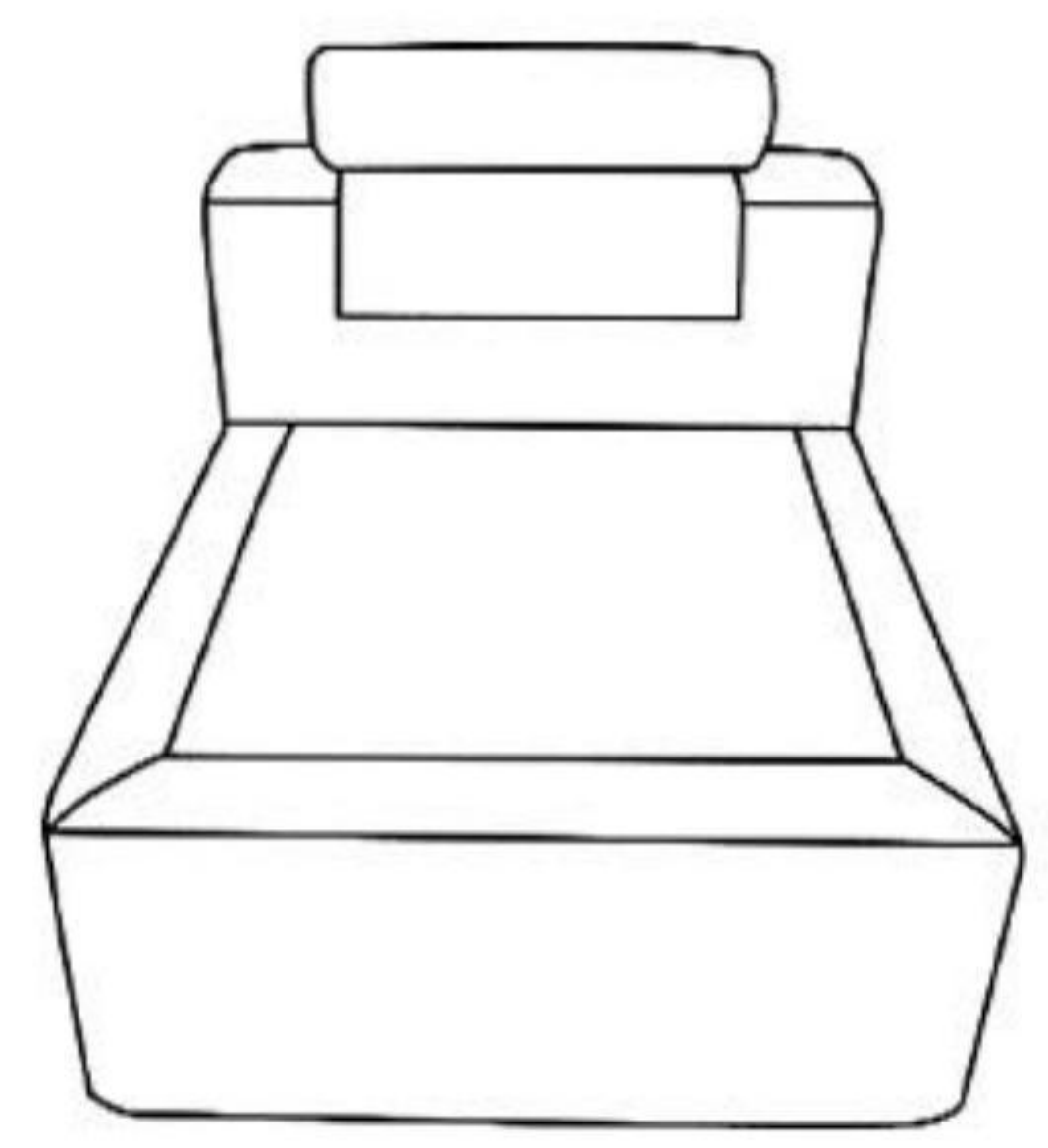

B MIDDLE SEAT
(CARTON 2-2)

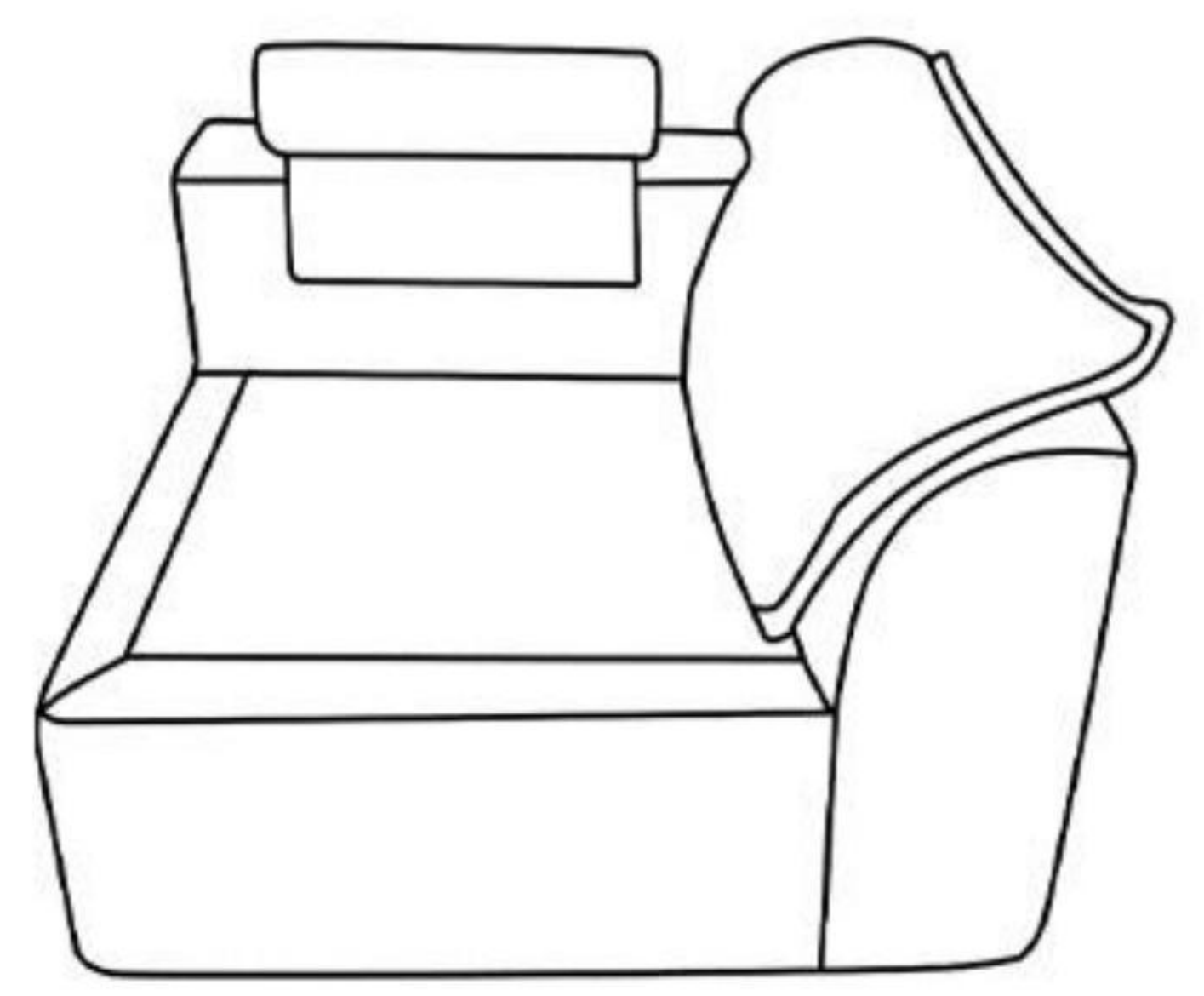

C RIGHT SEAT
(CARTON 2-1)

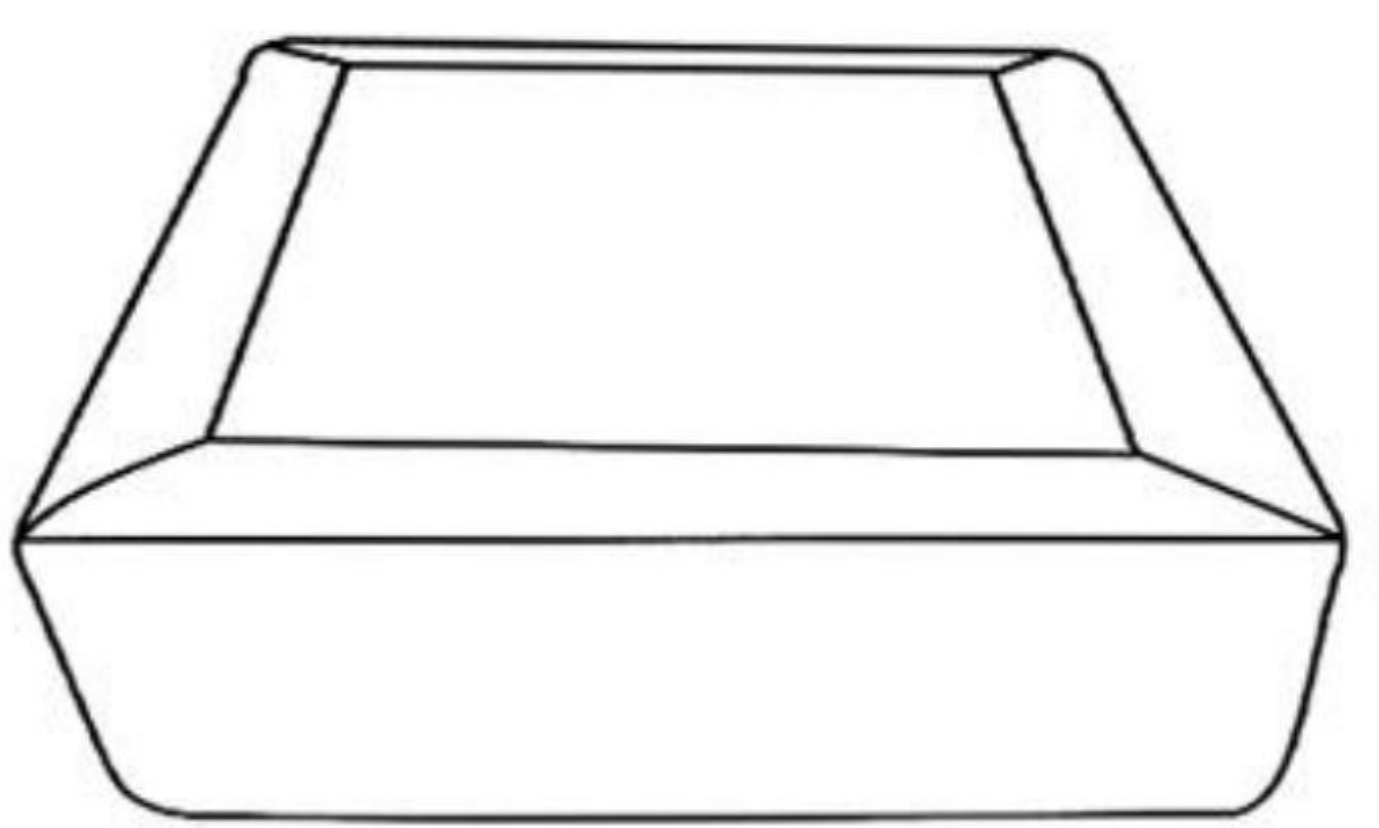

D OTTOMAN
(CARTON 2-2)

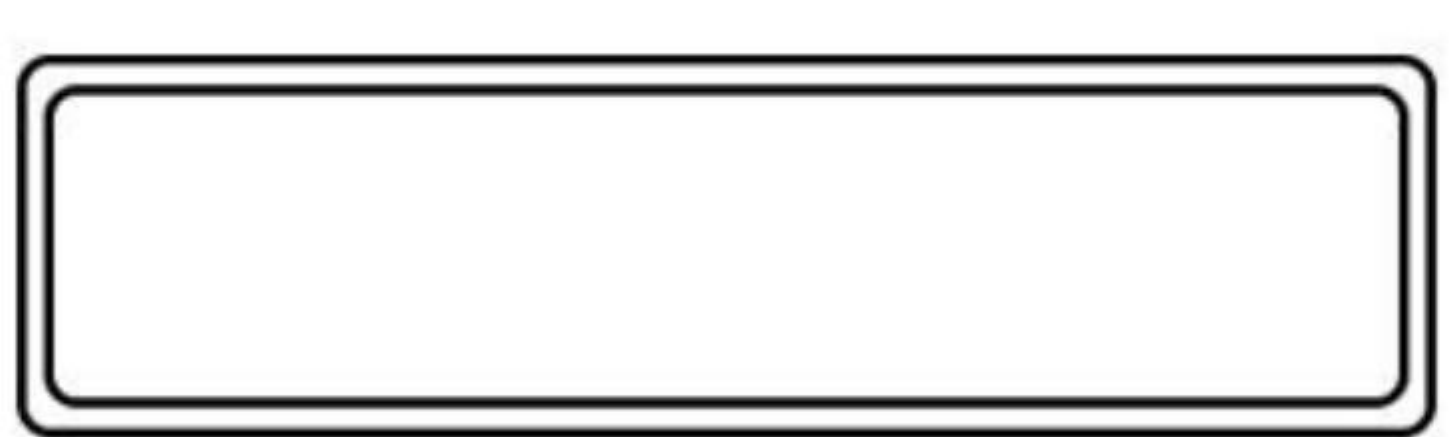

E VELCRO*6
(CARTON 2-1 *4)
(CARTON 2-2 *2)

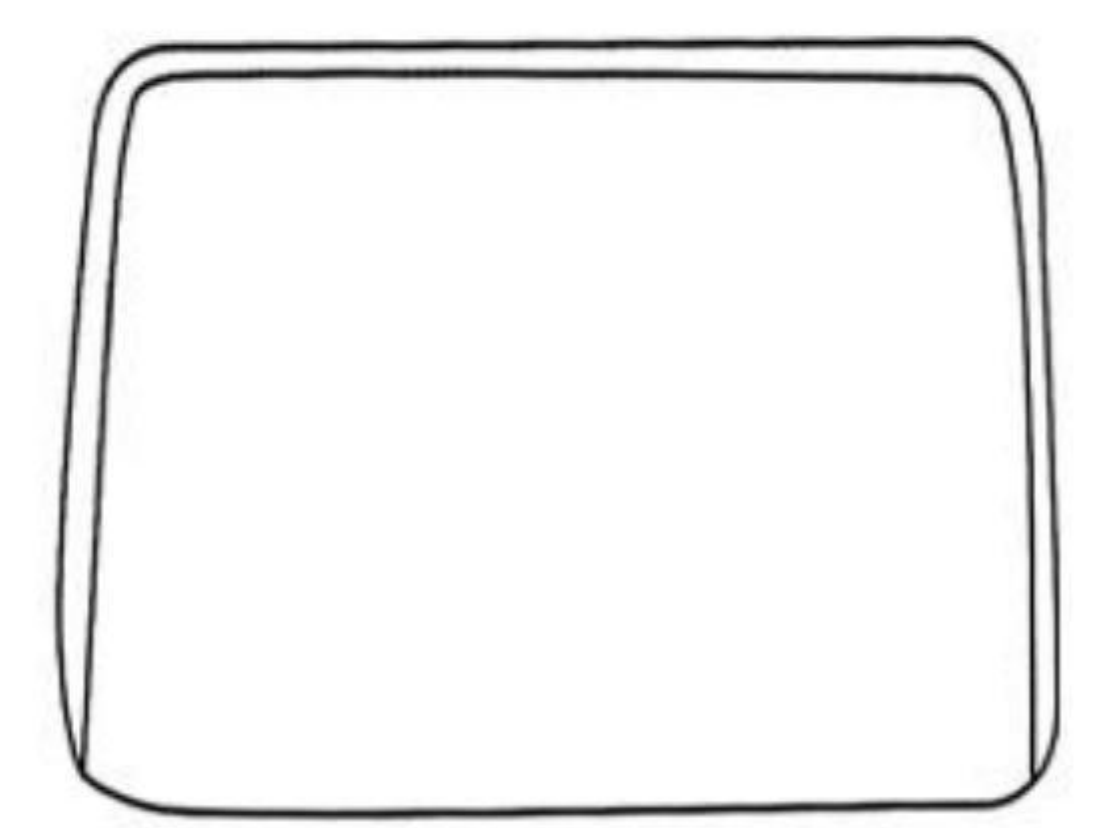

F SEAT CUSHION*4
(CARTON 2-1 *2)
(CARTON 2-2 *2)

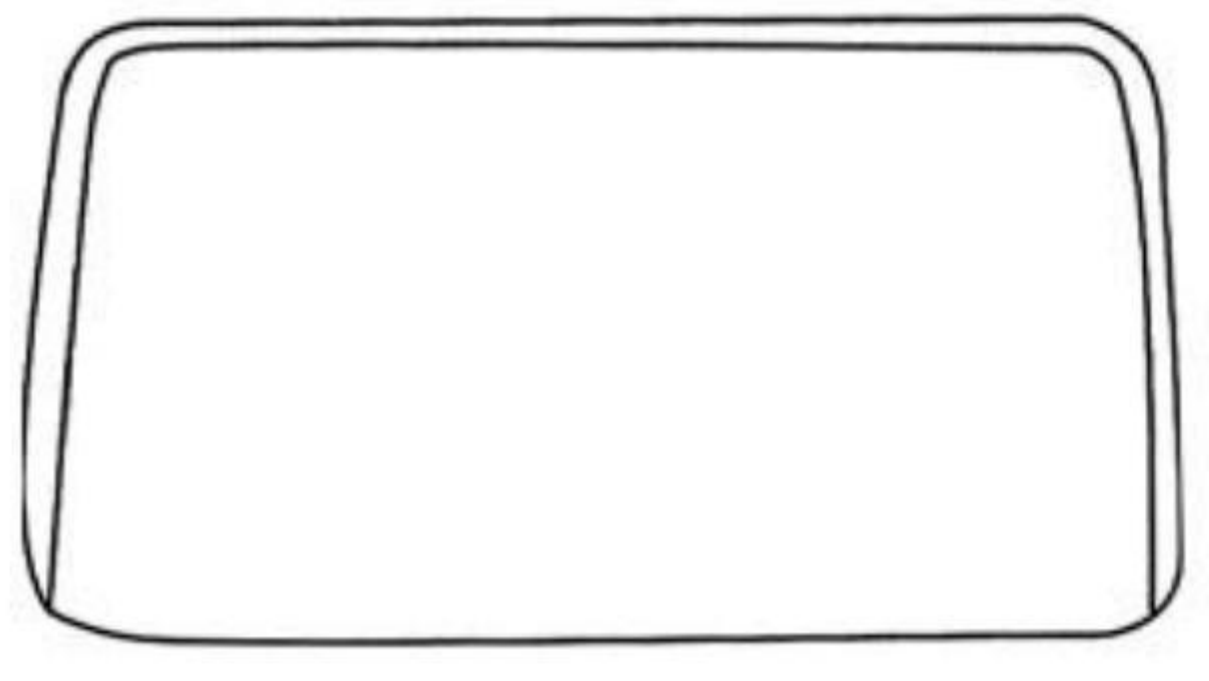

G BACK CUSHION*3
(CARTON 2-1 *2)
(CARTON 2-2 *1)

STEP 1

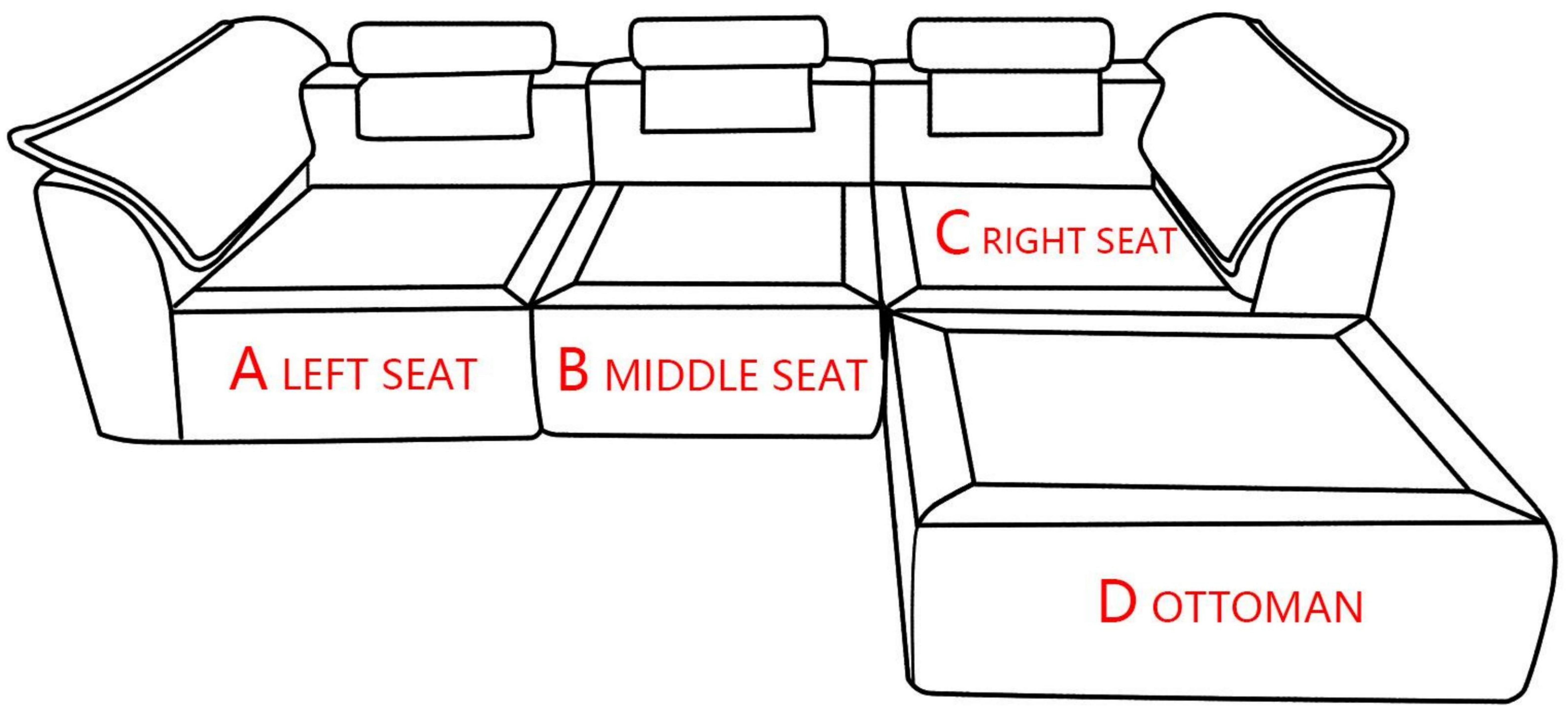

PUT 4 PIECES TOGETHER

STEP 2

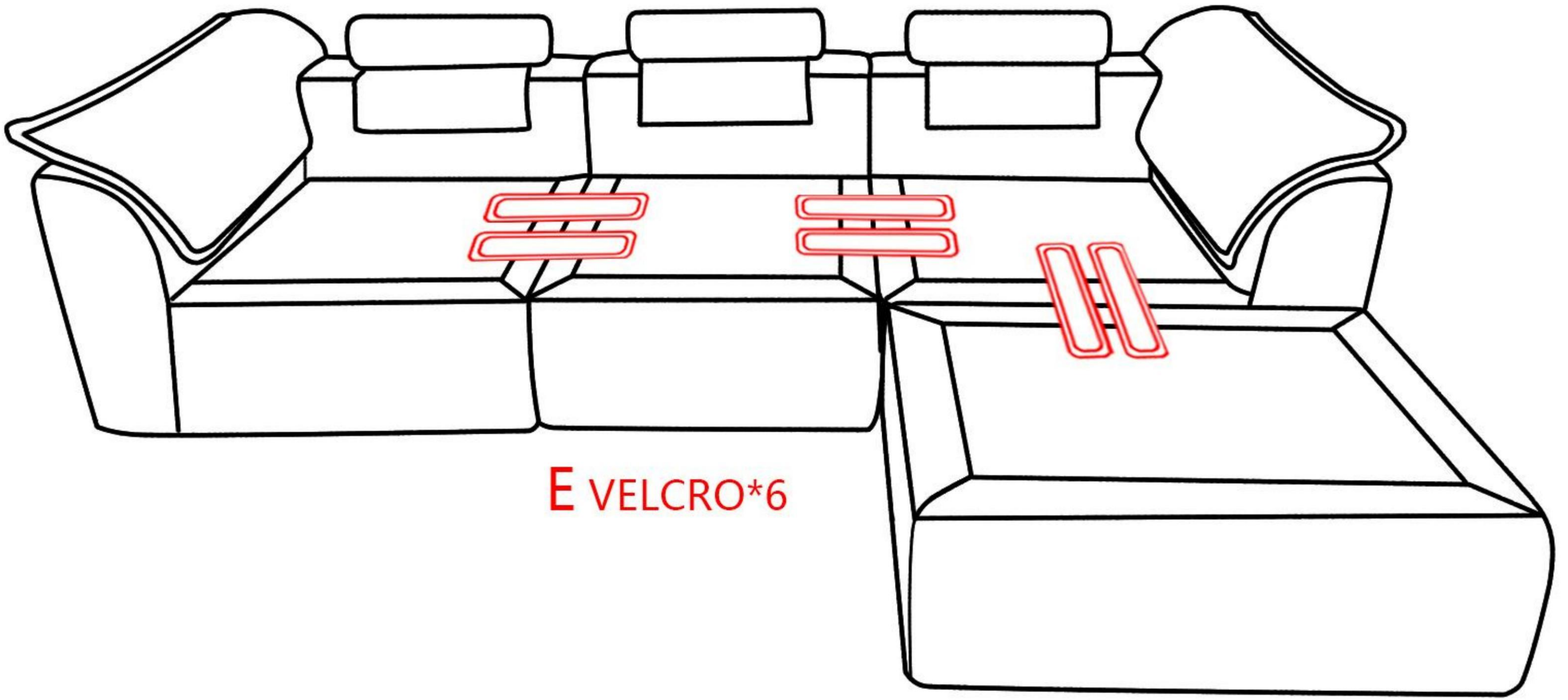

E VELCRO*6

FASTEN THE SEATS WITH VELCRO

STEP 3

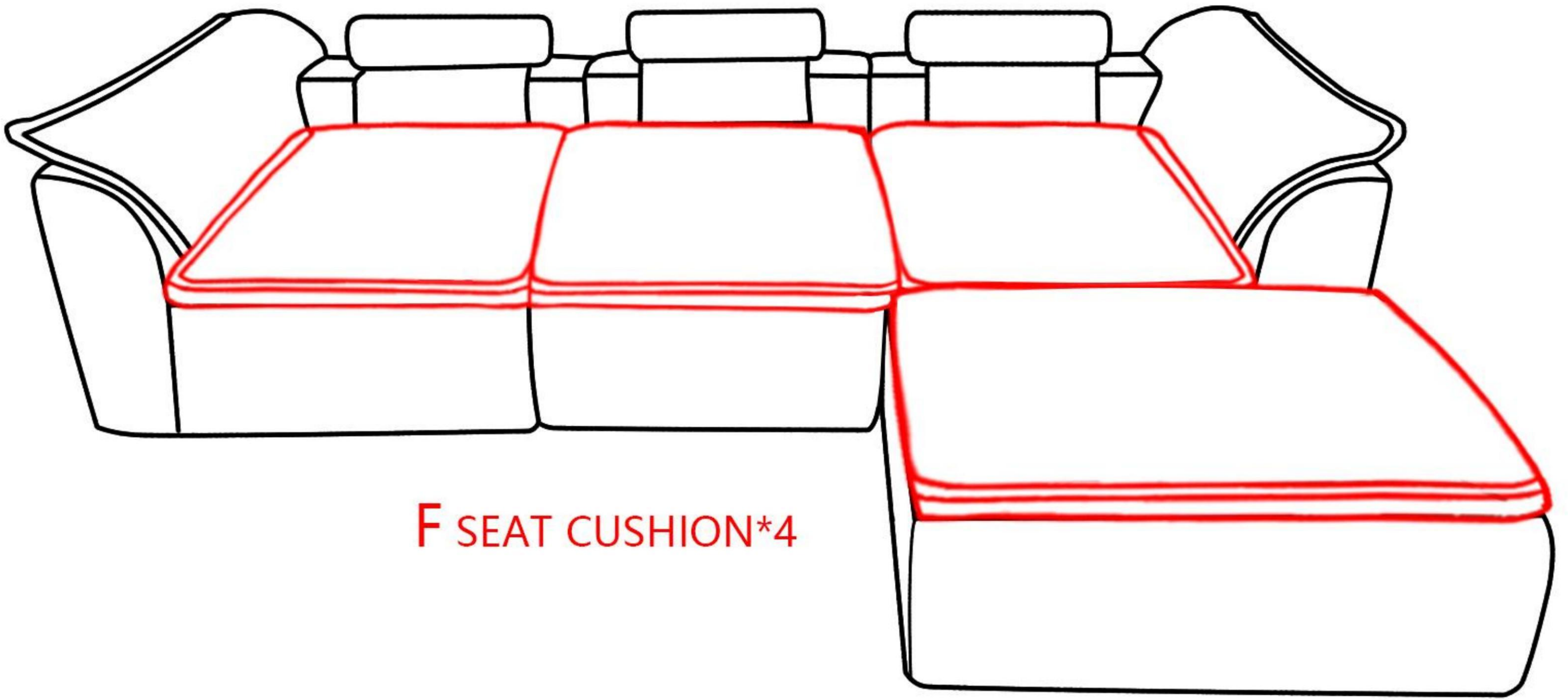

F SEAT CUSHION*4

PUT THE SEAT CUSHIONS ON THE SEATS

STEP 4

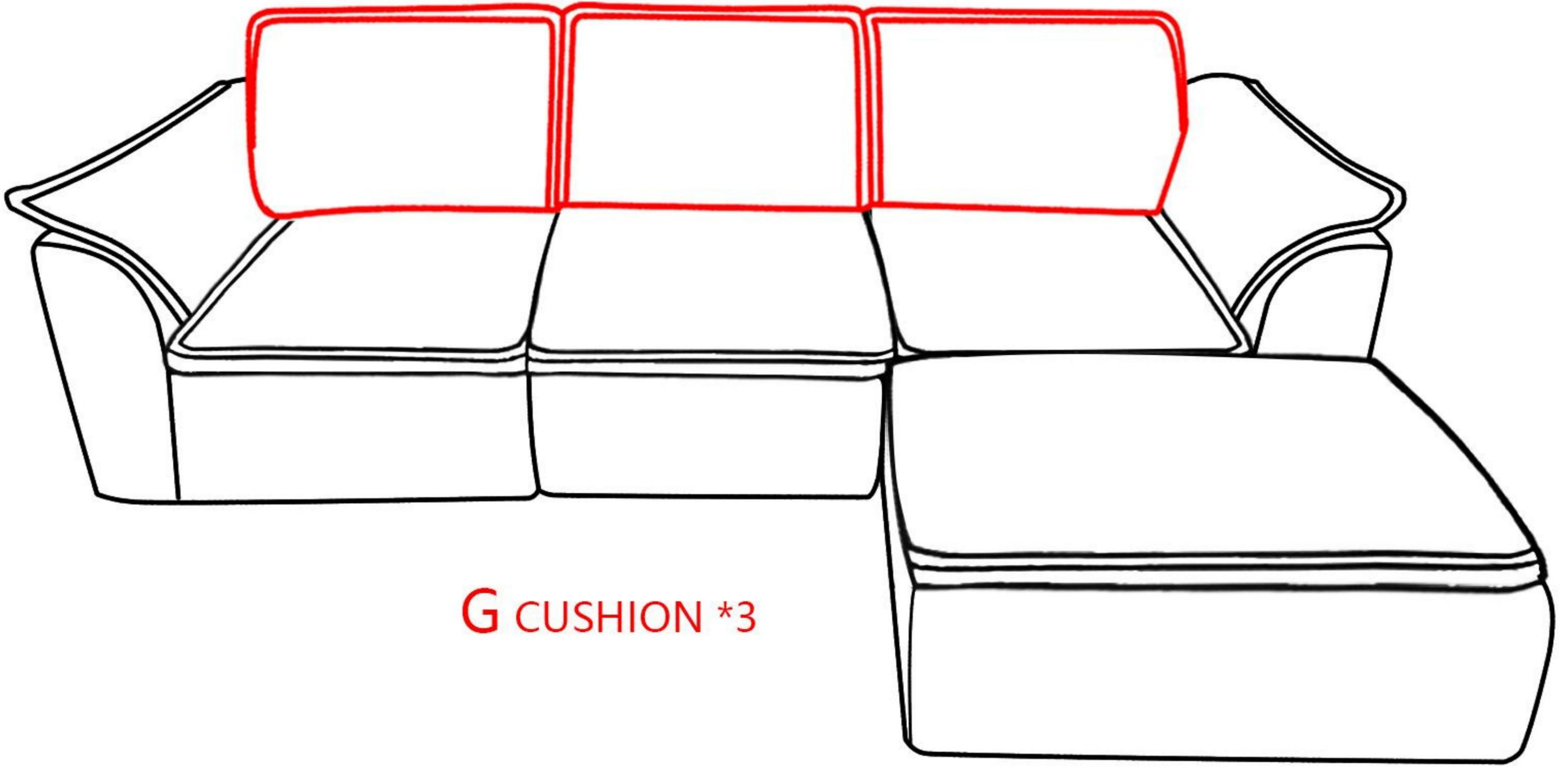

G CUSHION *3

PUT THE CUSHIONS TO THE BACKREST

COMPLETE

