

CHEF KITCHEN WORK STATION # 201  
JET 3190 - JET 3191  
ASSEMBLY INSTRUCTION

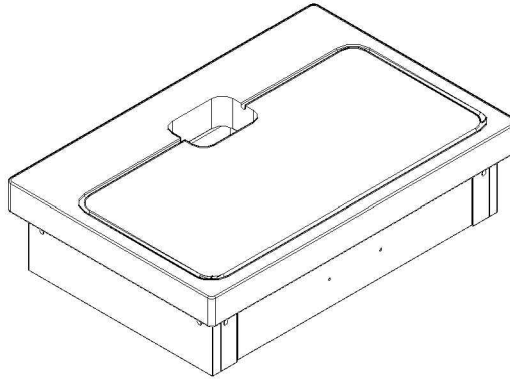

A. TOP AND DRAWER ASSEMBLY



1 EACH

C. LEGS



4 EACH

F. CHEF PAN

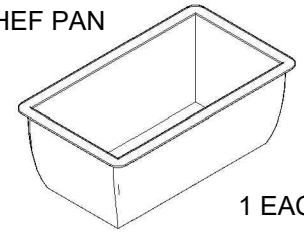

1 EACH

G. HANDLE

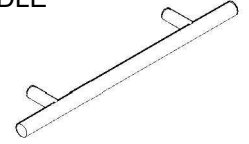

1 EACH

B. SHELF

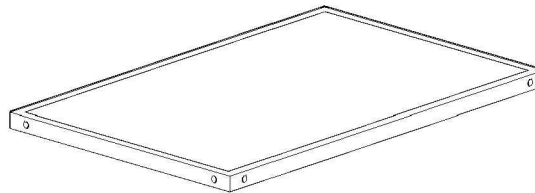

2 EACH

D. TRASH RING



1 EACH

H. TOWER BAR

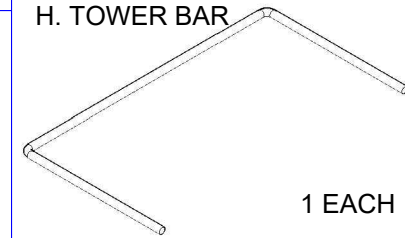

1 EACH

E. "S" HOOK



4 EACH

I. SPEED RACK

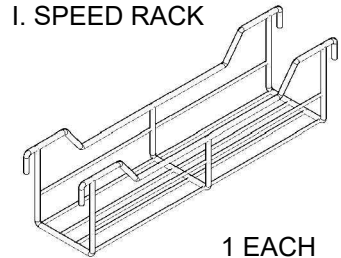

1 EACH

HARDWARE LIST

K. BRAKE

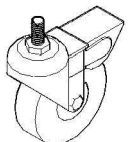

2 EACH

L. WHEEL

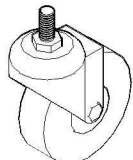

2 EACH

M. SCREW

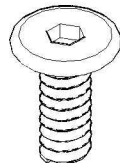

24 EACH

N. NUT

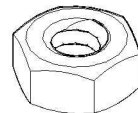

16 EACH

Y. SCREW

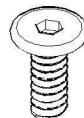

2 EACH

R. NATURAL WOOD PLUG



2 EACH

O. WRENCH

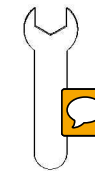

1 EACH

P. ALLEN WRENCH



1 EACH

Oi. OIL

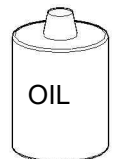

1 EACH

STEP 1

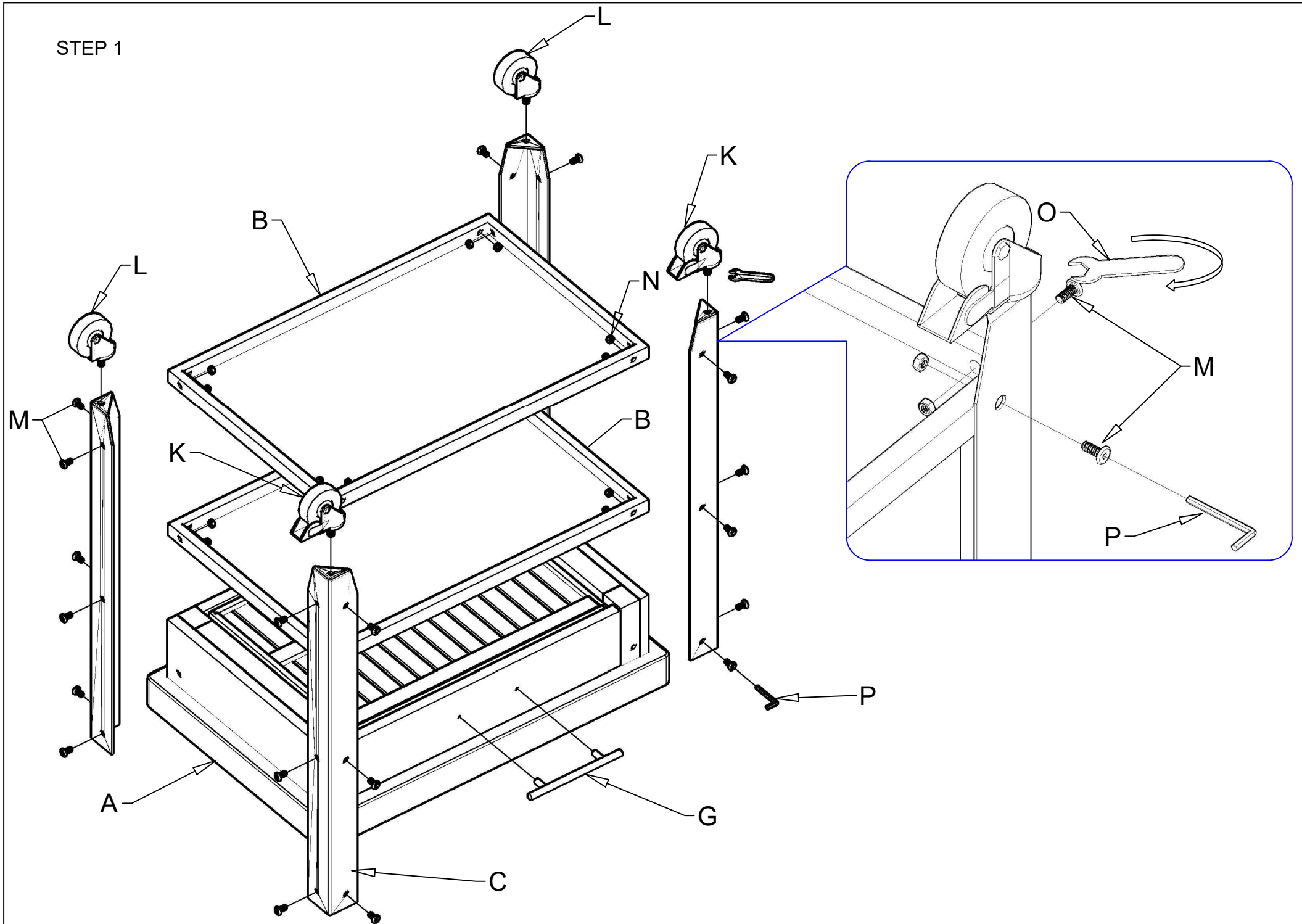

STEP 2

