

# Owner Manual



# WARRANTY

We strive to offer high quality product and we also try our best to satisfy each customer that order from us, no matter on products or services as needed. Each customer receives a record of their order, such as the order number or item receipt. For any items that are out of warranty period, you may still be able to purchase the replacement parts from our company if they are available.



# MAINTENANCE AND WARNING

Please read the manual thoroughly before you start installing.

Please keep the product away from sharp object.

Packaging and small parts may have choking hazard, please keep them away from children and pets.

Please clean the product according to each clean code, check the product description for more information.

Please keep the product away from fire.

If you have any other questions, please contact us, we will be glad to help you out.

If the product is placed under direct sunlight, the pattern or color might fade away overtime.

Check the product periodically to make sure everything is secured and tightened.

Always use proper tools for installation.

Do not jump on the product.

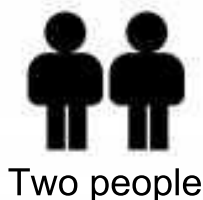

Around 35 min

# PRODUCT DESCRIPTION

High-Quality Fabric: Soft, water-resistant cotton-blend fabric ensures comfort while protecting against outdoor elements.

Generously Padded Cushions: Thick, plush cushions offer excellent comfort for long periods of lounging.

Sleek, Sturdy Frame: The matte black metal frame provides durability and a contemporary look.

Weather Resistance: The fabric resists rain and sun exposure, making it ideal for outdoor use.

Matching Ottoman Included: The ottoman provides additional leg support, completing the lounging experience.

# EXPLODED VIEW

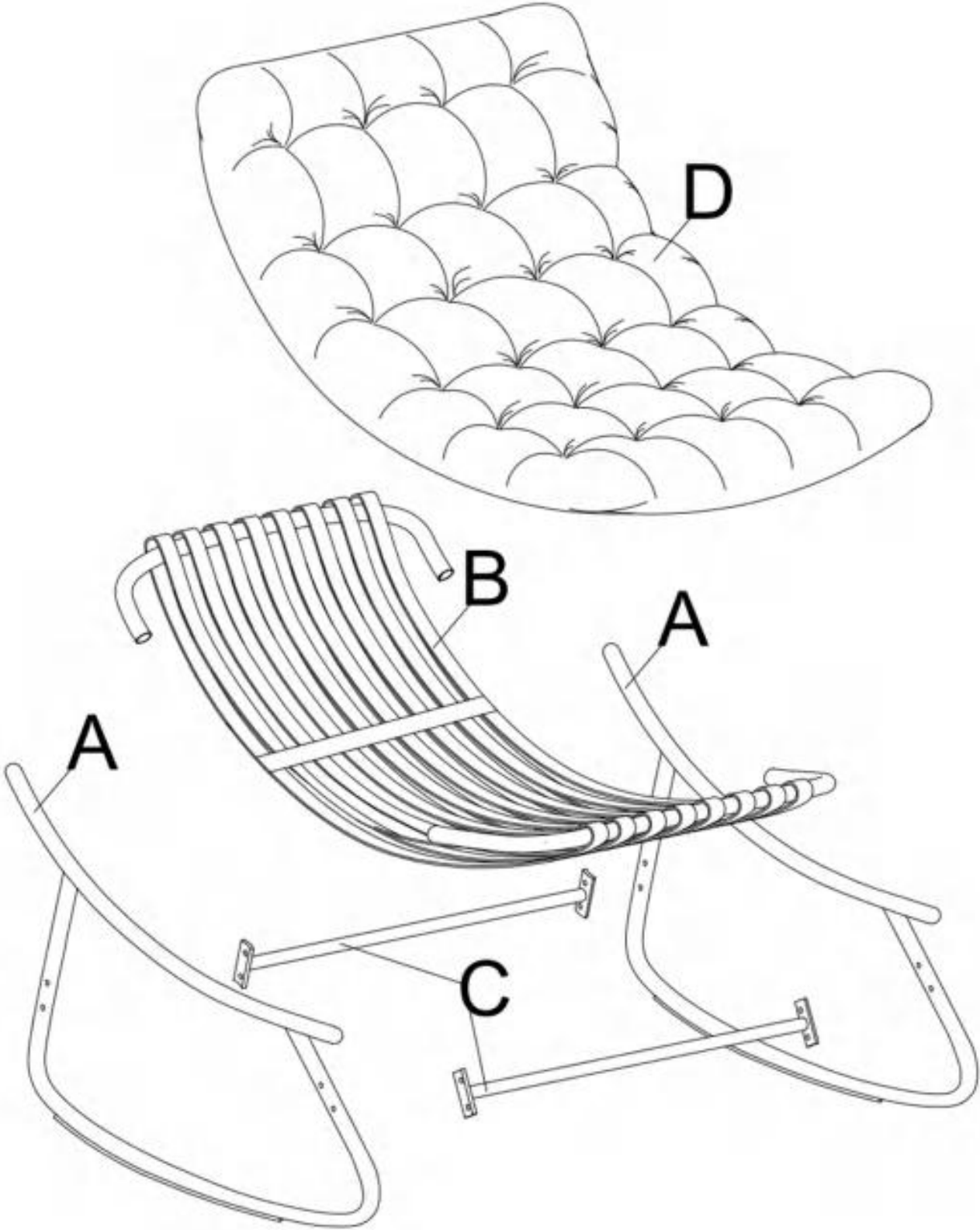

# PARTS

A\*2



Armrest

B\*1



Seat frame

C\*2



Rail bar

D\*1



Cushion

E\*1



Seat cushion

F\*2



Legs

G\*1



Seat frame

# HARDWARE

## TOOL LIST

NOTE: Designated with (★) We provide additional spare parts in the hardware package

①\*8



★ M6\*40mm  
Bolt

②\*16



★ Flat  
washer

③\*8



★ Nut

④\*8



★ Bolt Cap

⑤\*1



Allen key

⑥\*1



Wrench

Please make sure all hardware & packing material fitting the list. Especially some small accessories may be missing during transportation. Please contact us if you have any question.

# step 1

Align the Rail Bars (C) with the Armrests (A), ensuring proper positioning before installation. For each connection point: First, place a flat washer (2) on the bolt, then insert the bolt (1) through the Armrest (A) into the Rail Bar (C), and secure from the Rail Bar (C) side with another flat washer (2) and nut (3). Important: Complete this process for all bolts first, maintaining proper alignment throughout, DO NOT tighten any bolts until the final step.

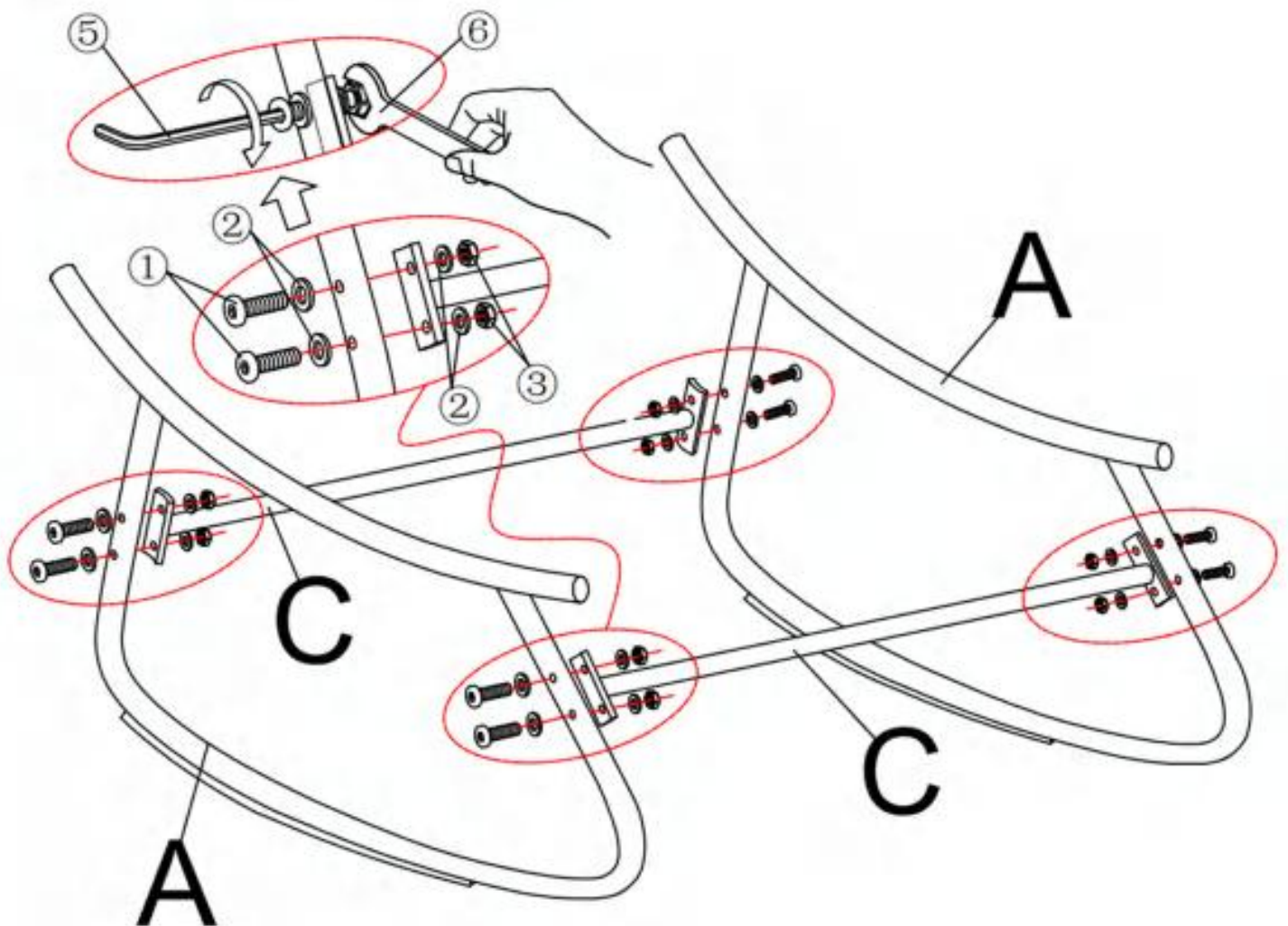

# step 2

Insert the seat frame (B) into the armrest (A) from Step 1.

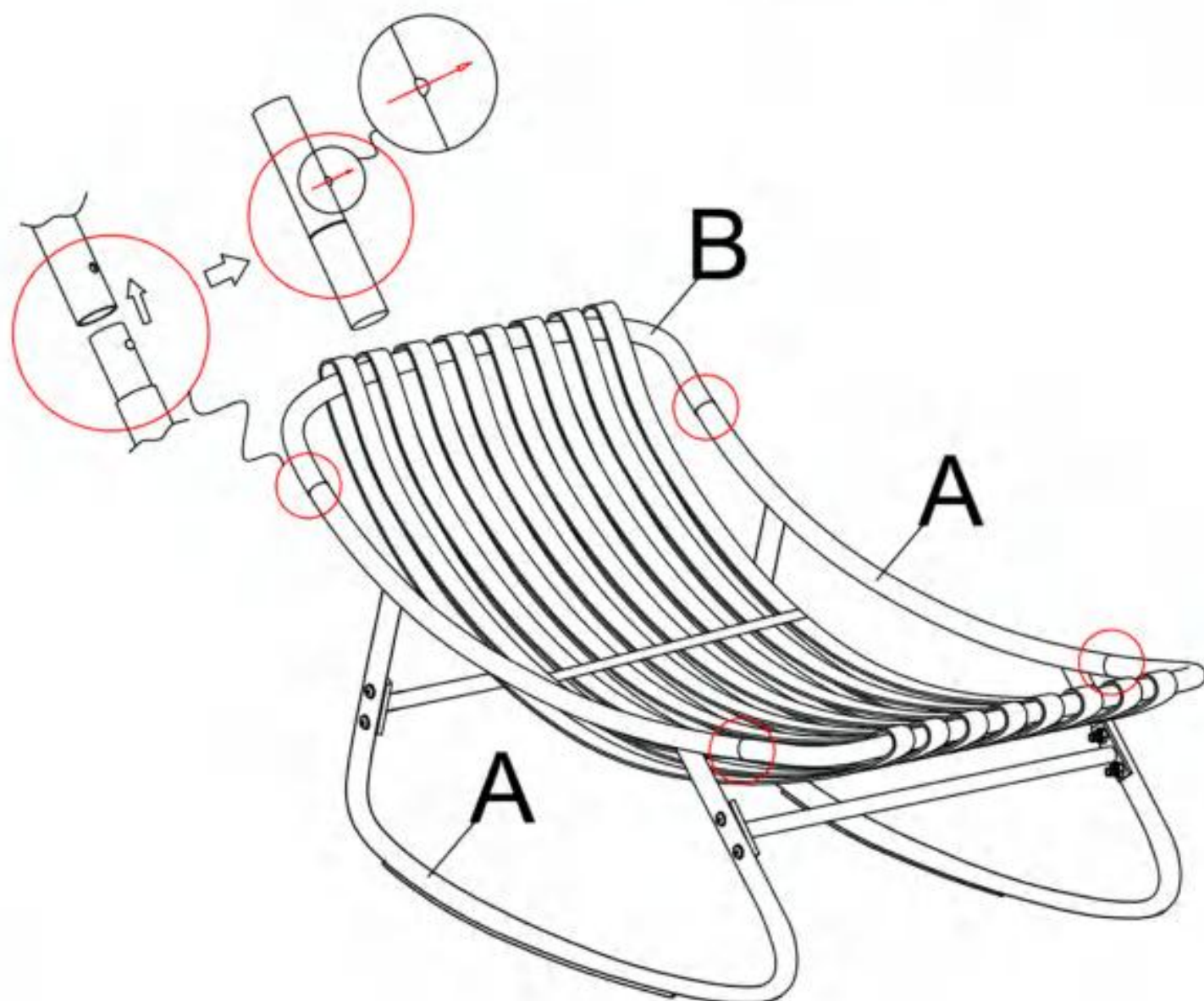
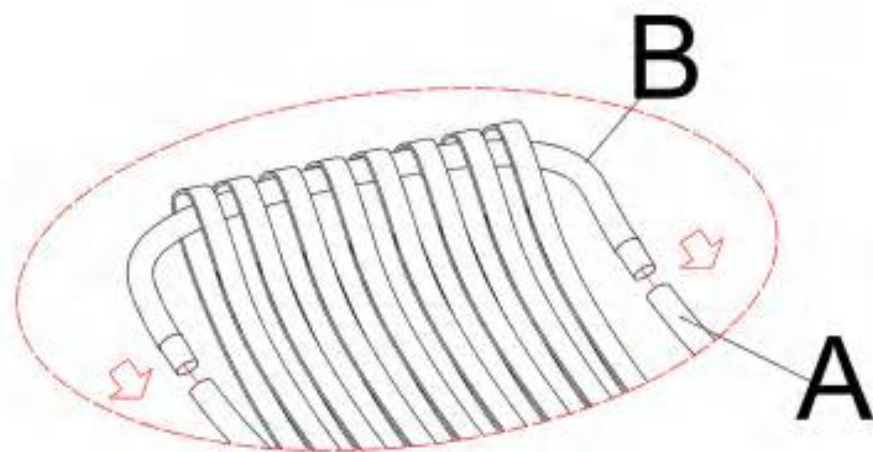

# step 3

Tighten all the nuts with the allen wrench (5) and spanner (6) provided. Then place the plastic cap (4) on the nut as shown.

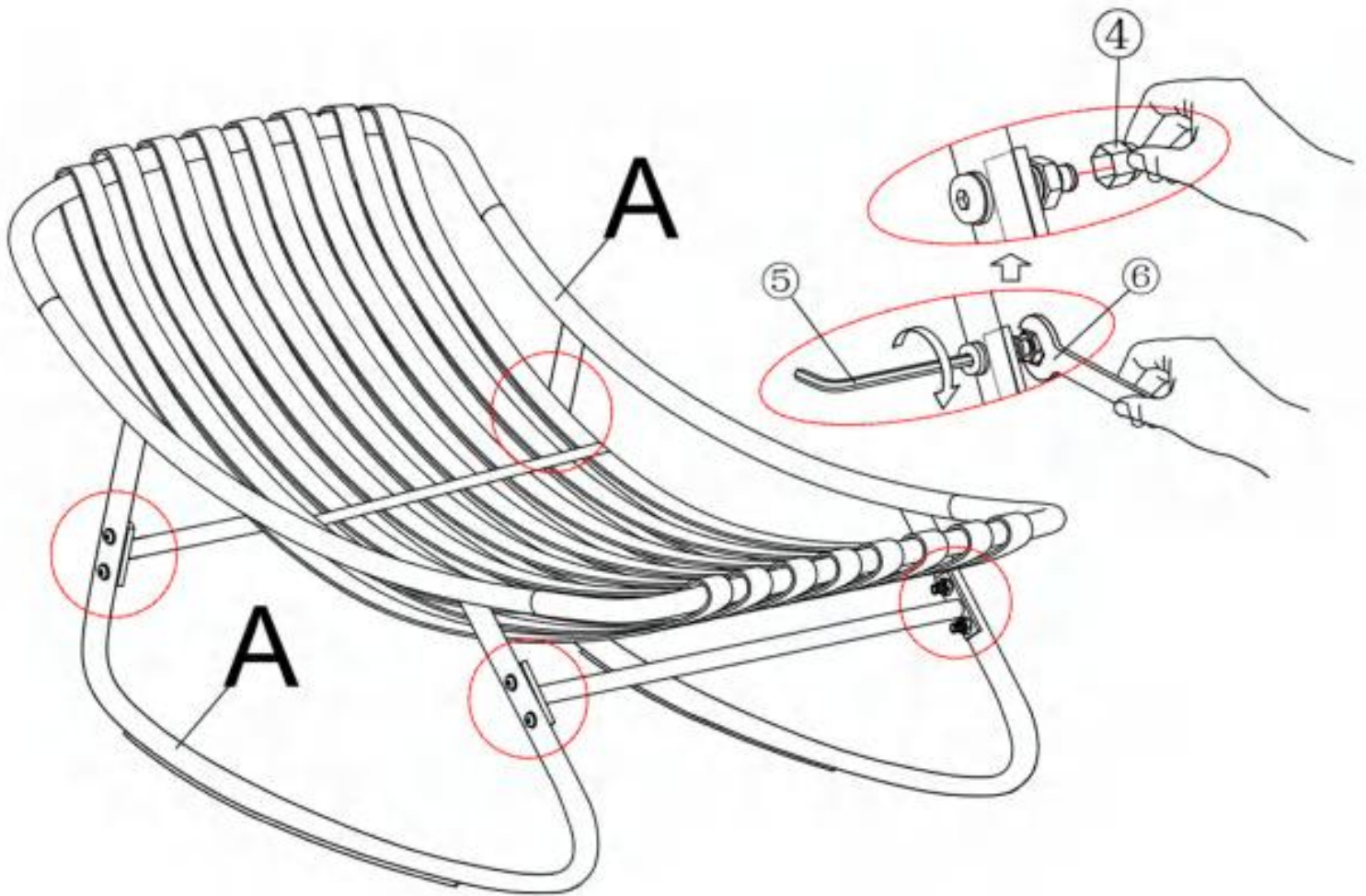

# step 4

Place the cushion D on the chair.

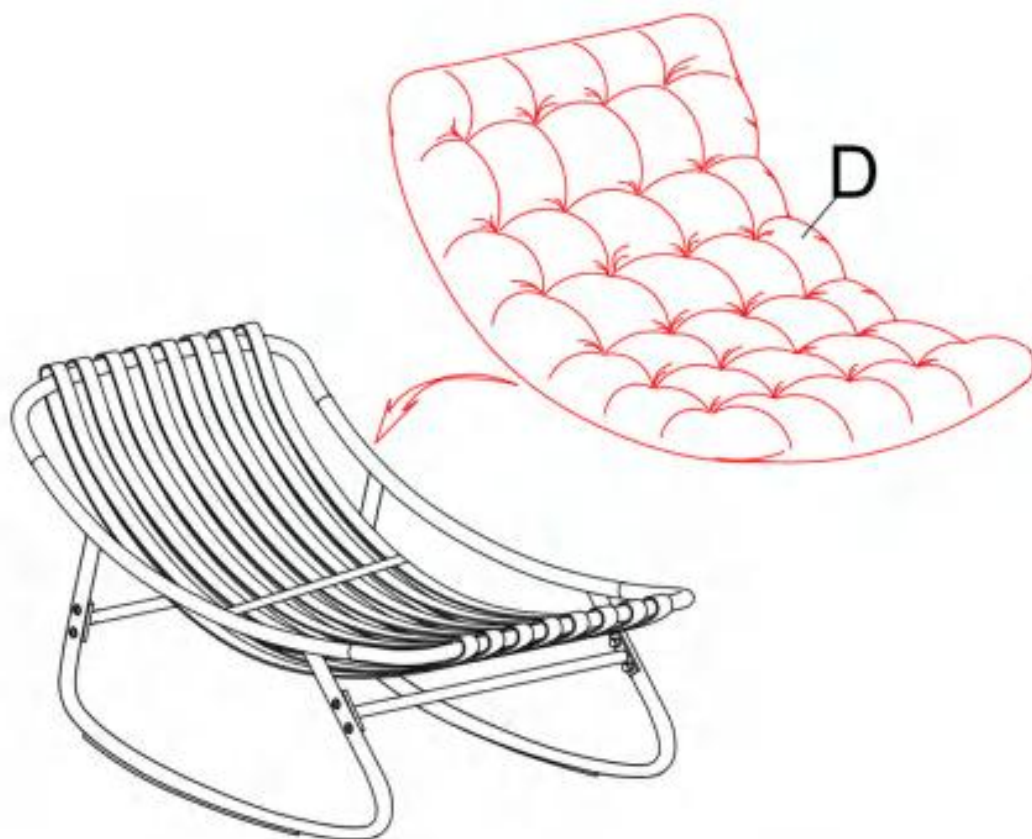

# EXPLODED VIEW

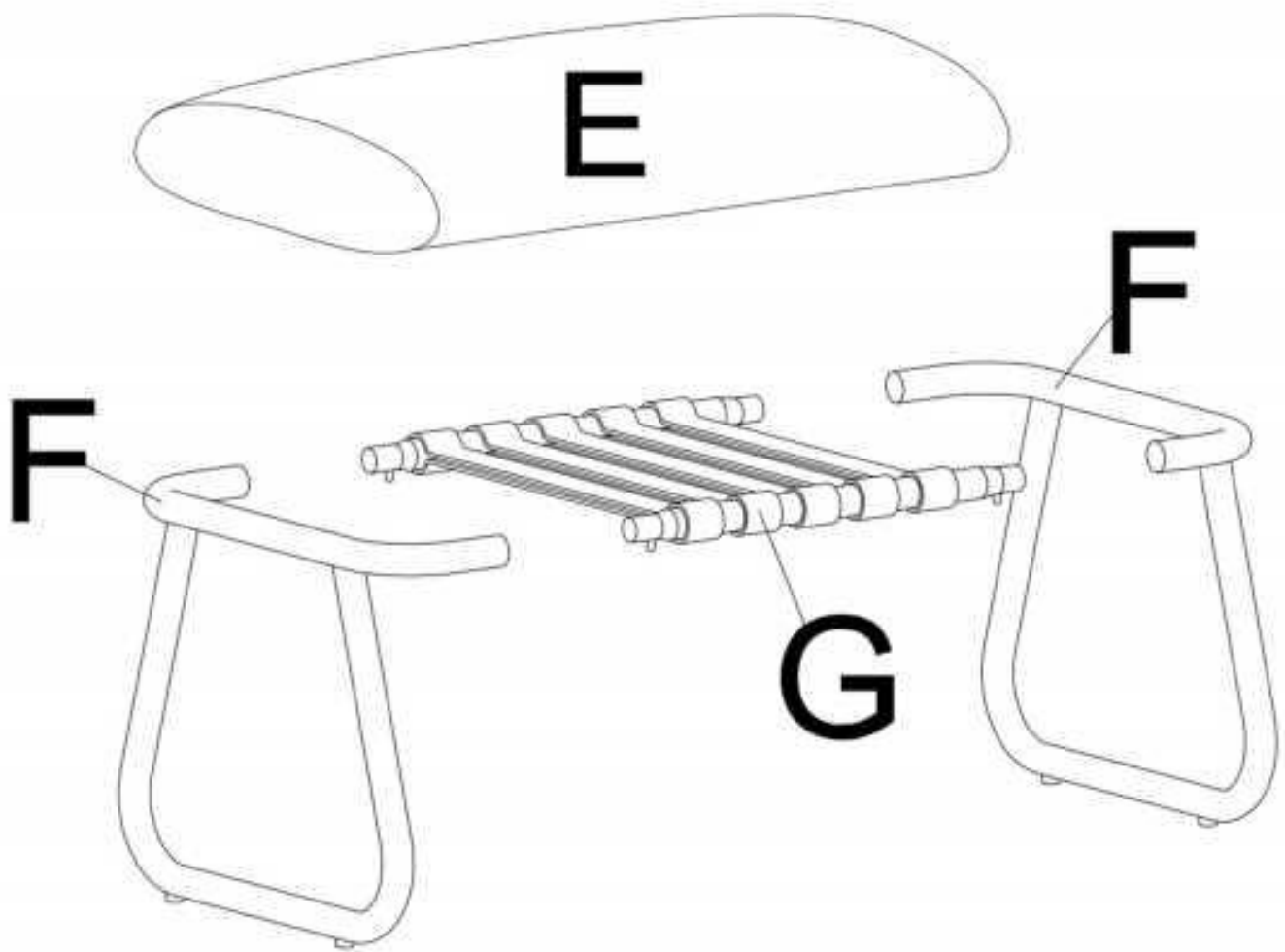

# step 5

Insert the seat frame (G) into the legs (F).  
Place the cushion (E) on the chair.

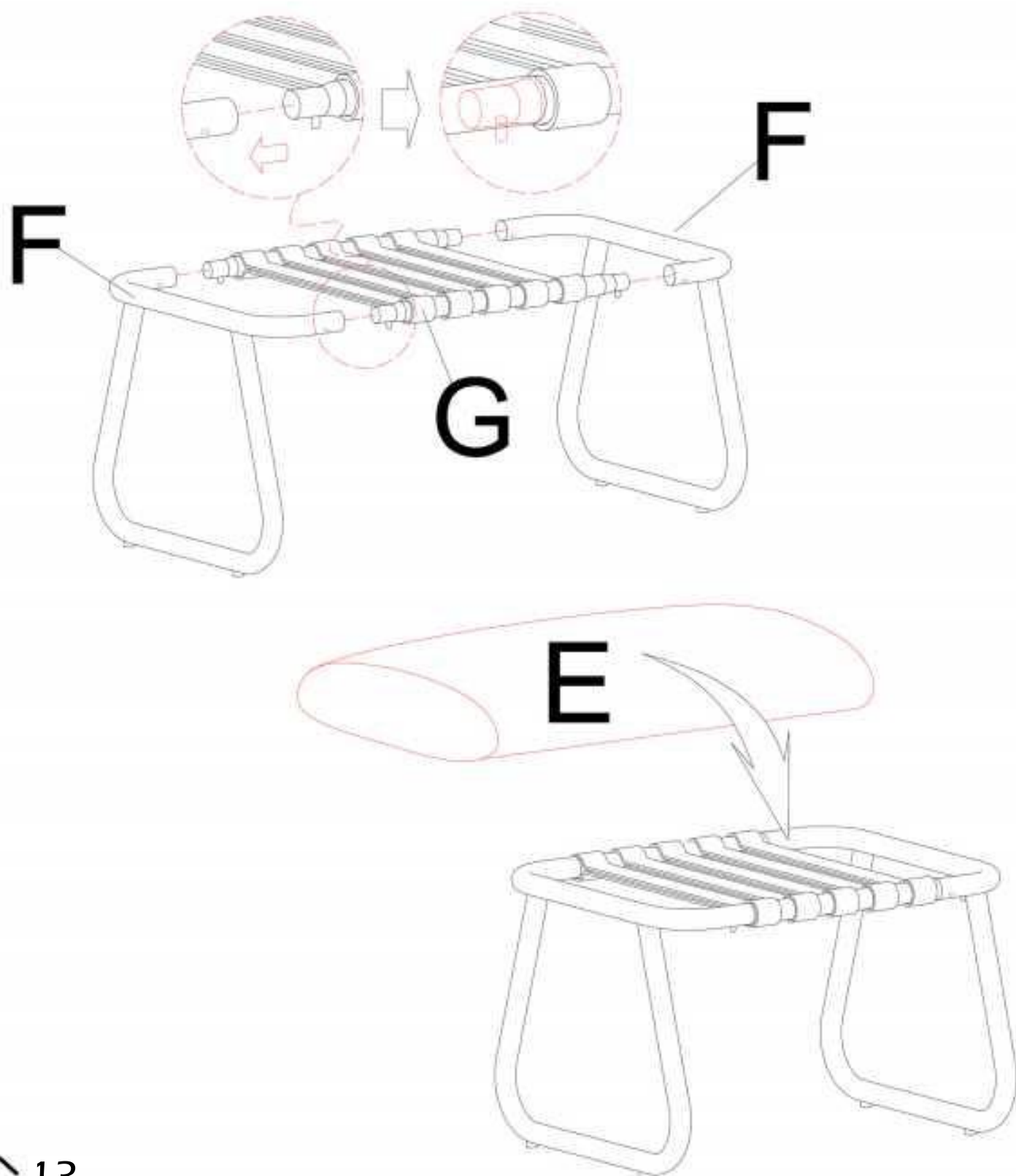

# step 6

