



Chair

Dimension: 61*63*92-100cm

Tips!

Check all the components & screws before assembly. **Do not install in case part is missing, contact us to get.** Send email with your question to support@vecelo.com. We will resend within 24 hours.

Return Policy

We believe you will absolutely love your new item. But if for some reason you want to return, please contact us directly before you decide to return your product. Our customer service organization can answer most concerns and assist you with any questions you may have about your new item, please email us first at: support@vecelo.com. The item must be returned within 30 days of delivery for a full refund. The item must be returned in good condition, in original box, with all original proof of purchase, parts and accessories.

Trouble shooting:

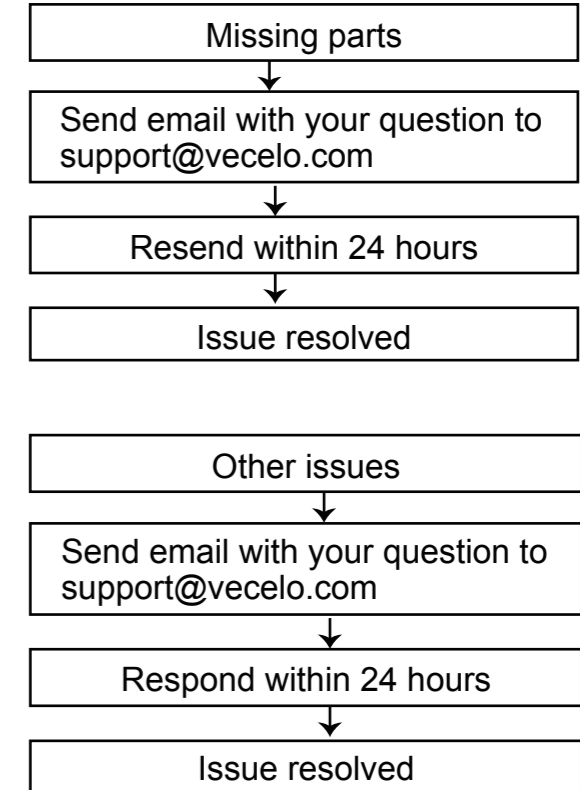

We control manufacturing and distribution ourselves, ensure the quality.

How to find us?

Email: support@vecelo.com

Website: www.vecelo.com



Item Description: Chair
 Dimension: 61*63*92-100cm
 Model NO: ZD-NO.1







Step 6

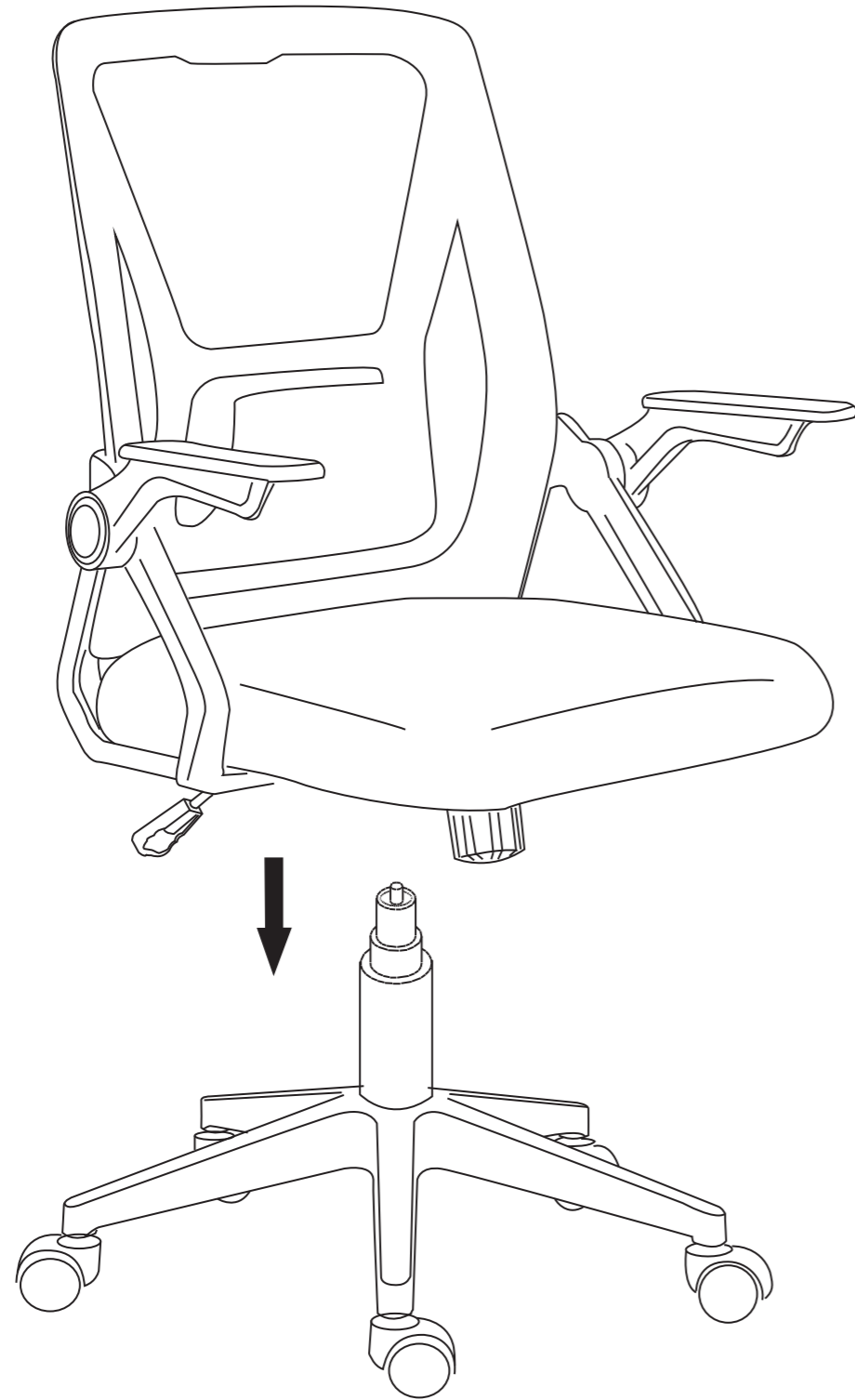

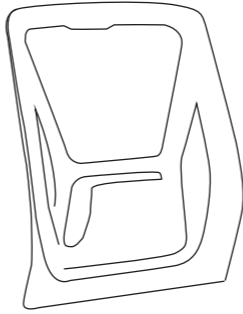
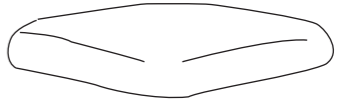
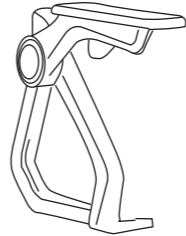
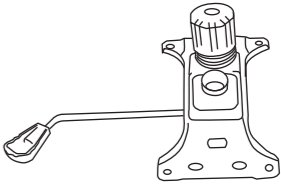
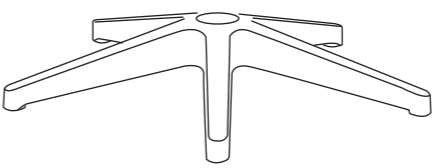

Step 5



Components

A		1pcs	B		1pcs
C		2pcs	D		1pcs
E		1pcs	F		5pcs
G		1pcs	H		1pcs

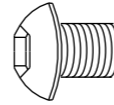
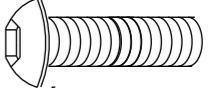
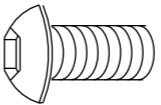
Screws&Tools

I1	 M6*20mm	4pcs	I2	 M6*30mm	4pcs
I3	 M6*25mm	4pcs	J		4pcs

Step 1

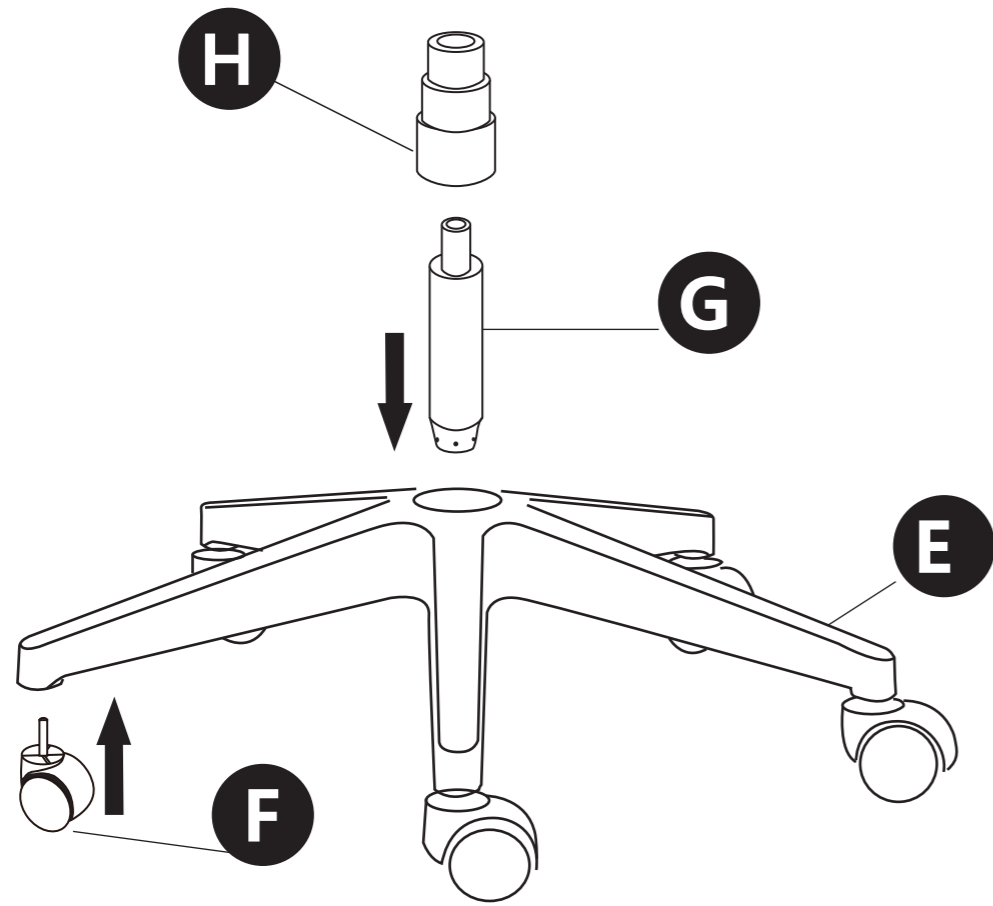

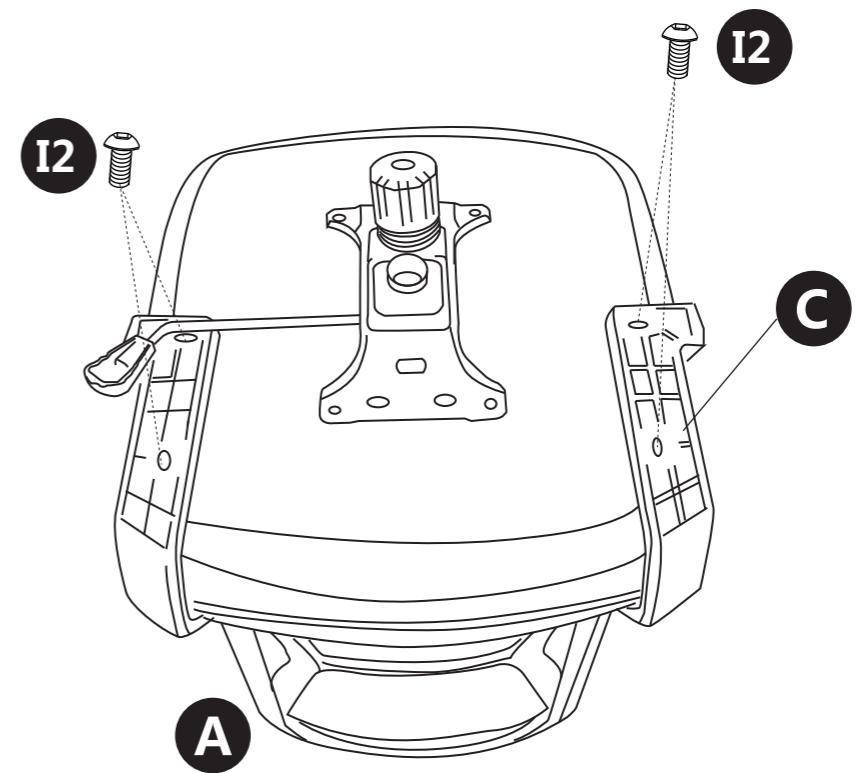

 I2x4

Step 3



Step 2

 I1x4  Jx4

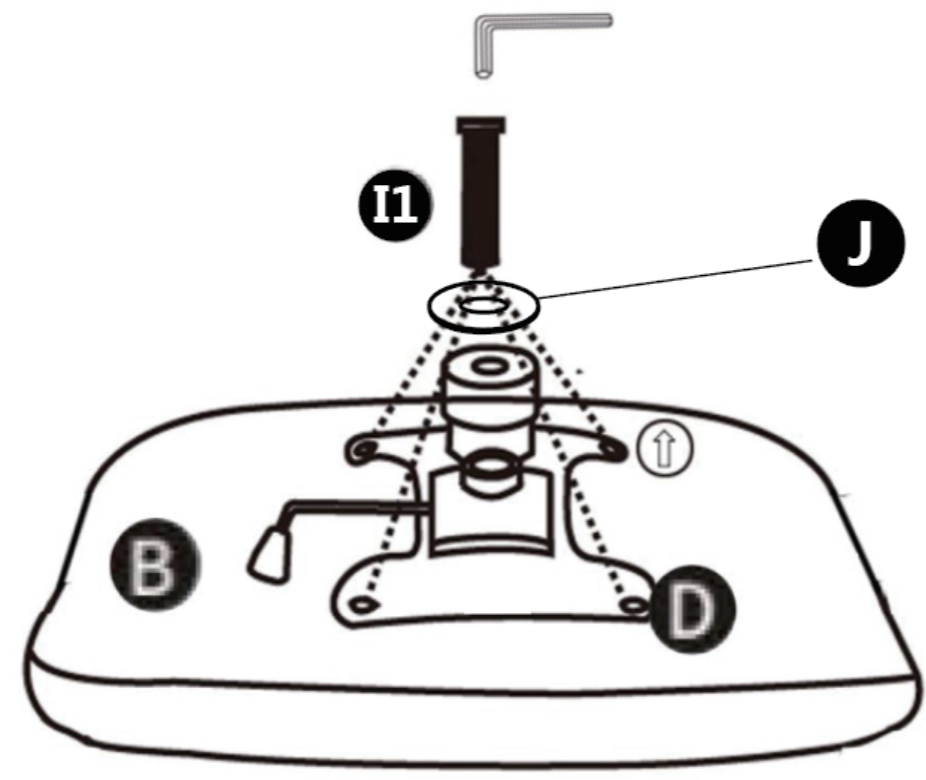

 I3x4

Step 4

