

# Marine Combo

ALL-IN-ONE COMBO WASHER ⊕ DRYER

Model: 4650

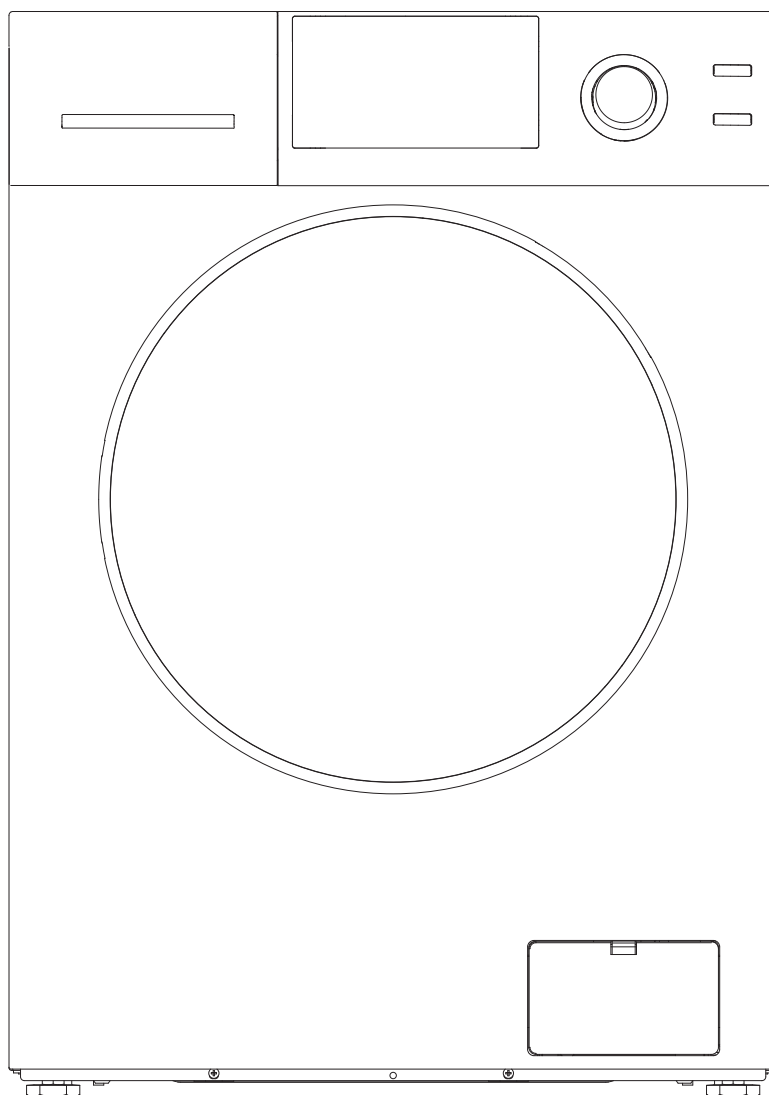

## OWNER'S MANUAL

Read the instructions carefully and keep for future reference. Information maybe updated from time to time so please refer to the website for the latest version of the manual.



**DO NOT RETURN TO STORE!**

**HAVE QUESTIONS OR NEED SERVICE?**



1-800-776-3538



Service@ApplianceDesk.com

# TABLE OF CONTENTS

**Please read the Owner's Manual carefully before using your  
ALL-IN-ONE COMBO WASHER ⊕ DRYER**

Features.....	1
Warranty.....	2
Technical Data.....	5
Important Safety Instructions .....	6
Diagram of the Combo .....	8
Handling and Placement .....	9
Installation Instructions .....	10
Electrical.....	11
Plumbing.....	12
Special Installations Requirements .....	16
Program Selection Chart .....	17
Control Panel.....	19
Maintenance.....	22
Troubleshooting.....	23
Error Codes.....	24

# ***Congratulations on your new Marine Combo!***

In addition to its contemporary design, this is a highly sophisticated engineered product that will give you many years of satisfaction.

## **Here are some of the best reasons for buying your Marine Combo**

1. Cabinet - Galvanized steel with phosphate treatment and painted, to prevent rust
2. Nuts, Bolts, Screws, Clamps - Stainless steel grade 316
3. Terminals and Connecters - Conformal coating to prevent moisture build-up
4. Spider wheel (Containing Bearings): Conformal coating to prevent rust
5. Tub Enamel: 2 coats of enamel on tub to prevent rust
6. Salt Wash: 5 minute initial rinse to remove salt from clothing

## **Upgraded Accessories Included:**

1. Stainless Steel Inlet hoses (2)
2. Galvanized Floor Bracket (2)
3. Aluminum Flexible Duct (5 Feet Length + 2 Clamps)

## **FEATURES**

### **1. Space Saving and Placement Options**

By combining the two functions of washer and dryer in one unit, the space taken for the second unit, i.e. separate dryer, is saved. The sleek and compact size design makes it a perfect appliance for any kitchen or laundry room.

### **2. Water & Energy Saving**

New automatic water level feature determines the amount of water required based on quantity of clothes which helps save water. Also this appliance is engineered to provide valuable energy savings e.g., LED display goes off after 5 mins to save energy.

### **3. Easy Operation**

This appliance is simple to use as a washer or as a dryer – or it can go seamlessly from wash to the dry functions.

### **4. Specialized Wash Programs**

There are special wash programs for Salt Wash, Sanitize, Allergen, Winterize etc.

### **5. Flexible Drying option**

With the option to change from a Ventless Dry (Condensing) system to a Vented Dry, you can decide on the ideal dry system depending on availability of a venting outlet and weather.

### **6. Sensor Dry and Refresh**

The Sensor function automatically selects the ideal dry level to make sure your clothes are dried with utmost perfection based on wash cycle used. The refresh function keeps your clothes warm and fluffy always.

### **7. Lint Free Maintenance**

Since the machine has a self-cleaning pump, this appliance needs no cleaning of lint after drying. Instead, there is a convenient coin trap.

### **8. Portability**

The appliance can be permanently installed or made portable with the installation of the portability kit (Accessory Part #1070 sold separately) where needed.

## WARRANTY INFORMATION

**Your appliance is protected by this warranty under normal, personal, family or household use for 1 Year (Parts and Labor), 2 Years (Motor) and 5 Years (Rust Only) and limited commercial use (90 days) in USA and Canada.**

### WARRANTY

---

Consolidated Brands undertakes to the consumer / owner to repair or, at our option, to replace any part of this product which proves to be defective in workmanship or material under normal personal, family or household use, in USA and Canada, for a period of one year parts and labor, two years motor and five years rust only from the date of original purchase. For commercial use, the product is warranted for a period of 90 days.

During this period, we will provide all labor and parts necessary to correct such defect, free of charge, if the appliance has been installed and operated in accordance with the written instructions provided with the appliance. Ready access to the appliance, for service, is the responsibility of the consumer / owner. If a unit is installed in a closet or cabinet, it should be removed by the consumer / owner, for access by service technicians. If this is not done, there will be an extra charge.

### EXCLUSIONS

---

In no event shall Consolidated Brands be liable for incidental or consequential damages or for damages resulting from external causes such as abuse, operation misuse, neglect, alterations, normal wear and tear, incorrect voltage or acts of God. This warranty does not cover service calls which do not involve defective workmanship, damage due to other products while combined use with this product or materials covered by this warranty. Accordingly, diagnosis and repair costs for a service call which does not involve defective workmanship or materials will be the responsibility of the consumer / owner.

Most work is covered. The defining factor is, has the machine malfunctioned (Consolidated Brands is responsible) or has the customer omitted or done something to cause malfunction (customer is responsible). Some states do not allow the exclusion or limitation of incidental or consequential damages, so the above limitation or exclusion may not apply to you.

You can register your Warranty by either of the following methods:

1. Scan QR Code

- Open Smart Phone
- Open Camera
- Click the Link



2. Register online at [ApplianceDesk.com/Warranty](https://ApplianceDesk.com/Warranty)

3. QR Code is also used to obtain Product Information, Manuals and Updates

### WARRANTY SERVICE

---

This warranty is given by:  
**Consolidated Brands**  
**10222 Georgibelle Drive, Suite 200,**  
**Houston, TX 77043-5249**

Customer Service: **Appliance Desk**  
Phone / Text: 1-800-776-3538  
Email: [Service@ApplianceDesk.com](mailto:Service@ApplianceDesk.com)  
Web: [www.ApplianceDesk.com](http://www.ApplianceDesk.com)  
Business hours: 9:00 am to 5:00 pm weekdays

## **THE FOLLOWING WORK ARE NOT COVERED UNDER WARRANTY:**

---

### **A) Installation**

1. Non-removal of shipping bolts, causing vibration / internal damage.
2. Non-adjustment of feet to level machine, causing vibration / internal damage.
3. Non-removal of exhaust vent plate at the back while using Venting Dry mode, causing excess heat and resulting in damage to internal components.
4. Not conforming to minimum space requirements for built-in installation, causing excess heat and resulting in damage to internal components.
5. Using incorrect length of venting i.e. more than 10 feet unless used with a booster exhaust fan.
6. Installation in a corrosive environment.
7. Incorrect water pressure i.e., below 7.25 psi or above 145 psi.
8. Incorrect water inlet hose installation (use only factory supplied hoses with metric threads on the L-shaped side to fit water valve).

### **B) Maintenance**

1. Non-cleaning of coin trap for debris, causing the unit to not drain out water and resulting in drain pump malfunction.
2. Non-cleaning of exhaust fan and exhaust hose for lint, causing the unit to not dry properly.
3. Improper maintenance (such as, but not limited to, scale build-up, freeze damage, or vent blockage).

### **C) Damage**

1. Breakage of cosmetic parts e.g., door handle, knob.

### **D) Other**

1. Accident, abuse, or misuse.
2. Using solvents to clean the machine or wash clothes, causing damage.
3. Misapplication of this product e.g., use in a non-household / commercial environment.
4. Any other cause not due to defects in materials or workmanship.
5. Problems or damage due to fires, flooding, electrical surges, freezing or any acts of God.
6. Any damage caused by poor water quality.
7. Operating the appliance with anything other than potable water at all times.
8. Force majeure.

## **Warranty Limitations**

1. If a unit is located more than 25 miles away, there will be a trip charge.
2. If a unit is in a remote area more than 75 miles away, the machine should be taken to the technician's workshop.
3. If the unit is installed in a 5th wheel RV, in a location behind the axle, it will not be covered under warranty.
4. All repairs or replacements are warranted only for the remainder of the original warranty period.
5. If a return or replacement is required, allow 3-4 weeks to process.
6. Replacement units will be delivered with curbside delivery only.
7. We may require the return of products or parts to our warranty department for which the shipping charges are to be pre-paid by the consumer / owner.
8. Charges may be incurred if warranty coverage is not applicable.
9. Service would be provided from Monday to Friday between normal business hours.

## **GENERAL**

---

Since it is the responsibility of the consumer / owner to establish the warranty period by verifying the original purchase date, Consolidated Brands recommends that a receipt, delivery slip or some other appropriate payment record be kept for that purpose. This warranty gives you specific legal rights, and you may also have other rights which vary from state to state.

All rights reserved. Manual subject to change without notice.

## TECHNICAL DATA

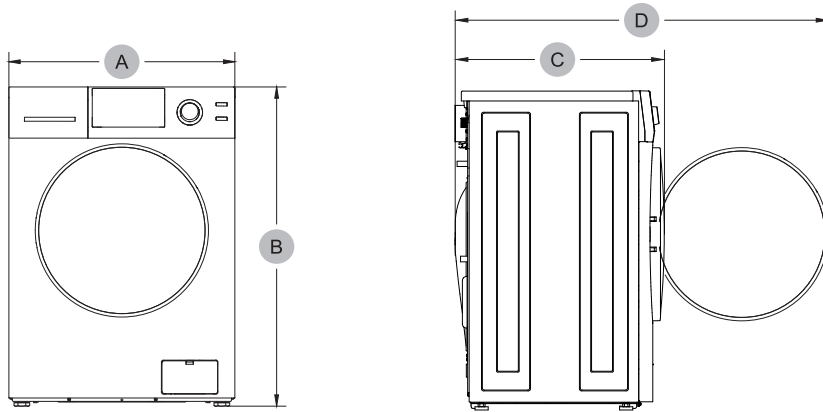

Type		Front loading washer-dryer combo	
Model		<b>4650</b>	
Dimensions (inches / mm)	A. Width	23.6 / 600	
	B. Height-overall	33.5 / 850	
	C. Depth	21.85 / 555	
	D. Depth with door open	38.54 / 979	
Rated voltage		110-120V / 60Hz 12A	
Water pressure (psi / Mpa)		7.25 - 145 / 0.05- 1.00	
Wash capacity (lb / kg)		15.0 / 7.0	
Dry capacity (lb / kg)		Max. 7.7 / 3.5	
Net weight (lb / kg)		161 / 73	
Spin revolution		Max. 1,400 rpm	
Power consumption (W)	Washing	120 V	120 W
	Spin	120 V	500 W
	Wash heater	120 V	1,000 W
	Dry heater	120 V	1,300 W



**Intertek**  
4007606

**US    N° 4007606    CANADA**

*The ETL Listed Mark is the legal equivalent to the UL and CSA Listed Marks*

**Note:** All rights reserved.  
Designs, Specifications and Manual subject to change without notice.

## IMPORTANT SAFETY INSTRUCTIONS

**Your Combo Washer ⊕ Dryer has been built in compliance with safety regulation to protect you and your family.**

**WARNING** – To reduce the risk of fire, electric shock, or injury to persons when using your appliance, follow basic precautions, including the following:

1. Read all instructions before using the appliance.
2. Do not wash or dry articles that have been previously cleaned in, washed in, or spotted with gasoline, dry-cleaning solvents, other flammable or explosive substances, as they emit vapors that could ignite or explode.
3. Do not allow children to play on or in the appliance. Close supervision of children is necessary when the appliance is used near children.
4. Before the appliance is removed from service or discarded, remove the door.
5. Do not reach into the appliance if the tub or drum is moving.
6. Do not install or store this appliance where it will be exposed to the weather.
7. Do not tamper with controls.
8. Do not repair or replace any part of the appliance or attempt any servicing unless specifically recommended in the user-maintenance instructions or in published user-repair instructions that you understand and have skills to carry out.
9. Do not add gasoline, dry-cleaning solvents, or other flammable or explosive substances to the wash water. These substances give off vapors that could ignite or explode.
10. Under certain conditions, hydrogen gas may be produced in a hot water system that has not been used for 2 weeks or more. **HYDROGEN GAS IS EXPLOSIVE.** If the hot water system has not been used for such a period, before using a washing machine or combination washer-dryer, turn on all hot water faucets and let the water flow from each for several minutes. This will release any accumulated Hydrogen.
11. Do not use fabric softeners or products to reduce static unless recommended by the manufacturers of the fabric softener product.
12. Do not use heat to dry articles containing foam rubber or similarly textured rubber-like materials.
13. Check the Coin Trap every few months to remove any coins, buttons or similar size objects.
14. For vented washer-dryers keep the exhaust opening and surrounding areas free from accumulation of lint, dust, and dirt.
15. Do not place items exposed to cooking oils in your dryer. Item contaminated with cooking oils may contribute to a chemical reaction that could cause a load to catch fire.
16. To reduce the risk of fire due to contaminated loads, the final part of a tumble dryer cycle occurs without heat (cool down period). Avoid stopping a tumble dryer before the end of the drying cycle unless all items are quickly removed and spread out so that the heat is dissipated.



---

**SAVE THESE INSTRUCTIONS**

---



## SAFETY

 <b>CAUTION</b> 	The model number and the serial number are on the label affixed to the back of the unit. These numbers are also available on the front of the cabinet behind the door.
<b>RISK OF ELECTRIC SHOCK DO NOT OPEN</b>	You should note the model and serial numbers of this unit in the space provided. Retain this booklet as a permanent record of your purchase to aid in identification in the event of theft.
<b>CAUTION: TO REDUCE THE RISK OF ELECTRIC SHOCK, DO NOT REMOVE COVER (OR BACK). NO USER SERVICABLE PARTS INSIDE. REFER SERVICING TO QUALIFIED SERVICE PROFESSIONALS.</b>	MODEL No: _____ SERIAL No: _____

### Safe Disposal

Before discarding the appliance, please remove the door to prevent risk of child entrapment.

Keep children away from the shipping carton and packing components.

Please dispose of this appliance and all packaging material in accordance with local regulations.

#### California Proposition 65

WARNING: This product contains chemical known to the State of California to cause cancer and birth defects or other reproductive harm.

## HELPFUL HINTS

1. Your Washer⊕Dryer spins at a high 1400 rpm spin speed, which will extract more water especially from absorbent fabrics and reduce the degree of dampness as the machine goes into the drying mode. This will cut down on your drying time.
2. **FABRIC SOFTENER:** After the wash cycle, the clothes can get stuck to the sides of the drum. USING LIQUID FABRIC SOFTENER WILL CAUSE THE CLOTHES TO UNSTICK IMMEDIATELY AND TUMBLE IN THE DRY CYCLE. THIS HELPS TO DRY CLOTHES FASTER AND CAUSES LESS WRINKLES.
3. **OVERLOADING:** The drum has a capacity of 19 lbs. The drum should be loaded only to 2/3 of its capacity otherwise it reduces air flow and causes increase in dry time.
4. **DRYING:**
  - A) Condensing - Since there is no external exhaust system, the moisture content remains in the machine. Frequently when it seems the clothes are damp, it is actually the remaining moisture (like dew). Take clothes out and they will dry within a few minutes.
  - B) Venting - It uses hot air to dry the clothes.
5. **USE HIGH EFFICIENCY (HE) DETERGENT:** By using High Efficiency (HE) detergent, you are preventing suds from entering the condensing chamber. When suds enter the condensing chamber, the particles can clog up the chamber and the fan blower. Over time, this reduces drying efficiency and may require the fan blower (impeller) to be cleaned. For this and all other front-loading/horizontal-axis units, Front Loading detergents go a long way to improve the efficiency of the units.
6. **SORTING:** When sorting laundry always take into consideration the quantity and type of fabric contained in the load. Highly absorbent fabrics such as those used in towels or jeans will absorb more water and become very heavy when saturated. If you notice that your clothes are taking longer than usual to dry you may be overloading the machine, or washing too many highly absorbent articles in a single load.

# DIAGRAM OF THE COMBO WASHER ⊕ DRYER

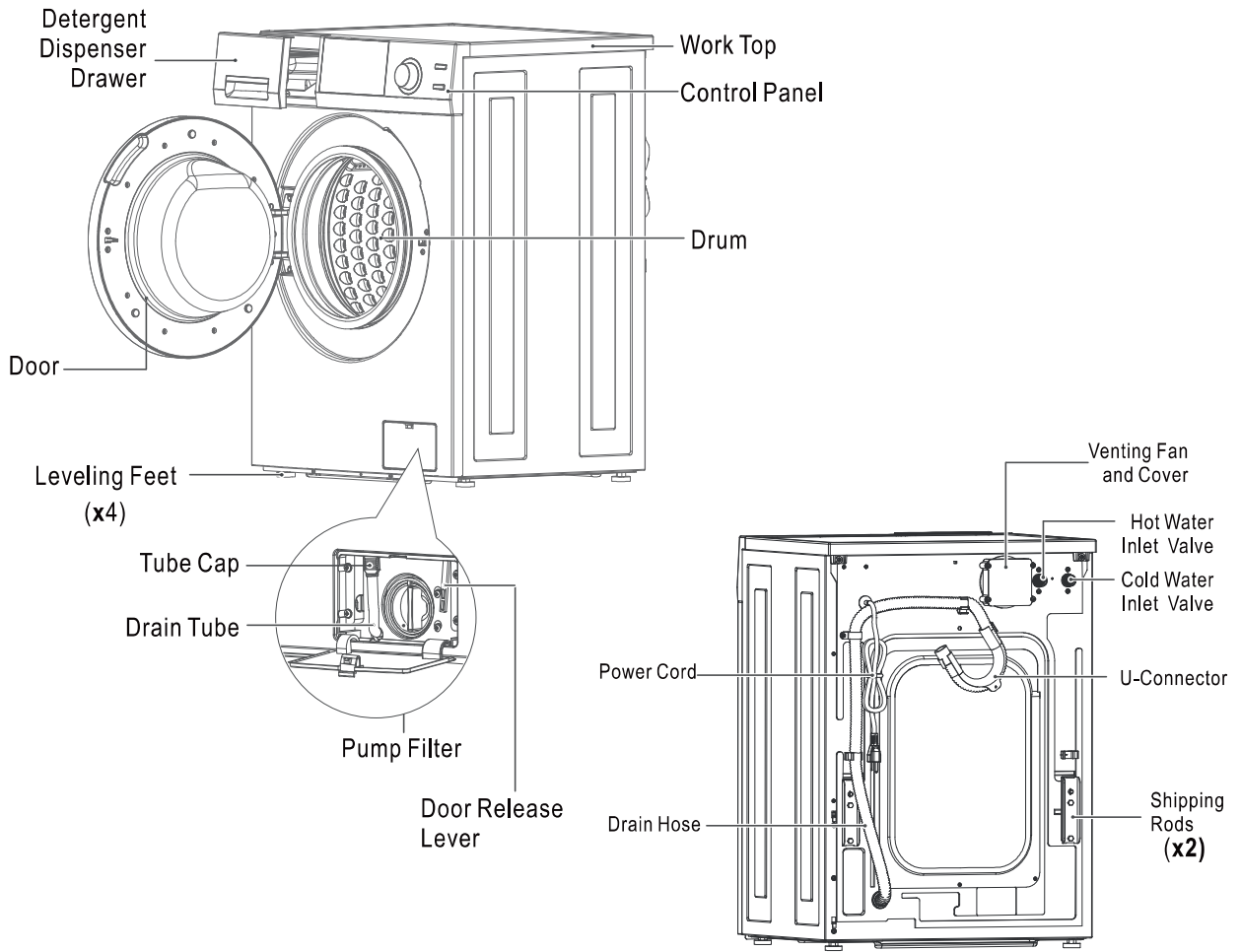

## Factory supplied accessories



Water hoses (Cold/Hot)



Caps for covering shipping rod holes

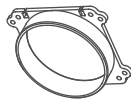

Vent Adapter

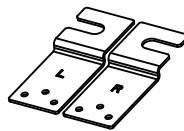

Floor Brackets with screws (x6)

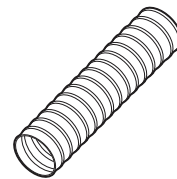

Exhaust hose

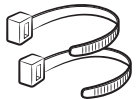

Hose tie (x2)

**Ensure all accessories are included with your appliance.  
Call Customer Service if any items are missing: 1-800-776-3538**

## HANDLING AND PLACEMENT

Remove the packing and check that the appliance is undamaged. If you have any doubt, do not use the appliance and call Customer Service. Keep all packing parts (plastic bag, foam rubber, screws, etc.) out of the reach of children since they could be dangerous.

**Important:** The inside of the appliance consists of a free floating drum that is affixed with shipping rods at the back of the cabinet during transport (Fig.1). The power cord can be accessed by removing the shipping rods (Fig. 2 & 3). Close the holes left open by the rods with the caps provided (Fig. 4). The screws also need to be reinstalled (Fig. 4).

It is important for the machine to be perfectly level. For this reason, the machine is fitted with adjustable feet used for leveling the machine before use (Fig. 5).

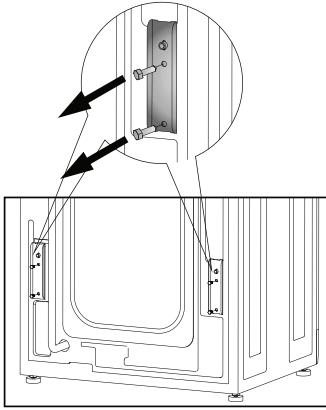

Fig.1

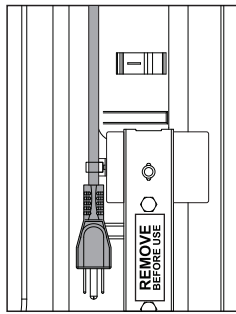

Fig.2

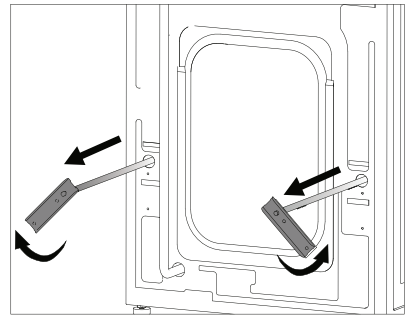

Fig.3

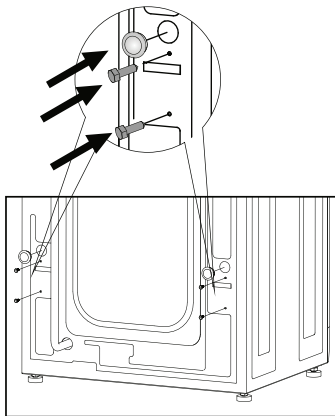

Fig.4

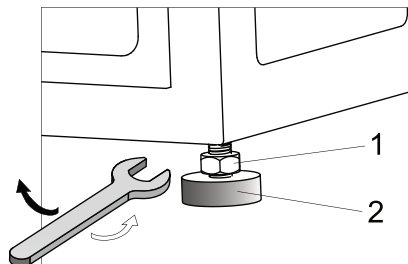

Fig. 5

### ! NOTE

- Save the bolt assemblies for future use. To prevent damage to internal components, DO NOT transport the washer-dryer combo without reinstalling the shipping bolts.
- Failure to remove shipping bolts and retainers may cause severe vibration and noise, which can lead to permanent damage to the combo.
- The cord is secured to the back of the combo by a clamp with a shipping bolt to help prevent operation with shipping bolts in place.

## INSTALLATION INSTRUCTIONS

Do not drag the appliance

Do not hold protruding parts when lifting.

Install the appliance on a firm level surface.

Ensure the appliance is placed in a dry, well ventilated area.

Do not install the appliance outdoors where it can be exposed to freezing conditions.

**Secure the appliance to the floor using the floor brackets provided.**

1. Level the appliance

- Tighten the two back feet so they are all the way in.
- Tilt the appliance back. Then adjust the two front feet up or down so the appliance does not rock side to side, or front to back when upright.

2. Place the brackets around the front feet (Fig.6).

3. Secure both brackets to the floor using a drill and 3 screws each (Fig.7).

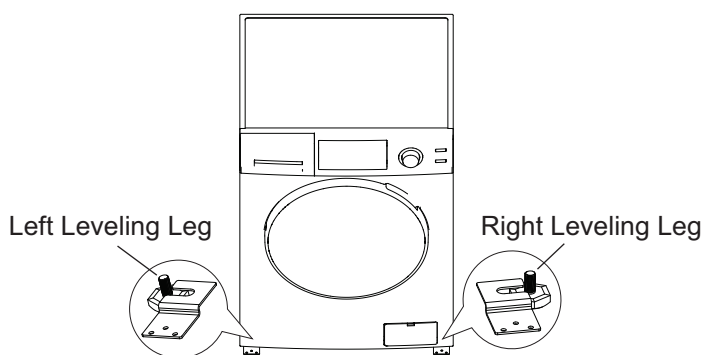

Fig. 6

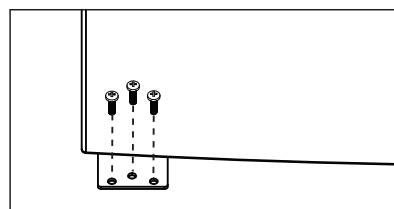

Fig. 7

***Note: Any residual moisture inside the drum is due to the final testing which every appliance undergoes before leaving the factory.***

## ELECTRICAL

### CONNECTION

Connect the plug to a power outlet - 110V/60Hz with minimum 15 Amps. Make sure that the voltage and frequency available correspond with those stated on the serial number plate located on the machine. Do not use adaptors or extension cords since they could result in overheating and burn out.

### POWER SUPPLY

This Washer⊕Dryer must be connected to an individual circuit identical to the one specified on the rating plate of the loading port protected by fuses or circuit breaker conforming to local codes.

### GROUNDING

This appliance must be grounded. In the event of malfunction or breakdown, grounding will reduce the risk of electric shock by providing a path of least resistance for electric current. This appliance is equipped with a power cord having an equipment-grounding conductor and a grounding plug. The plug must be plugged into an appropriate outlet that is properly installed and grounded in accordance with all local codes and ordinances.

### WARNINGS

- Improper connection of the equipment-grounding conductor can result in a risk of electric shock. Check with a qualified personnel or service representative if you are in doubt as to whether the appliance is properly grounded.
- Do not modify the plug provided with the appliance: if it will not fit the outlet, have a proper outlet installed by a qualified electrician.

***Note: If the electrical power supply does not meet the specifications listed above, please call a licensed electrician.***

# PLUMBING

## CONNECTING TO THE WATER FAUCET

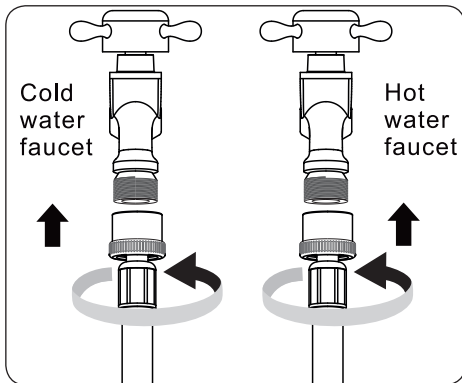

Fig.8

To connect the hoses to the water faucets:

- Connect the straight end of each hose to the cold or hot faucet.
- Turn the fittings by hand until they are tight, and then tighten them by just an additional two-thirds of a turn with a plier. Do not overtighten the fittings. They can be damaged.
- When done, pull the water hoses up and down to check if they are properly connected.

## CONNECTING TO THE MACHINE

To connect the hoses to the machine:

- Connect the L-shaped end of each hose to the cold or hot water valve on the rear of machine.
- Open both the faucets, and check if there is a leak.

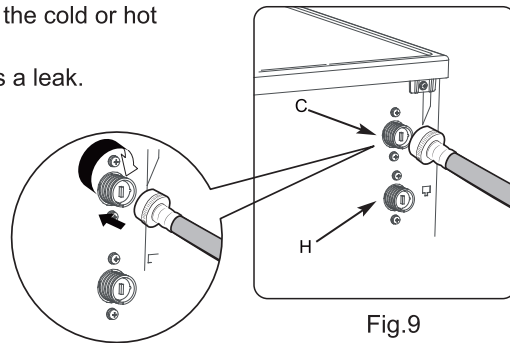

Fig.9

## CONNECTING THE DRAIN HOSE

Connect the drain hose to a drain duct (with internal diameter of at least 1.6 inches) or place it for drainage in to a sink or a tub, ensuring that there are no kinks or bends. The free end must be at a height of 24"-40" from the floor. The hose can be held in place using the black plastic clamp on the upper part of the back panel.

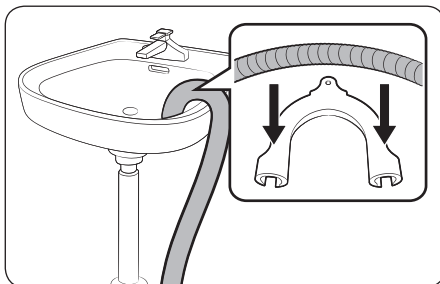

Fig. 10

Height difference between the installation location of the washing machine and the drainage point:  
Minimum 24", and Maximum 40".

- Attach water drain hose to hose guide.
- Hook the hose guide over the side or stand pipe (Fig.8).
- When the water is being drained, check that the water flow out of the hose is adequate.

## Dryer can be used in Ventless or Vented mode



Icon for Ventless



Icon for Vented

### VENTLESS (CONDENSING) DRY

#### Use dryer in Ventless Mode:

1. ENSURE METAL VENT COVER (1) IS INSTALLED OVER EXHAUST FAN AS SHOWN IN FIG.8
2. Power on the machine
3. Press "Dry Only" button to set the machine on drying cycle.
4. Hold Vented/Ventless button for 5 seconds
5.  symbol will appear on the screen which confirms that the machine is in Ventless mode.
6. Press START to run dryer in Ventless mode.

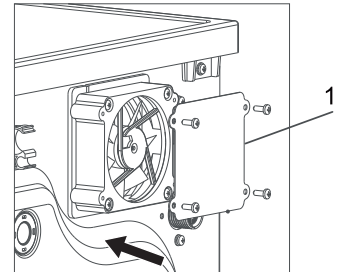



Fig. 11

*Ventless dry (condensing) uses cold water to dry the clothes. The cold water mixes with the hot air in a condensing chamber within the machine. Please ensure the cold water faucet is open during ventless dry mode.*

**Note: Slight condensation can occur at soap dispenser and will evaporate. This is a normal feature.**

### VENTED (HOT AIR) DRY

#### Use dryer in Vented mode:

1. ENSURE METAL VENT COVER OVER THE EXHAUST FAN IS REMOVED.
2. Press "Dry Only" button to set the machine on drying cycle.
3. Hold Vented/Ventless button for 5 seconds.
4.  symbol will appear on the screen which confirms that the machine is in vented mode.
5. Press START to run dryer in vented mode.

### Connecting the dryer vent duct

*For venting function the machine vents the moist hot air out of the unit and requires a vent hose (standard 4" diameter) to be installed.*

Vent hose adapter is provided along with the machine which needs to be installed on exhaust fan, with screws provided for vent cover.

To install the vent hose, attach the vent hose (2) onto the vent hose adapter (1) as shown in Fig.9

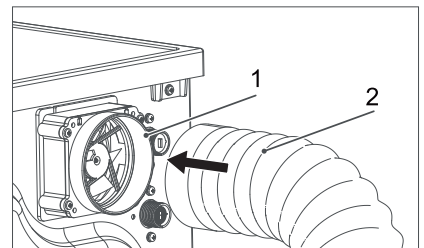

Fig. 12

#### INSTALLATION INSTRUCTIONS FOR EXHAUST



**IMPORTANT:** Installation and service must be performed by a qualified installer. Please have a qualified service agent install your dryer.

**NOTE:** The **WARNING** and **IMPORTANT** instructions appearing in his manual are not meant to cover all possible conditions and situations that may occur. It must be understood that common sense and being careful are factors that **CANNOT** be built into the Washer-Dryer. These factors **MUST BE** supplied by the persons installing, maintaining, or operating the dryer.

## EXHAUST REQUIREMENTS

**MAXIMUM LENGTH OF THE VENT HOSE IS 10 FEET WITH THE 0.5 AMPS ORIGINAL EXHAUST FAN. USING LONGER VENT HOSE MAY DAMAGE INTERNAL COMPONENTS. FOR LONGER VENT HOSE USE 1.5 AMPS EXHAUST FAN, WHICH IS AVAILABLE AS AN ACCESSORY.**

DUE TO RISK OF FIRE USE ONLY METALLIC DUCT (RIGID OR FLEXIBLE).

Never use flexible duct inside the dryer.

Do not terminate exhaust in a chimney, range hood, gas vent, floor or attic. The combination of lint and grease could create a fire hazard or damages.

Provide an access for inspection and cleaning the exhaust system at least once a year.

### EXHAUST SYSTEM CHECK LIST HOOD OR WALL CAP

Terminate in a manner to prevent back drain or entry of birds or other wildlife.

Termination should present minimal resistance to the exhaust air flow and should require little or no maintenance to prevent clogging.

Wall caps must be installed at least 12" above ground level or any other obstruction with the opening pointed down.

If roof vents or louvered plenums are used, they must be equivalent to a 4" dampened wall cap in regard to resistance to air flow. Prevention of back drafts and regular maintenance are required to prevent clogging.

### SEPARATION OF TURNS

Separate all turns by at least 3 feet (1 meter) of straight duct, including distance between last turn and dampened wall cap. If two turns must be closer than 3 feet (1 meter) deduct 10 feet (3 meters) from the maximum length.

### URNS OTHER THAN 90°

One turn of 45° or less may be ignored.

Two 45° turns should be treated as one 90°.

Each turn over 45° should be treated as one 90°.

For each 90°turn, deduct 33 feet (10 meters) from maximum length.

### SEALING OF JOINTS

All joints should be tight to avoid leaks. The male end of each section of duct must point away from the dryer.

Do not assemble the duct work with fasteners that extend into the duct. They will serve as a collection point for lint.

Duct joints can be made air and moisture-tight by wrapping the overlapped joints with duct tape.

### INSULATION

Duct work which runs through an unheated area or is near an air conditioning duct, should be insulated to reduce condensation and lint build up and be sloped down toward outdoors.

**NOTE:** Never install screen inside exhaust duct.

**WARNING: THIS MACHINE MUST BE EXHAUSTED OUTDOORS WHEN OPERATED IN THE VENTING MODE. THIS IS TO PREVENT LARGE AMOUNTS OF LINT AND MOISTURE FROM ACCUMULATING AND TO MAINTAIN DRYING EFFICIENCY.**

**ATTENTION: IN VENT DRY MODE, THE EXHAUST FAN AND EXHAUST DUCT SHOULD BE CLEANED ONCE A YEAR.**



## EXHAUST REQUIREMENTS FOR CANADA

Exhausting refers to removal of moist air from the drying compartment to the environment through an opening in the appliance housing.

- The appliance shall not be exhausted into a chimney, wall, ceiling, space, or concealed space of a building.
- Only rigid or flexible metal duct shall be used for exhausting.
- In Canada, only those foil-type ducts, if any, specifically identified for use with the appliance by the manufacturer shall be used.  
In the United States, only those foil-type flexible ducts, if any, specifically identified for use with the appliance by the manufacturer and that comply with the UL2158A, shall be used.
- In Canada, the exhaust duct shall be 102 mm in diameter.  
In the United States, the required exhaust duct diameter shall be 100 mm.
- The maximum duct length shall be 1.8 m (6 ft), and 1 bend.
- The total length of flexible metal duct shall not exceed 2.4 m.
- The duct shall not be assembled with screws or other fastening means that extend into the duct and catch lint.

## MOBILE HOME INSTALLATION

- The dryer must be exhausted to the outdoors with the termination securely fastened to the mobile home structure.
- The exhaust **must not** be terminated beneath the mobile home.
- Provisions must be made for the introduction of outside air into the dryer.  
The free air opening shall not be less than 12 sq. inches.
- The exhaust duct material **must be metal**.
- The dryer must be attached to the floor following instructions available from the dealer.
- Installation must comply with the current CAN / CSA Z240MH series Mobile Home Installation Codes.

## SPECIAL INSTALLATION REQUIREMENTS

### MINIMUM CLEARANCE OTHER THAN ALCOVE OR CLOSET INSTALLATION

Minimum clearances to combustible surfaces: 2" (5 cm) clearance both sides and 3" (7.5 cm) rear.

### BUILT-IN, RECESSED, CLOSET AND ALCOVE INSTALLATION

The Combo Washer-Dryer may be installed in a built-in, recessed area, closet or alcove.

The installation spacing is in inches and is the minimum acceptable.

Other installation must use the minimum dimension indicated.

Minimum clearance between dryer cabinet and adjustment walls are: 2" either side and 3" front and rear.

Minimum vertical space from floor to overhead cabinets, etc. is 52" (132 cm).

Closet door must be louvered or otherwise ventilated and must contain a minimum of 60 sq. in. of open area equally distributed. If this closet contains both washer and a dryer, doors must contain a minimum 120 sq. in. of open area equally distributed.

No other fuel-burning appliance shall be installed in the same closet with dryer.

★ Additional clearances for wall, door and floor molding may be required.

★ ★ Additional space is needed when an external exhaust elbow is used.

**NOTE:** If a door is installed that potentially encloses the unit while running, the door must allow for a minimum of 20 sq. in. of air free movement. There must also be a 1" additional space in front of the unit to the closed door and 1" from the back of the unit to the wall. Additional spacing should be considered for easy installation, servicing and compliance with all applicable local, state and federal codes.

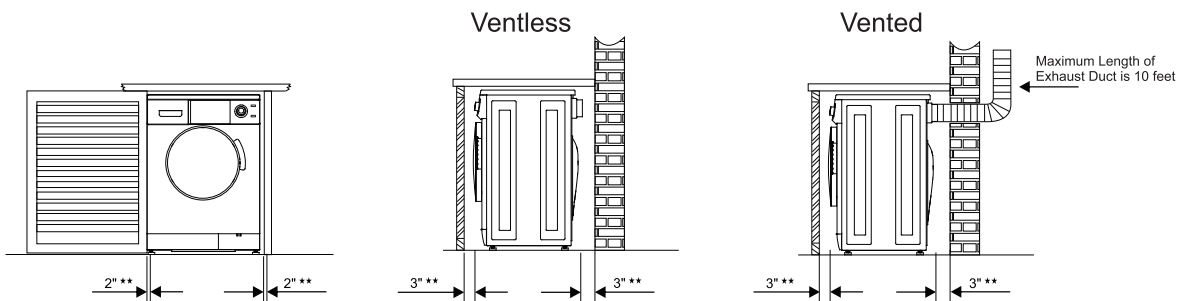

Fig. 13

### ADA COMPLIANCE

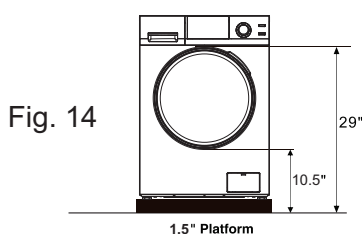

Fig. 14

Use 1.5" height platform to make the machine ADA compliant.

## PROGRAM SELECTION CHART

### 1. WASH & DRY, WASH ONLY, DRY ONLY

Wash Programs	Description of Load	Wash Features			Dry Features	
		Water Temp	Spin rpm	Duration	Max. Heat	Approx Time
1 - NORMAL	Mixed Cottons	Warm	1200	51 mins	1300W	90 mins
2 - Pre wash+Heavy	Thick Cottons (towels, jeans)	Cold + Hot	1400	75 mins	1300W	120 mins
3 - Heavy	Mixed Clothes (t-shirt, jeans)	Warm	1400	61 mins	1300W	120 mins
4 - ECO	Mixed Cottons	Cold	800	31 mins	1300W	80 mins
5 - Quick 20'	Cotton blends, light fabrics	Cold	1200	20 mins	1300W	80 mins
6 - Delicate	Silk, Polyester etc	Cold	800	36 mins	750W	80 mins
7 - Salt Wash	Mixed Cottons	Cold	800	36 mins	1300W	90 mins
8 - Quiet 60 dB	Mixed Cottons	Cold	800	31 mins	1300W	80 mins
9 - Allergen 131°	Bed sheets etc	Hot (131°F)	1200	59 mins	1300W	120 mins
10 - Sanitize 165°	Mixed Cottons	Hot (165°F)	1200	69 mins	1300W	120 mins
11 - PET Cycle	Mixed Cottons	Cold	1200	36 mins	1300W	30 mins
					750W	60 mins

### 2. DRY CYCLES

**Refresh 12** - 12 minutes cycle blowing hot air onto the clothes.

**Time Dry 60** - 60 minutes dry cycle.

### 3. OTHER CYCLES:

**Self clean** - 40 minutes cycle to clean the inner drum and tub of the machine.

**Drain** - 2 minutes cycle to drain out the residual water in the tub of the machine.

**Winterize** - 2 minutes cycle to winterize your appliance.

**PET Cycle** - For cleaning pet hair - Please see important instructions on page 18.

**Salt Wash** - 5 minute initial rinse before wash cycle begins to remove salt from clothing.

⚠ The total working time will vary with the laundry size, water pressure, water temperature and ambient temperature etc..

## PET Cycle

Before loading clothes and sheets into the appliance, remove as much pet hair as possible in order to prevent buildup and clogging of the drain pump. Wipe the surface of clothes and sheets with a lint roller or a damp rubber glove to easily remove pet hair.

After the end of the wash cycle, run a quick wash cycle without clothes. After the cycle ends, wipe down the drum with a damp cloth to collect any pet hair on the drum surface.

## OPERATING INSTRUCTIONS

1. Ensure the Combo Washer⊕Dryer is turned off. (Power Indicator light should be off).
2. Separate clothes by type, color and degree of soiling.
3. For small items use a mesh bag.
4. Load clothes of the selected type loosely into the drum.  
If you are using Wash Only cycle, you can fill the drum.  
If you are using Wash + Dry cycle, please do not load clothes more than 2/3 full.
5. Close the Washer⊕Dryer door. You will hear a click when it is correctly closed.  
Use Front Load detergent, as per direction.  
Add detergent to Dispenser A.  
You can add fabric softener in Dispenser B & pre-wash detergent and bleach in Dispenser C (Fig. 15).

### Detergent Dispenser

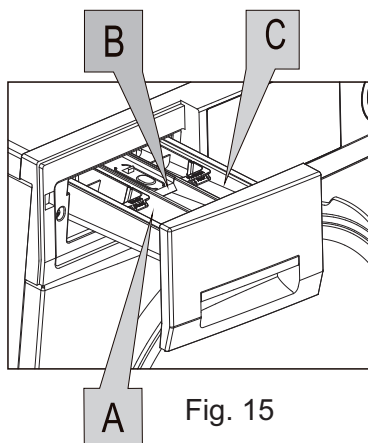

Dispenser A:  
**Detergent for main wash**

Dispenser B:  
**Fabric softener**

Dispenser C:  
**Detergent for pre-wash and bleach**

**The blue cups are only for liquid detergent.  
Please do not add powder in these cups.**

Note: concentrated fabric softener must be diluted with a little water before being poured into the dispenser  
(This prevents the overflow siphon from getting blocked)

Your washer/combo is designed to use a high efficiency (HE) detergent, which reduces or eliminates suds and results in more efficient washing.



## WINTERIZING



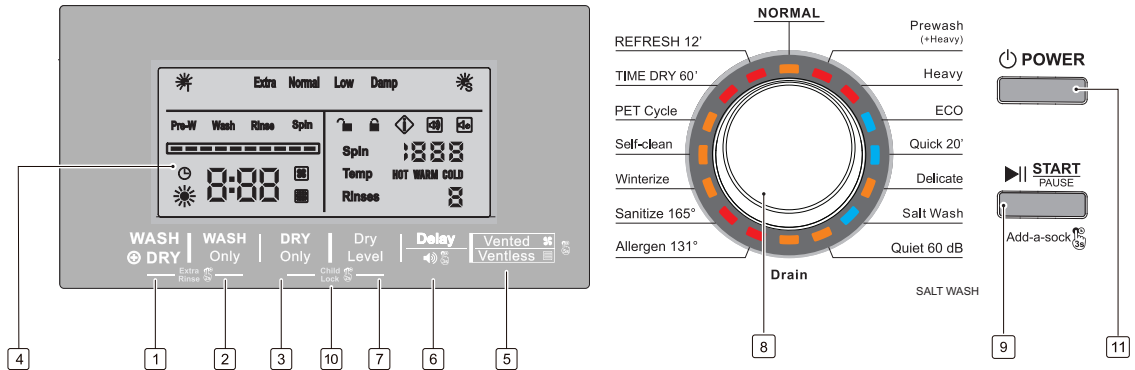

### How to winterize for cold weather

1. Pour 2 cups of RV type Antifreeze in soap dispenser.
2. Select WINTERIZE cycle on knob and press START. Machine will Rinse & Spin.
3. Open Coin trap once cycle is finished and drain out reaming water.
4. Shut off water at both faucets and disconnect water inlet hoses from faucets and drain.

## Control Panel



### Buttons Introduction

- 1 Wash ⊕ Dry To select Wash & Dry cycle together.
- 2 Wash Only To select Wash cycle only. For extra rinse, press and hold 1 + 2 together.
- 3 Dry Only To select Dry cycle only.
- 4 Color LED Display To display the selected program, such as the water selection, spin speed, remaining time, rinse times, water level and error messages. (See page 18 for details)
- 5 Vented / Ventless selection button Press this selection button for 5 seconds to select either the Vented dry mode or the Ventless dry mode. The default condition is the Ventless mode. The symbol  will be displayed if you are using the Ventless dry mode and symbol  will be displayed for Vented dry mode.
- 6 Delay and Chime (🔊) button To delay the start of the wash cycle, touch this button to select the delay time from 1 to 24 hours. Each time the Delay button is pressed, the time increases in one-hour increments. The delay time will show on the Display Panel. Then press Start and the cycle will start after the selected delay time has elapsed.  
  
To turn the chime on  or chime off , wait until after the wash cycle has started and then press and hold the button for 5 seconds. The chime icon will illuminate showing the chime on or off selection.
- 7 Dry Level button Press this button to select the dry level for a Sensor Dry cycle. The default is Normal and you can select Extra, Low or Damp Dry.
- 8 Program Dial Turn the dial to point to one of the 13 programs depending on the load.
- 9 Start/Pause button Press this button to start or stop the selected wash program, or to view the program during a cycle.
- 10 Child Lock In order to deactivate function to the controls, to prevent altering cycle, press and hold Dry only and Dry level buttons for 5 seconds
- 11 Power Press this button to turn the machine on.

If a sensor dry cycle is selected, the symbol  will be displayed.

If a time dry cycle is selected, the symbol  will be displayed.

## Display Panel Symbols

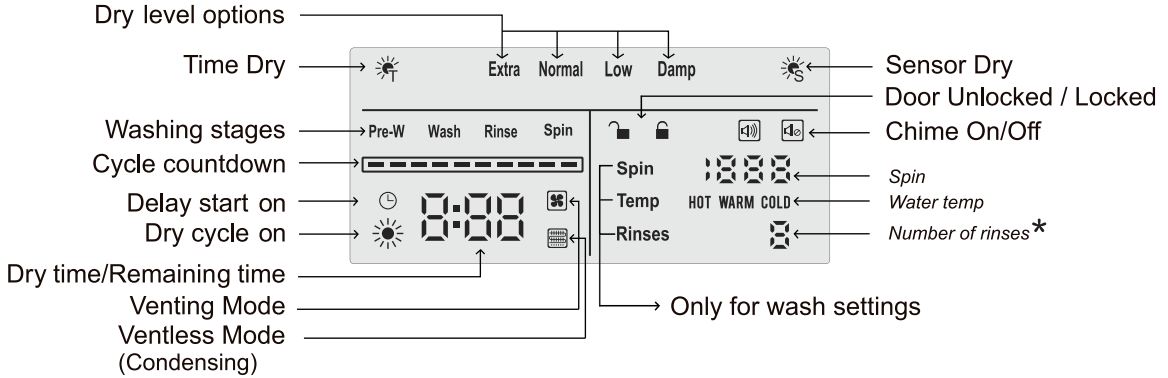

\* An extra rinse can be added by pressing “Wash+Dry” and “Wash Only” at the same time. An Extra rinse and 9 minutes will be added to the cycle.

### A. How to run WASH + DRY Cycle

1. Press POWER button
2. Press START

Default cycle is NORMAL - If required you can change to desired washing cycle based on type of clothes by rotating the Program Dial knob.

### B. How to run WASH Only Cycle

1. Press POWER button
2. Press WASH Only button
3. Press START

Default cycle is NORMAL - If required you can change to desired washing cycle based on type of clothes by rotating the Program Dial knob.

### C. How to run DRY Only Cycle

1. Press POWER button
2. Press DRY Only button
3. Press START

Default cycle is NORMAL and Sensor Dry - You can select Damp, Low or Extra for the desired dry level. You can also select Time Dry for 60 minutes.

4. At the end of the DRY cycle, if the clothes are not completely dry or if the clothes have been in the drum for some time, you can press the Refresh button to dry the clothes and prevent wrinkles.

## Add-a-sock Feature

The wash program can be stopped at any time to add forgotten items to the laundry.

- Press START/PAUSE for 5 seconds.
- Door will open 2 mins after draining water so that it does not overflow.
- Load clothes. Close door.
- Press START The cycle will continue from the point it stopped

## How to stop the wash cycle

- The wash program can be stopped at any time.
- Press START/PAUSE for 5 seconds
- Press POWER button for 3 seconds to turn off the machine

## How to stop the dry cycle



- Press POWER button for 3 seconds to turn off the machine

## How to turn on the display in energy saving mode?

- Machine display gets turned off automatically during operations to save energy.
- Press any button to turn on display during this energy saving mode

---

## Door lock function

Pressing the START button  will lock the door  → . The wash cycle will start and will continue until the whole program is completed. The door will be locked and cannot be opened until the wash cycle ends. In a few minutes after the cycle ends, the door lock icon will change from locked to unlocked and then you can open the door easily.

Please do not try to force the door open. **Breakage of the door handle is not covered by warranty.**

## USEFUL TIPS

### Denim Alert:

Some overalls have straps with hooks that can damage the drum of your washing machine or other garments during the wash. To minimize the risk, place hooks in the pocket and fasten with safety pins.

### Vacation:

It is recommended that you should unplug the machine from the socket and turn off the water supply. Leave the door ajar to allow air circulation to the drum and the door gasket area. This will prevent unpleasant odors.

## MAINTENANCE

Your Washer-Dryer has been designed to operate with easy maintenance.

Follow these simple maintenance procedures to obtain optimum performance:

1. Ensure that your machine was installed according to the correct installation procedures detailed in this Manual.
2. Do not use solvents either to clean the machine or to wash clothes.
3. Keep the inside of the detergent dispenser clean.

### Cleaning the coin trap

- Switch off the Washer -Dryer
  - Open the service flap. (bottom right corner) Fig.16
  - Carefully unscrew the coin-trap cover. **Warning: Some residual water will flow out. (Approx. 1 Cup)** Fig.17
  - Remove foreign objects/fluff from inside and clean the interior. Fig.18
  - The pump impeller wheel is located behind the water filter, must be able to rotate. Remove detergent residue and fluff from the pump cover thread and pump housing.
  - Insert the coin-trap cover and screw tight. Fig.19
- Insert and close the service flap.

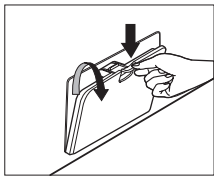

Fig. 16

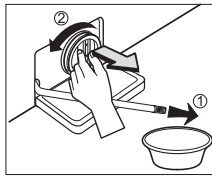

Fig. 17

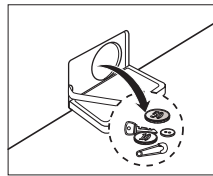

Fig. 18

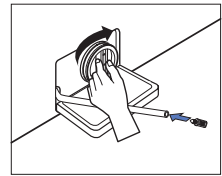

Fig. 19

### Cleaning the Detergent drawers and Recess

- Press release lever on the inside of the drawer and pull it out. Fig. 20
- Remove the cap from the Fabric Softener compartment.
- Wash all of the parts under running water.
- Clean the drawer recess with a small brush. Fig. 21, Fig. 22
- Reinsert the cap (Pushing it firmly into place).
- Push the drawer back into place.
- Run a rinse program without any laundry in the drum.

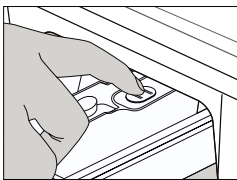

Fig. 20

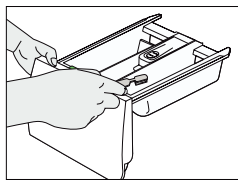

Fig. 21

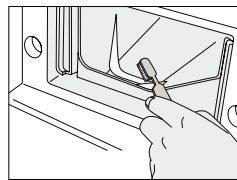

Fig. 22

### Cleaning the exhaust fan and duct

If Vent Dry mode is used, clean the exhaust fan and exhaust duct at least once a year to prevent lint build-up.

### PET Cycle - Maintenance

If the PET Cycle is used, it is important to run a quick wash cycle without clothes following every load. After the cycle ends, wipe down the drum with a damp cloth to collect any pet hair on the drum surface. The lint filter should also be cleaned more frequently.



## TROUBLESHOOTING

In most cases, when your Washer⊕Dryer fails to work, the problems arising can be easily solved without having to call for a technician. Before calling for assistance, always check these points.

### **Does not start**

- Plug correctly inserted into the socket?
- Electricity in the house?
- Door closed properly?
- Start button pressed?
- Power button pressed?
- Washer knob in the correct position for the cycle to start?
- Do any other devices work on that particular socket?

### **Does not fill with water**

- Hose correctly connected to the faucet?
- Water supply turned on?
- Sufficient water pressure?
- Faucet filter clean?
- Inlet hose kinked?

### **Continuously fills and drains water**

- Is the drain hose positioned too low?
- Check that the inlet hose is not connected at a height more than 4" above the floor.

### **Does not drain or spin**

- Does selected program incorporate water draining?
- Drain pump clogged?
- Drain hose kinked?
- Coin trap clean?

### **There are too many suds in the drum**

- Is Front loading detergent being used? It is recommended to use Front Load detergent
- Is the correct amount of detergent being used?

### **Vibrates during the spin cycle**

- Have all shipping bolts been removed during installation?
- Machine levelled correctly?
- Is there enough space between the machine and adjacent units?
- Is the machine loaded evenly?
- Is the machine installed on carpet or on a wooden floor?

### **Leaks**

- Is the metal ring of the inlet hose properly attached?
- Is the detergent dispenser obstructed?
- Is the drain hose inserted correctly into the drain?

### **Not drying**

- Is the dryer button correctly pressed for the drying cycle?
- Is drying cycle selected (Time Dry/Sensor Dry)?

### **Not drying efficiently**

- Is the end of the drain hose under water?
- Is the drain pump obstructed?
- Is the drum overloaded?
- Is the cold water faucet open?
- Is fabric softener being used?

### **Condensation at soap dispenser**

- Slight condensation can occur at soap dispenser and will evaporate. This is normal.

## ERROR CODES

Code	Description	Component
<b>E1</b>	Door open	Door Switch
<b>E2</b>	Drain failure	Drain Pump
<b>E3</b>	Water inlet failure	Inlet Valves
<b>E4</b>	Water overflow	Pressure Switch
<b>E5</b>	Motor failure	Motor +Electronic Module
<b>E7</b>	Washing heater failure	Washing heater
<b>E8</b>	Dryer Malfunction	Temp. sensor (@rear-bottom of tub)
<b>E9</b>	Dryer Malfunction	Temp. sensor (@front of heater housing)
<b>E10</b>	Water level failure	Water level sensor
<b>E11</b>	Dryer Malfunction	Temp. sensor (near the blow fan motor)
<b>E12</b>	Dryer Malfunction	Fan Motor
<b>E13</b>	Dryer Malfunction	Drying heater
<b>E16</b>	Communication between display & electronic module	Communication Cable

**To Order parts : [www.ApplianceDesk.com/Parts](http://www.ApplianceDesk.com/Parts)**