

## Care and Maintenance

Dust with a soft, dry cloth. Do not use abrasive cleaner. To clean mirror, spray a small amount of glass cleaner onto a lint-free cloth and wipe mirror clean.

## Notice









\* Please make sure that you have all parts indicated before you begin assembly of this item

\* This item should be assembled on a soft surface to prevent scratching the finish during assembly

\* This item may require periodic tightening

Product Dimensions: 22" W X 22" D X 35 3/8" H

## Part List and Hardware List

Piece	Description	Picture	Quantity
A	top shelf		1X
B	thread rod		4X
C	long leg		4X
D	middle shelf		1X
E	middle leg		4X
F	bottom shelf		1X
G	short leg		4X
H	wheel		4 X
I	mirror		3X

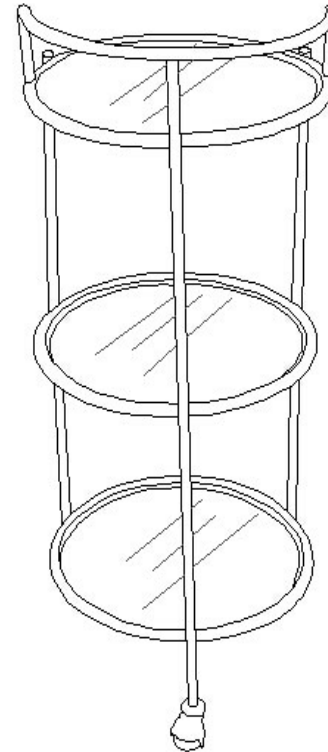

## Preparation

Before beginning assembly of product, make sure all parts are present. Compare parts with package contents list and hardware contents list.

If any part is missing or damaged, do not attempt to assemble the product.

Estimated Assembly Time: 10 minutes.

Tools Required for Assembly (included): Assembly Fininal

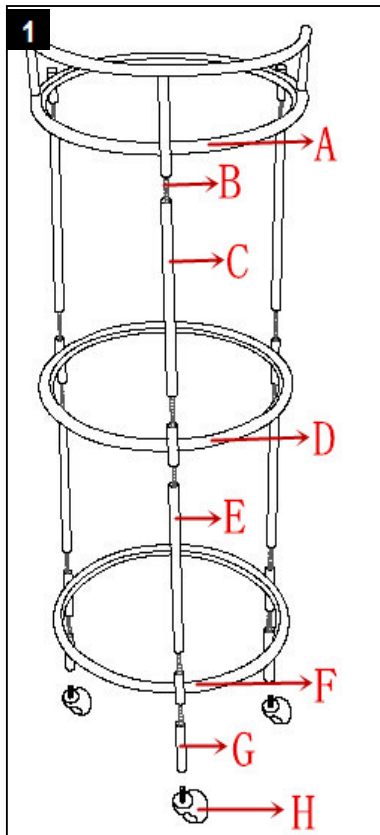

Step 1

Assemble the Top shelf(A) Long leg(C)  
Middle shelf(D) Middle leg(E) Bottom shelf(F)  
Short leg(G) and Wheel(H) together using  
Thread rod(B).

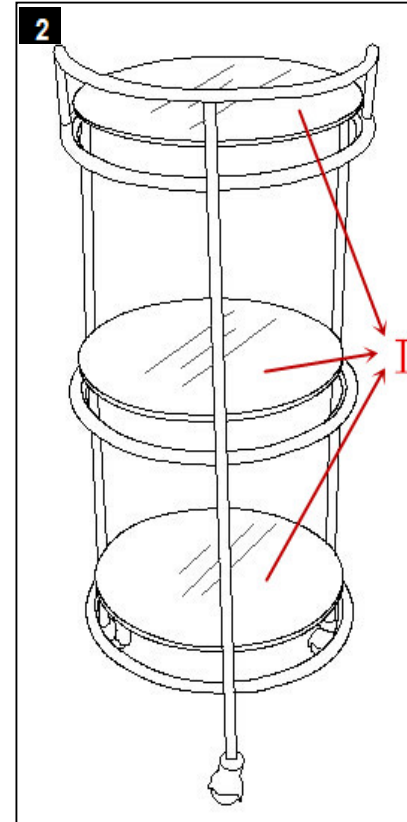

Step 2

Carefully place the Mirror( I)