

ASSEMBLY INSTRUCTION

SKU# 97553

Before beginning

- Unpack all parts and hardware to ensure you have all needed components for assembly
- Read this guide cover before beginning assembly .
- Assemble this item on a soft surface such as carpet to protect finish.
- Proper assembly of this item requires 2 person & 20 minutes to assemble.

CARE INSTRUCTIONS

Wipe with a soft and dry cloth. To protect finish, avoid the use of chemicals and household cleaners. Any liquid in the table should be cleaned up immediately with a damp cloth.

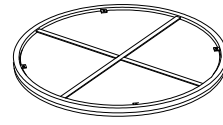

TOP

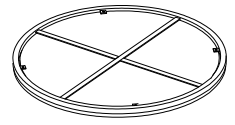

BOTTOM

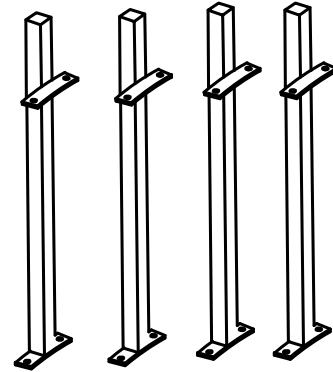

LEG

HOW TO ASSEMBLE





STEP-1 Place the end table top upside on rug and match marking A with A and B with B and C with C and D with D respectively.

STEP-2 Insert allen bolt J with spring washer L and flat washer K then tighten with allen key I and loose allen bolt.

STEP-3 Match marking E with E and F with F and G with G and H with H respectively and holding bottom top by one person.

STEP-2 Insert allen bolt J with spring washer L and flat washer K then tighten with allen key I.

STEP-5 Turn the end table upside down, end table ready to use.

| No. | Sketch | Description. | Size (IN) | Qty. | Ext. |
|-----|--|---------------|------------|------|------|
| I |  | ALLEN KEY | 0.19" | 1 | 0 |
| J |  | ALLEN BOLT | 0.31X0.78" | 08 | 1 |
| K |  | WASHER | 0.35X0.78" | 08 | 1 |
| L |  | SPRING WASHER | 0.35X0.5" | 08 | 1 |

STEP- 1

Tip for leveling of product:
When the product rests on an uneven floor surface
it will appear to be unbalanced. To aid in leveling, try
adjusting the levelers on the bottom of each foot.

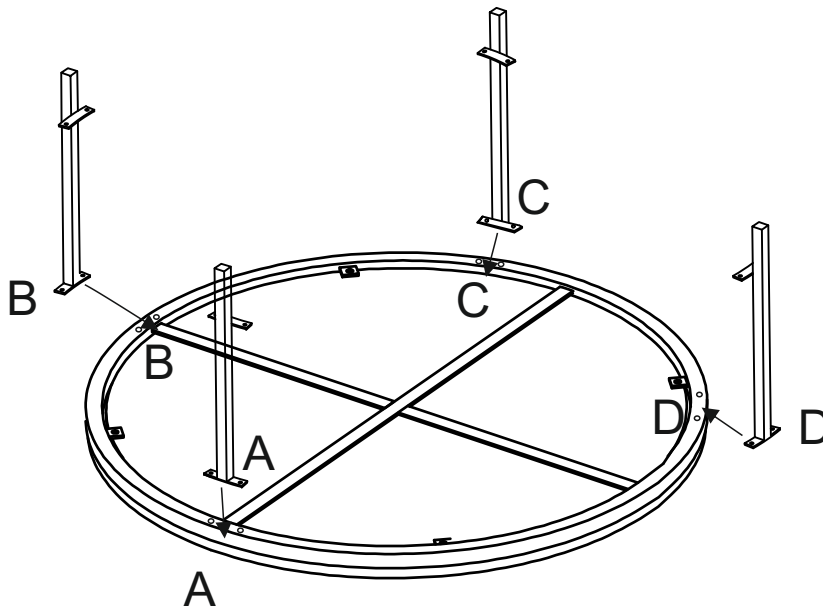
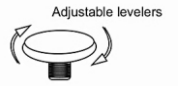

STEP- 2

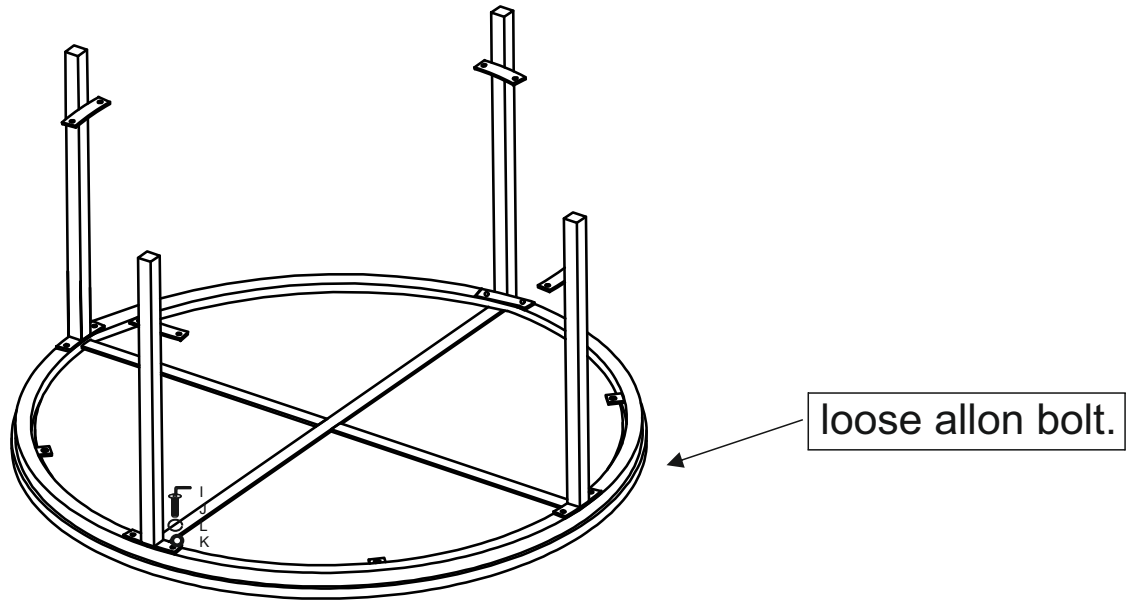

STEP- 3

