

Pure & Easy



# **ASSEMBLY INSTRUCTIONS**

# NOTICE

IMPORTANT, RETAIN FOR FUTURE REFERENCE: READ CAREFULLY  
WICHTIG, FÜR SPÄTERE NACHSCHLAGE AUFBEWAHREN: SORGFÄLTIG LESEN  
IMPORTANTE, GUARDAR PARA REFERENCIA FUTURA: LEER ATENTAMENTE  
IMPORTANTE, CONSERVARE PER RIFERIMENTI FUTURI: LEGGERE ATTENTAMENTE  
IMPORTANT, À CONSERVER POUR RÉFÉRENCE FUTURE : LIRE ATTENTIVEMENT

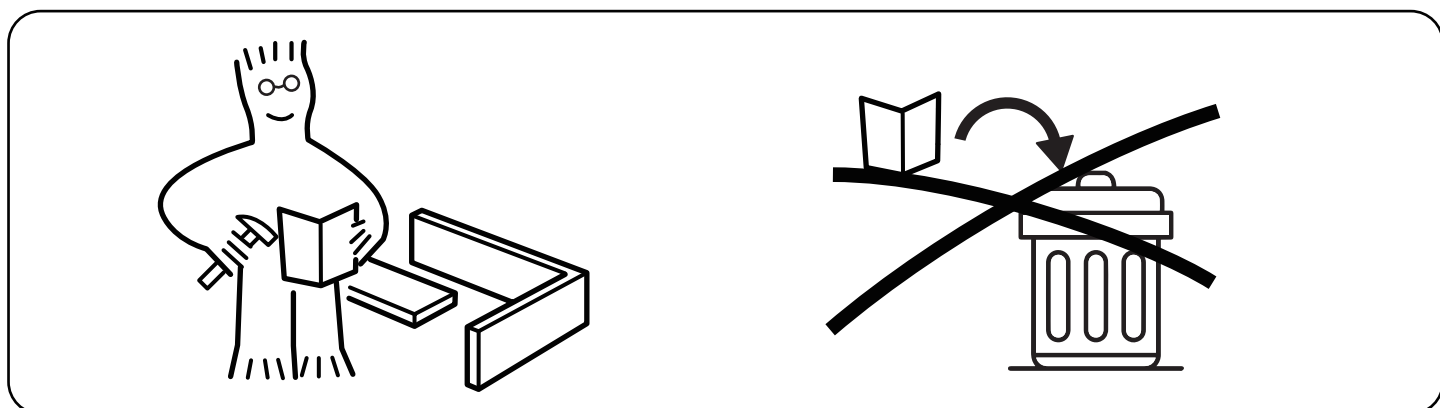

Assemble on a flat and solid surface. To avoid the unstable surface affecting the overall frame stability during installation.

Montieren Sie auf einer ebenen und festen Oberfläche. Um zu verhindern, dass eine unebene Oberfläche während der Montage die Gesamtrahmen-Stabilität beeinträchtigt.

Ensamblar en una superficie plana y sólida. Afin d'éviter que la surface inégale n'affecte la stabilité générale du cadre lors de l'installation.

Assemblare su una superficie piana e solida. Per evitare che una superficie irregolare influisca sulla stabilità complessiva della struttura durante l'installazione.

Assemble sur une surface plate et solide. Para evitar que la instalación en una superficie irregular afecte la estabilidad general del marco.

Professional installation is highly recommended.  
Eine professionelle Installation wird dringend empfohlen.  
Une installation professionnelle est fortement recommandée.  
Si raccomanda vivamente l'installazione professionale.  
Se recomienda altamente la instalación profesional.



Periodically Check That All Components Are Tightly Secured.  
Überprüfen Sie Regelmäßig, Dass Alle Komponenten Fest Gesichert Sind.  
Vérifiez Périodiquement Que Tous Les Composants Sont Bien Fixés.  
Controllare Periodicamente Che Tutti I Componenti Siano Ben Fissati.  
Verifique Periódicamente Que Todos Los Componentes Estén Bien Asegurados.

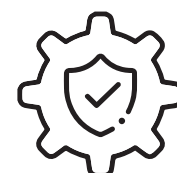

It is recommended that multiple people assemble this product.  
Es wird empfohlen, dass mehrere Personen dieses Produkt zusammenbauen.  
Il est recommandé que plusieurs personnes assemblent ce produit.  
Si raccomanda che più persone assemblino questo prodotto.  
Se recomienda que varias personas ensambren este producto.

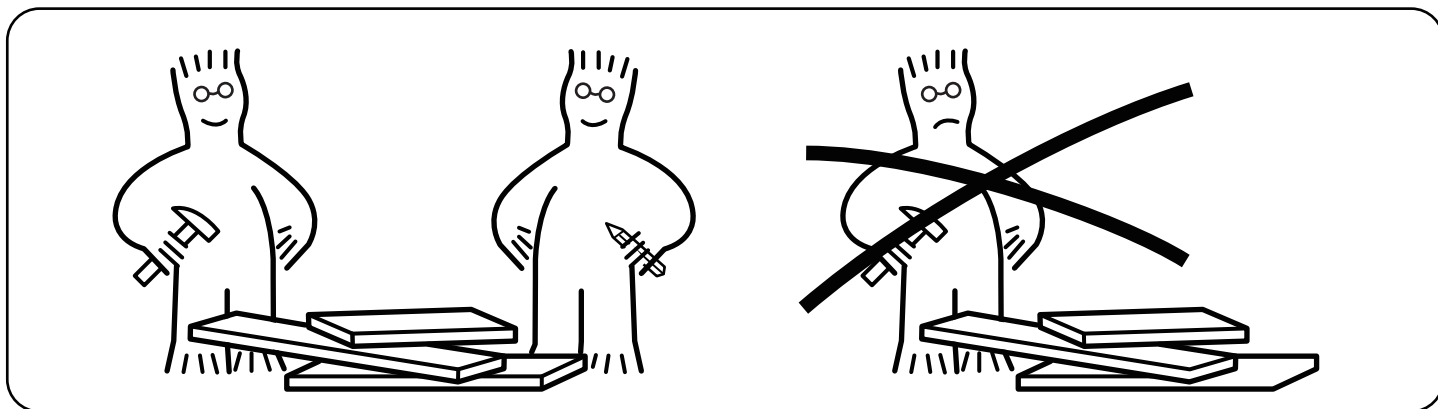







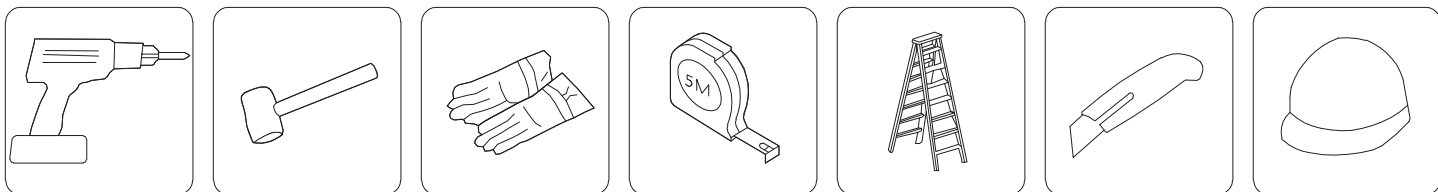





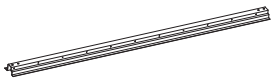

Please contact us if parts of your furniture are missing.  
Bitte kontaktieren Sie uns, wenn Teile Ihrer Möbel fehlen.  
Por favor contáctenos si faltan piezas de sus muebles.  
Si prega di contattarci se mancano parti dei vostri mobili.  
Veuillez nous contacter si des pièces de vos meubles manquent.



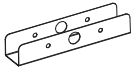

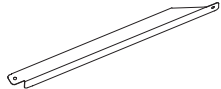
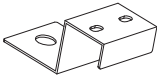
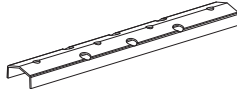
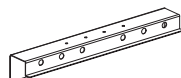

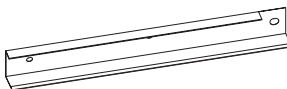
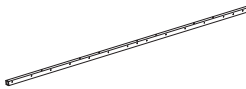
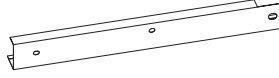
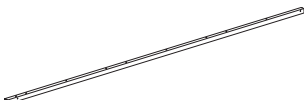



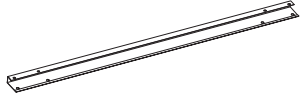
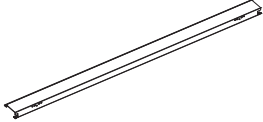
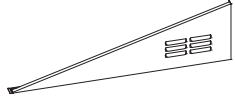
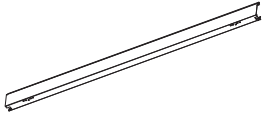

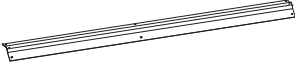

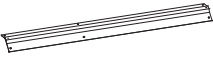
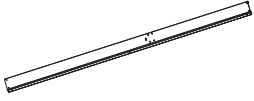
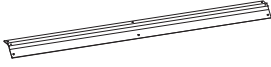









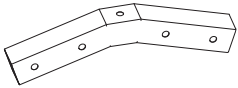



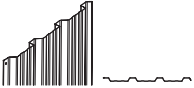



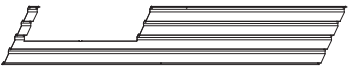

Please have the following auxiliary tools ready:  
Bitte halten Sie die folgenden Hilfswerkzeuge bereit:  
Veuillez préparer les outils auxiliaires suivants :  
Si prega di preparare i seguenti strumenti ausiliari:  
Por favor, tenga listos los siguientes herramientas auxiliares:



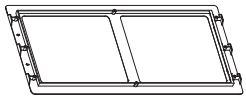
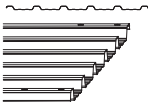
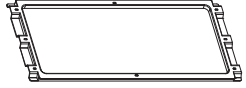
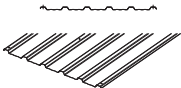







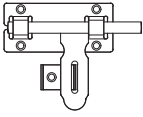

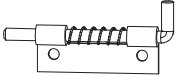
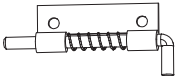

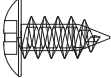
# PARTS

Item no.	Reference Image	Qty.	Item no.	Reference Image	Qty.
1L		X1	7L		X2
1R		X1	7R		X2
2L		X2	8L		X1
2R		X2	8R		X1
3L		X1	10		X4
3R		X1	10F		X2
4		X4	11A		X1
4B		X4	11C		X1
5		X4	11F		X2
6L		X1	11B		X2
6R		X1	15		X4

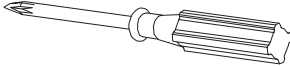
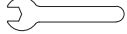
Item no.	Reference Image	Qty.	Item no.	Reference Image	Qty.
16		X2	21		X4
17L		X1	21L		X2
17R		X1	21R		X2
18B		X1	22		X1
18		X1	23		X1
18F		X1	9Y		X2
19B		X1	36		X1
19F		X1	58A		X2
19L		X1	59		X2
19R		X1	61		X2
20		X4	62		X1

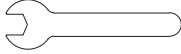
Item no.	Reference Image	Qty.	Item no.	Reference Image	Qty.
W1		X4	F4		X4
W3		X2	F5		X2
W5		X16	F7		X136
C3		X1	F8		X8
C4		X1	F9		X2
W7		X4	F10		X2
W12		X6	F12		X2
W15		X8	F13		X2
M1		X2	F14		X2
C		X4	F18		X1
F		X4	S1		X1

Item no.	Reference Image	Qty.
S2		X1
S3		X1
S4	 M4X10mm	X422
S5L		X1
S5R		X1
S6		X63
S6A		X10
S7		X67
S8		X10

Item no.	Reference Image	Qty.
S9		X4
S12		X1
S15		X1
S34		X4
S35		X1
Q14		X10
Q17		X18
Q20		X18
Q36		X7

# EXPLODED VIEW

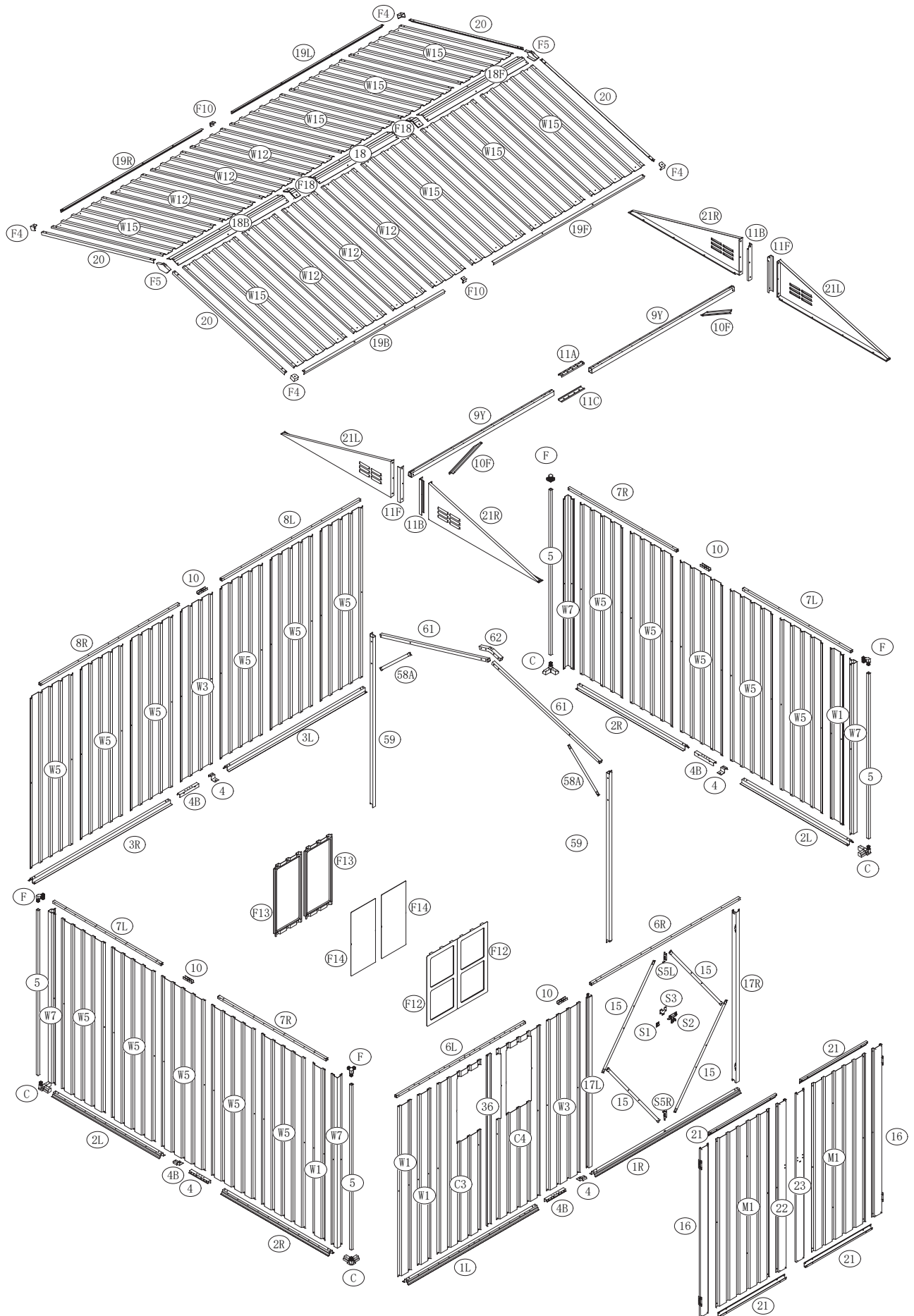

# ASSEMBLY

# 1



1L 1pc



1R 1pc



4 1pc

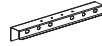

4B 1pc



S4 4pcs

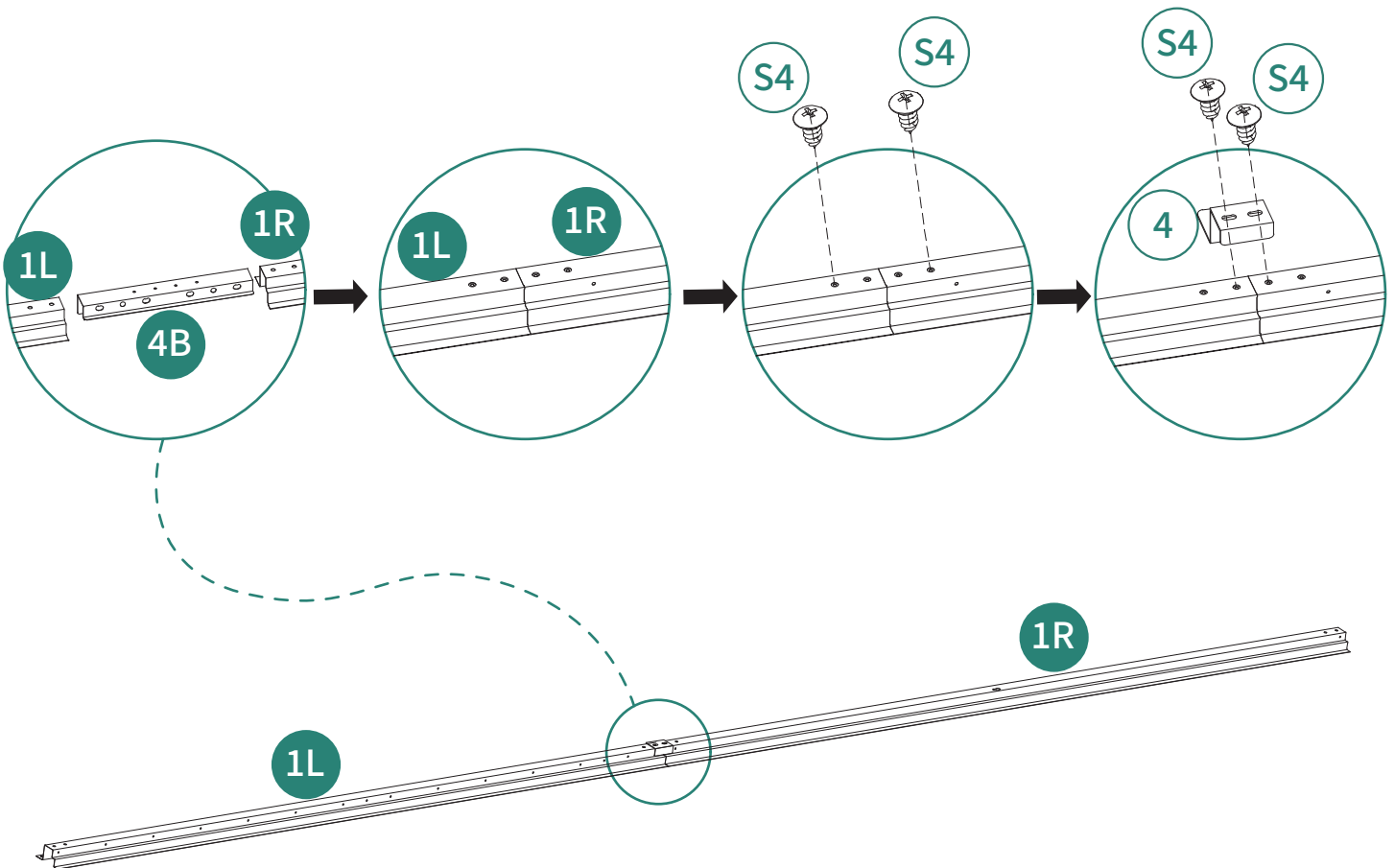

**2**  
**X2**

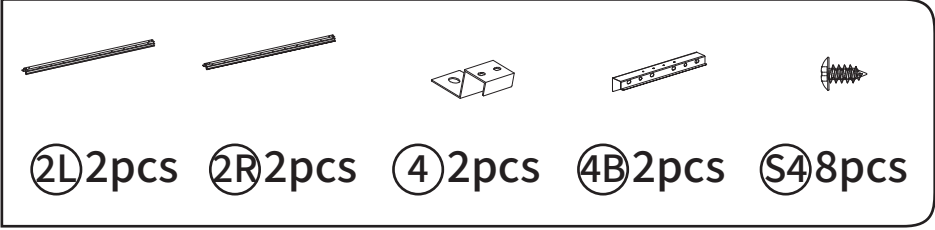

②L 2pcs   ②R 2pcs   ④ 2pcs   ④B 2pcs   ④S4 8pcs

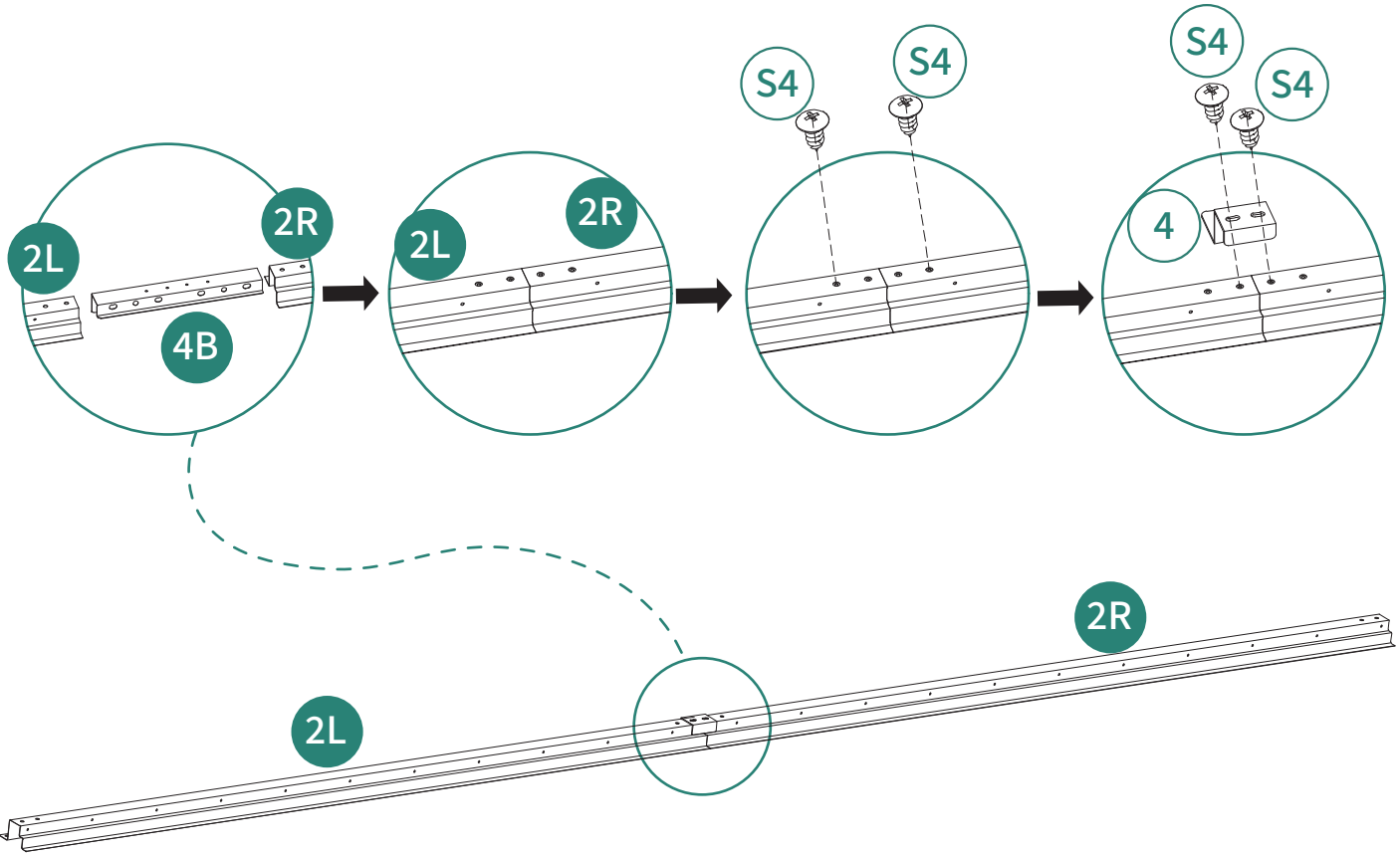

# 3



3L 1pc



3R 1pc



4 1pc



4B 1pc



S4 4pcs

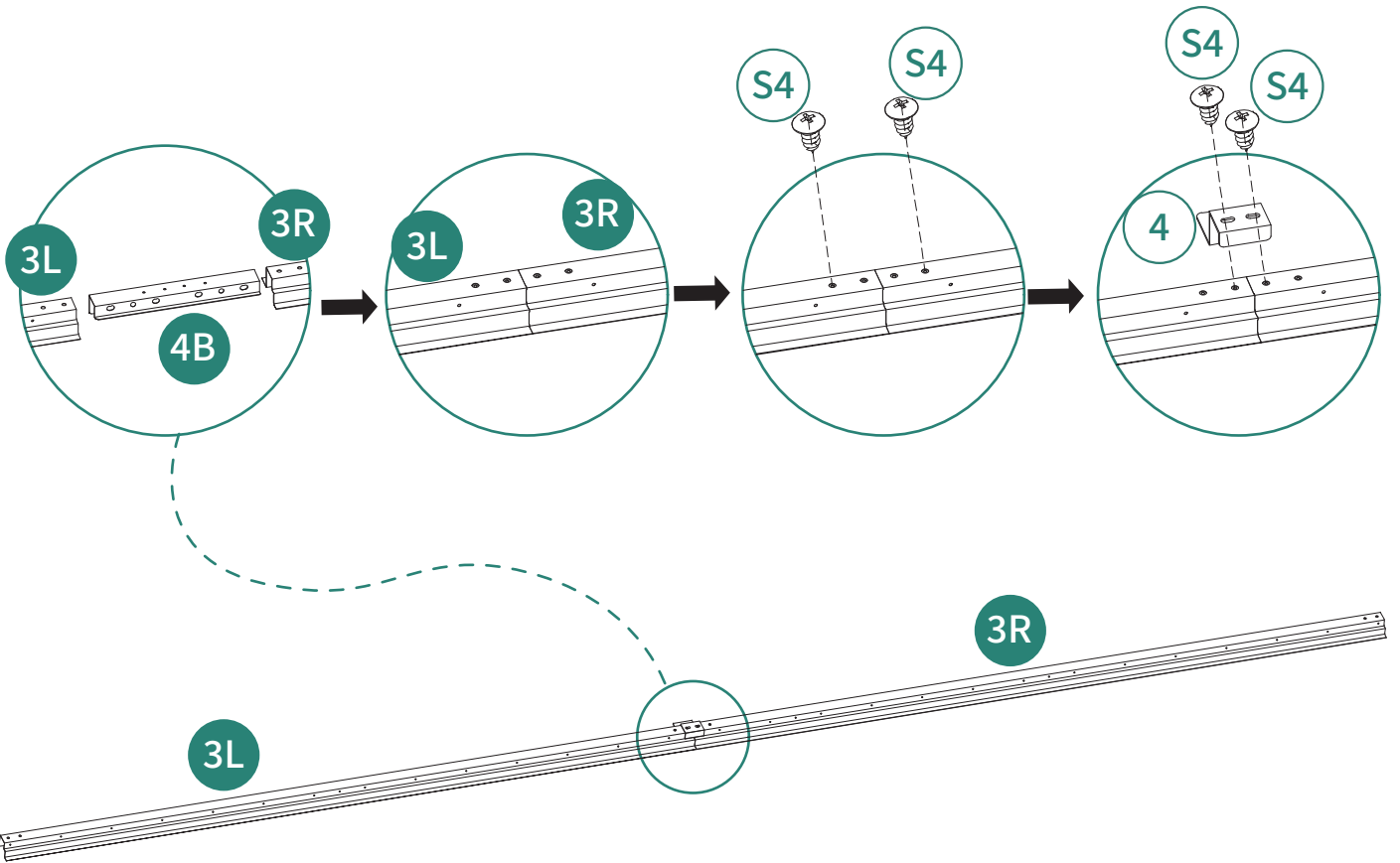

4



ⓐ4pcs Ⓢ416pcs

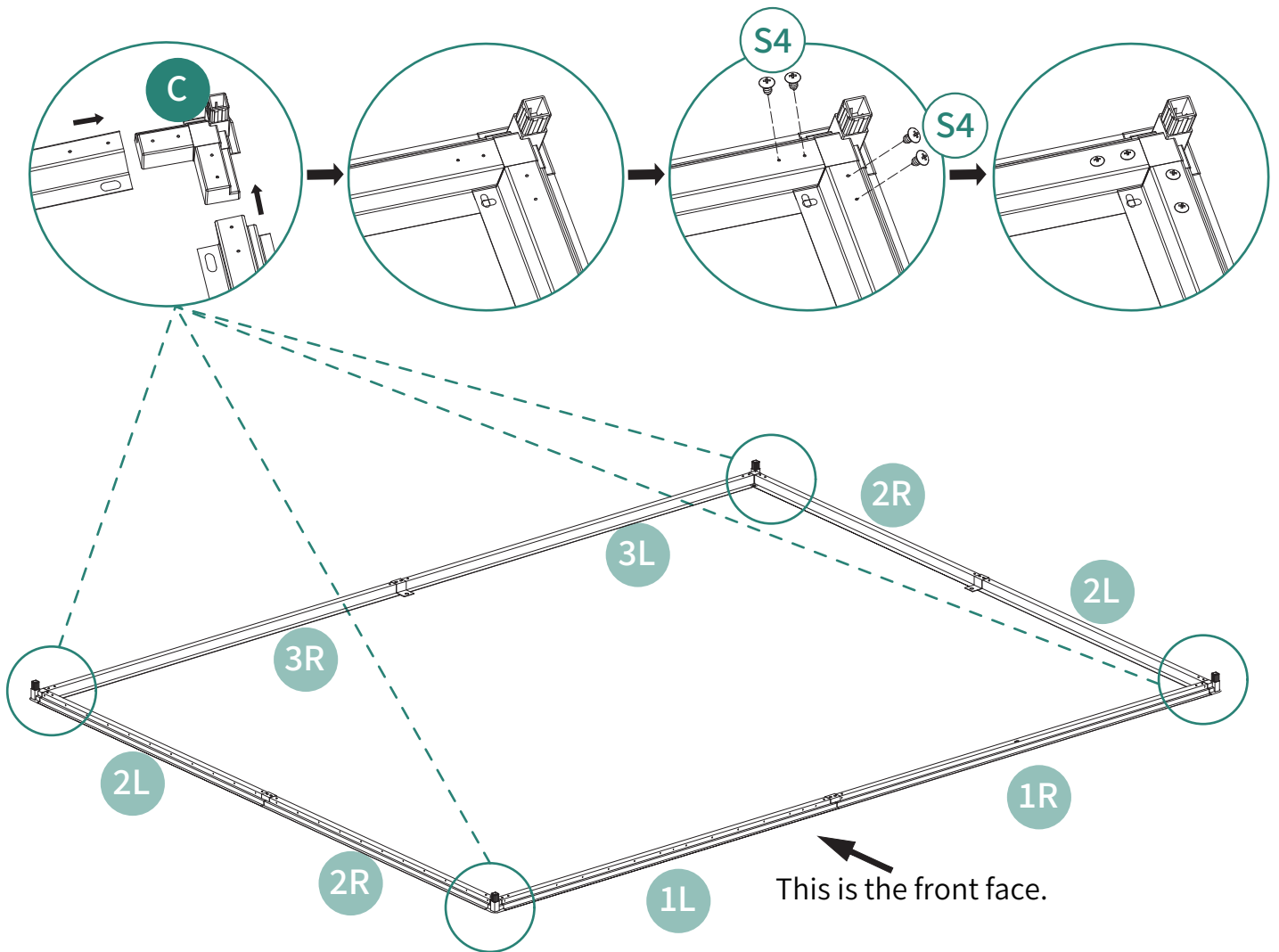

**5**



⑤ 4pcs

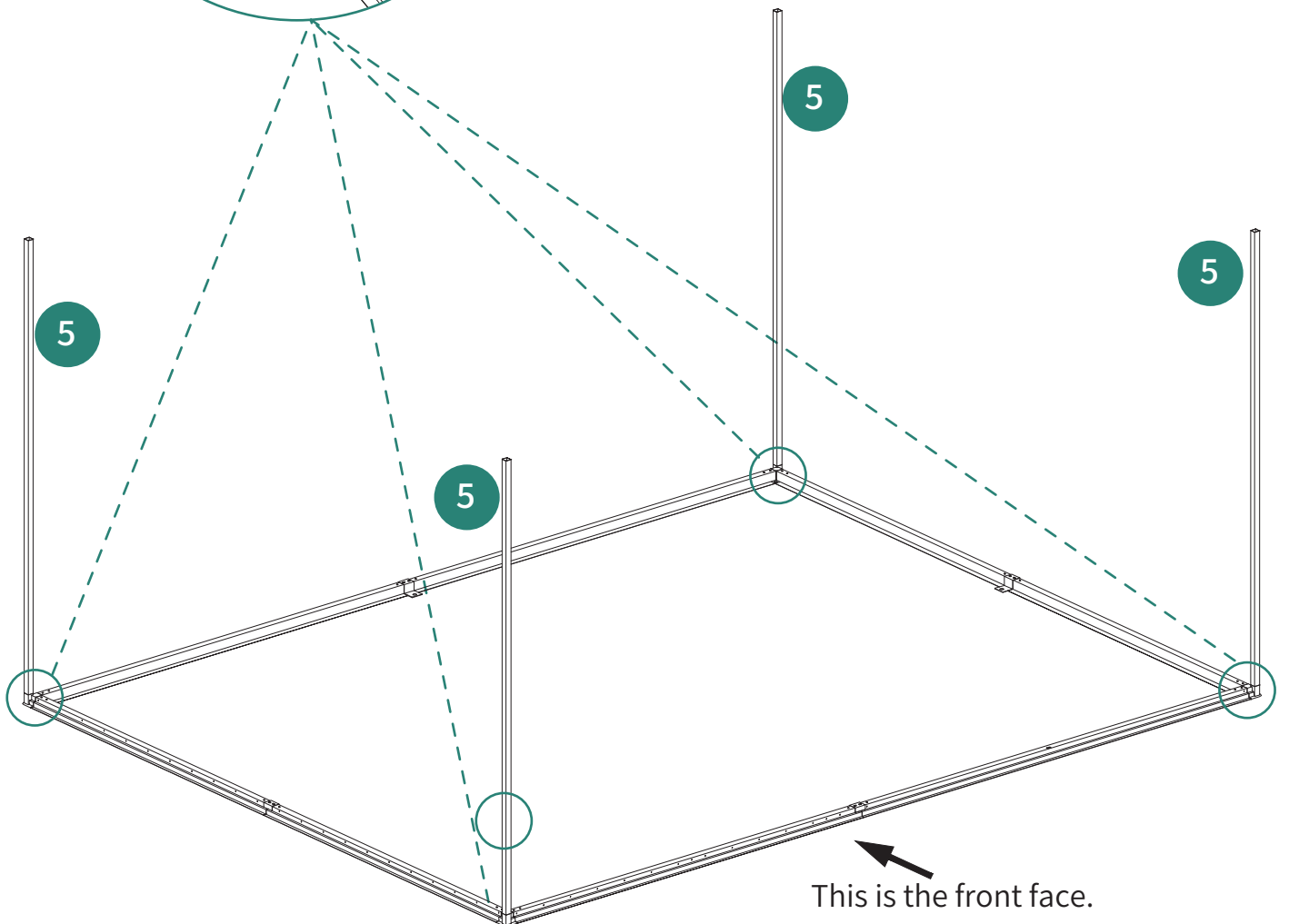
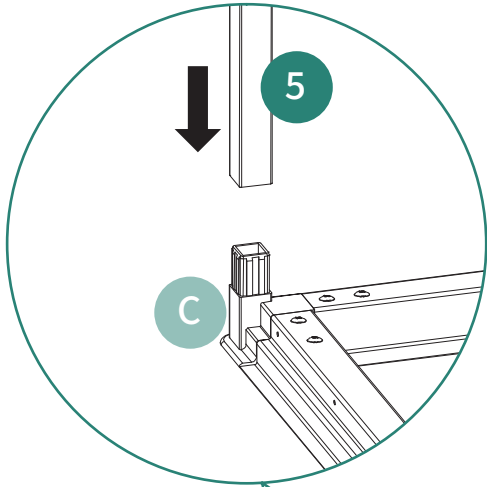

6



6L 1pc



6R 1pc



10 1pc



S4 4pcs

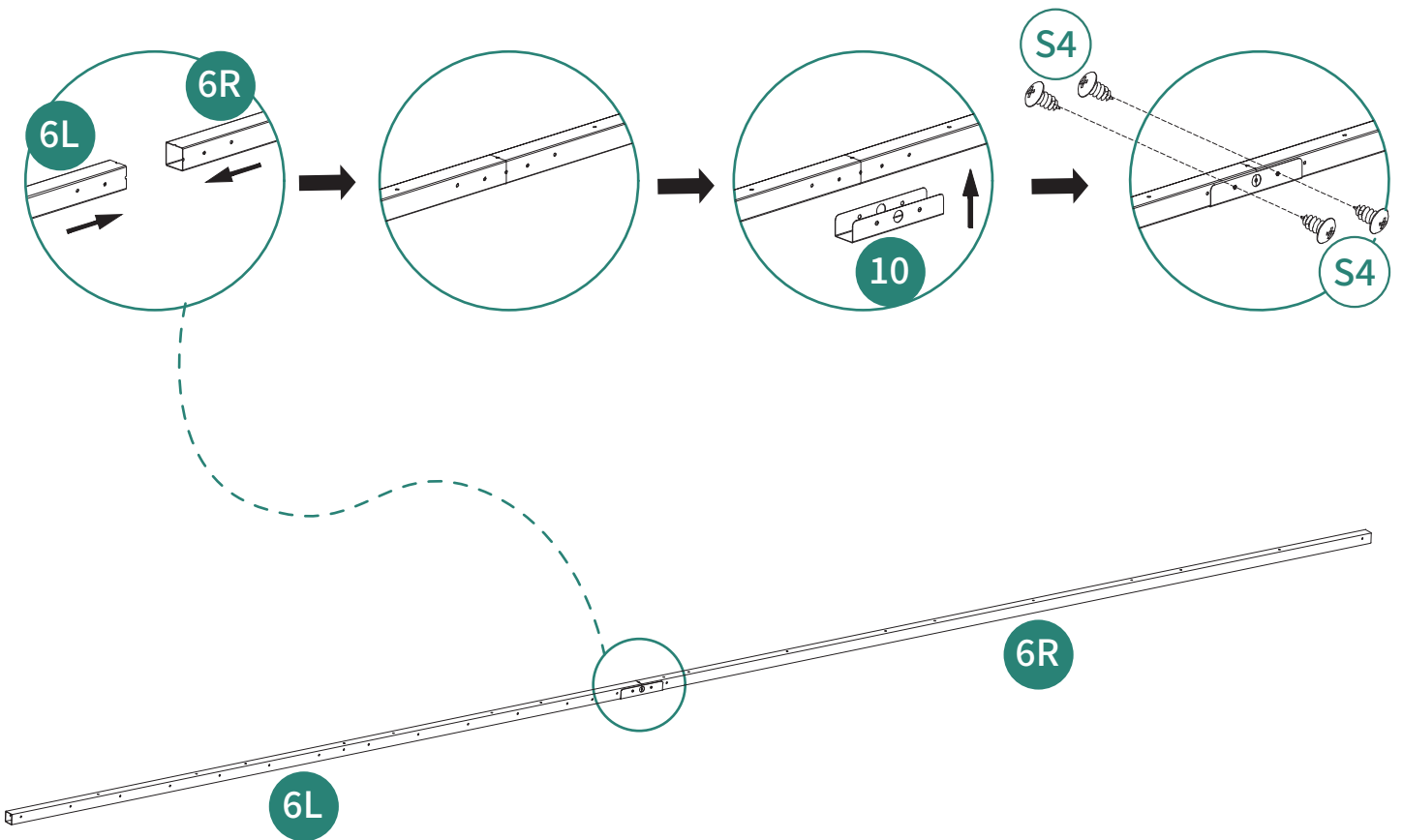

**7**  
**X2**

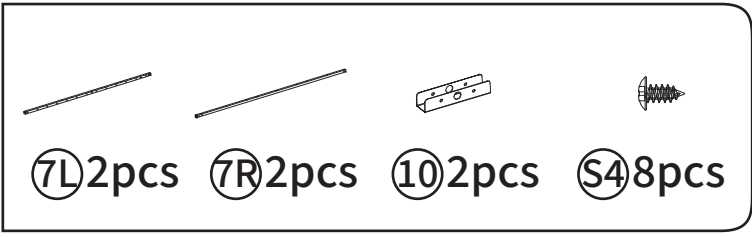

⑦L 2pcs   ⑦R 2pcs   ⑩ 2pcs   S4 8pcs

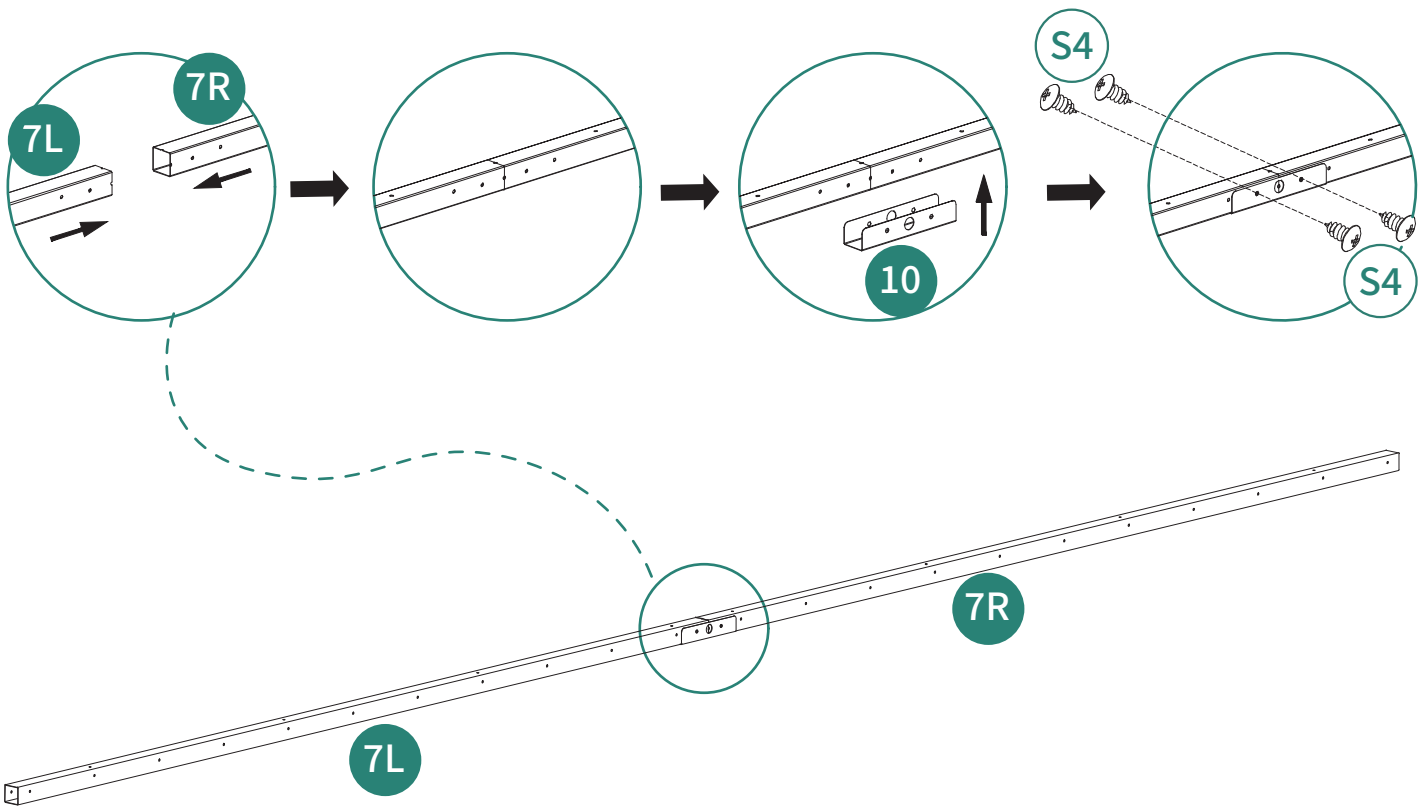

8

  
⑧L 1pc

  
⑧R 1pc

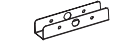
  
⑩ 1pc

  
S4 4pcs

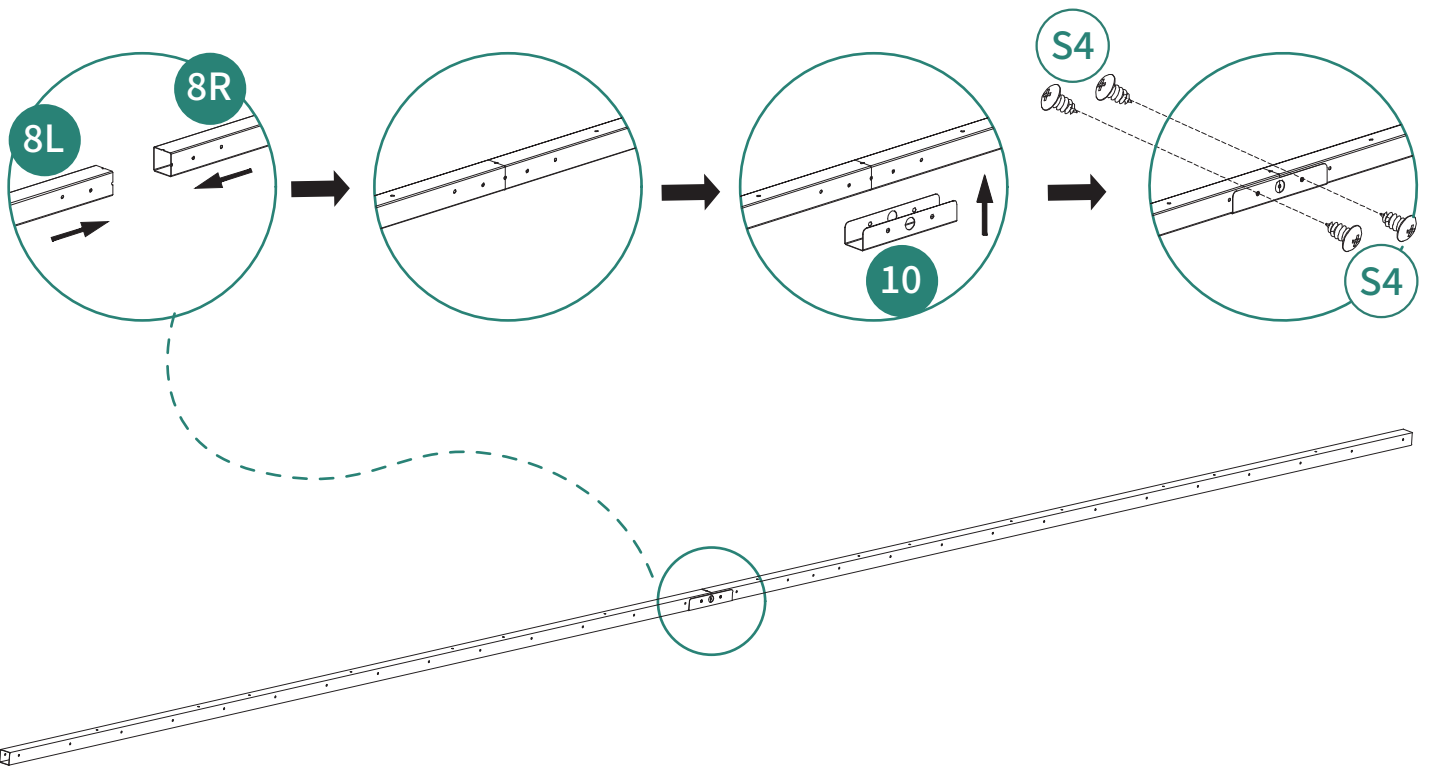

# 9



ⓕ 4pcs Ⓢ 48pcs

NOTES:

When assembling the beam:

1. Make sure parts (7L, 7R, 8L, 8R) have the sides with closely spaced holes facing outward, and the sides with widely spaced holes facing upward.
2. Ensure parts (6L, 6R) have the sides with rectangular latch lock slot facing downward. Part 6L should be on the left side and part 6R on the right.

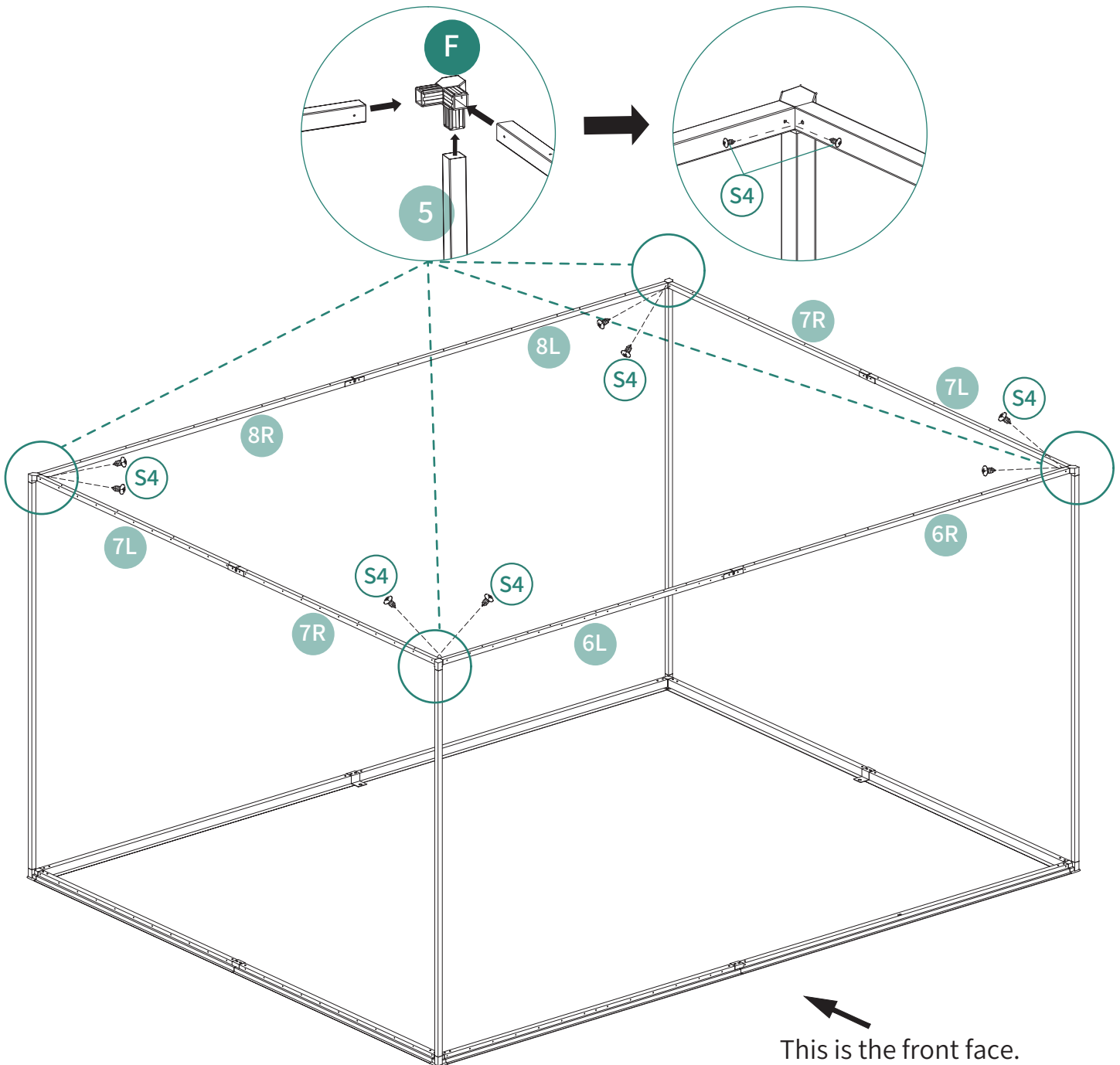

# 10



36 1pc

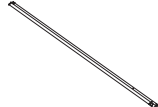

59 2pcs



S4 6pcs

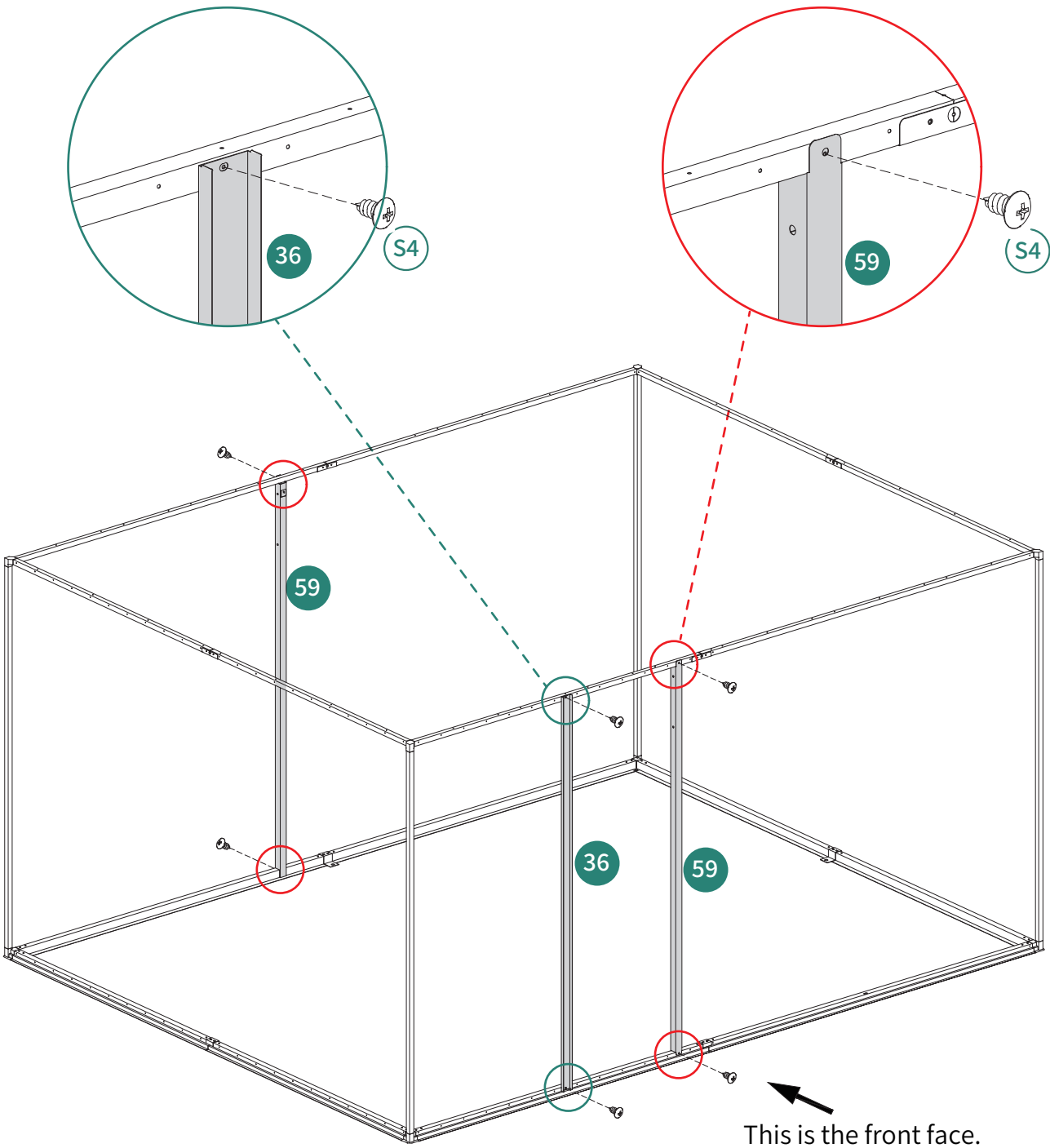

# 11

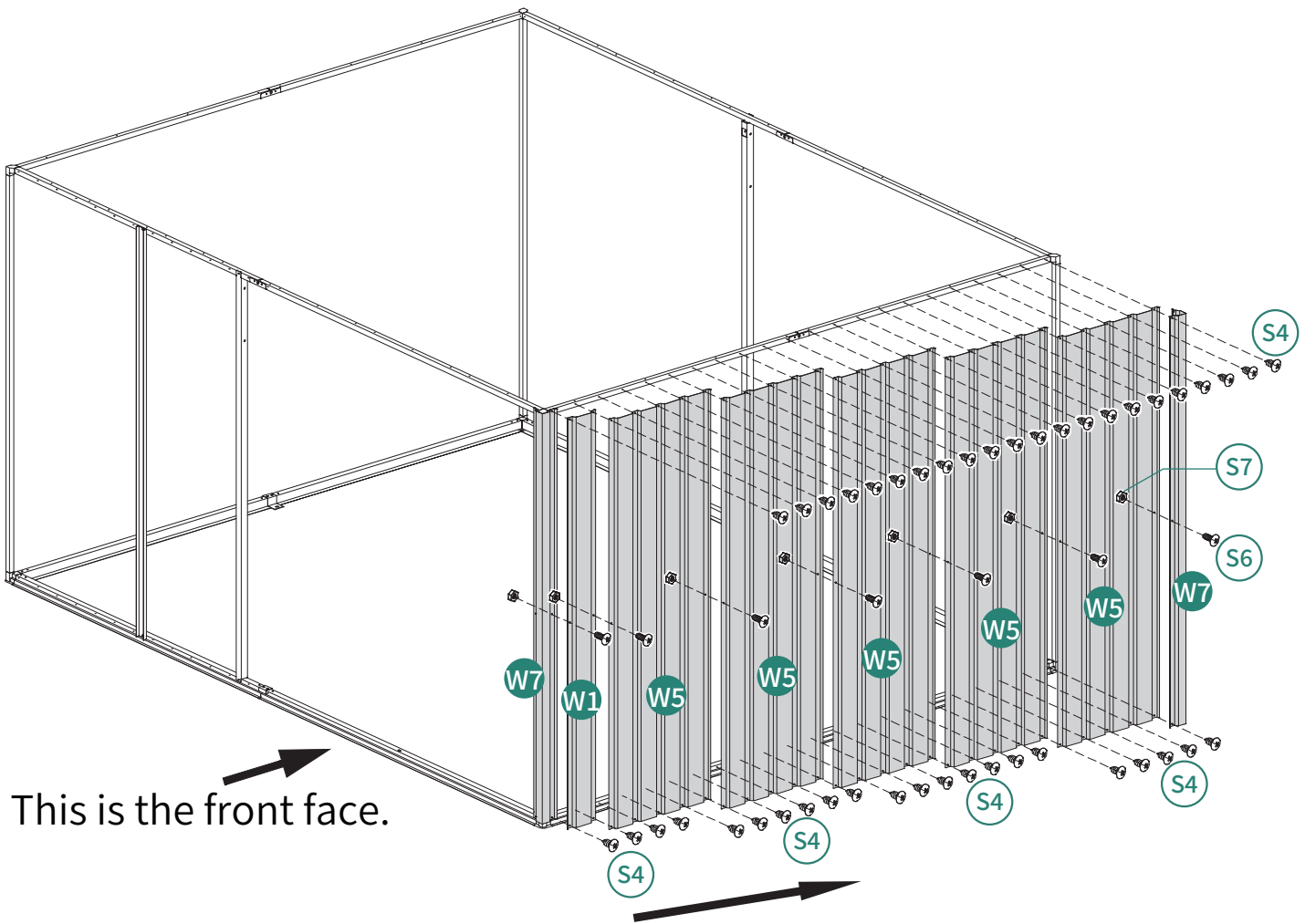

-  (W1) 1pc
-  (W5) 5pcs
-  (W7) 2pcs
-  (S4) 44pcs
-  (S6) 7pcs
-  (S7) 7pcs



This is the front face.

Secure the screws sequentially as indicated by the arrow.

# 12

-  W3 1pc
-  W5 6pcs
-  W7 1pc
-  S4 56pcs
-  S6 8pcs
-  S7 8pcs

This is the front face.

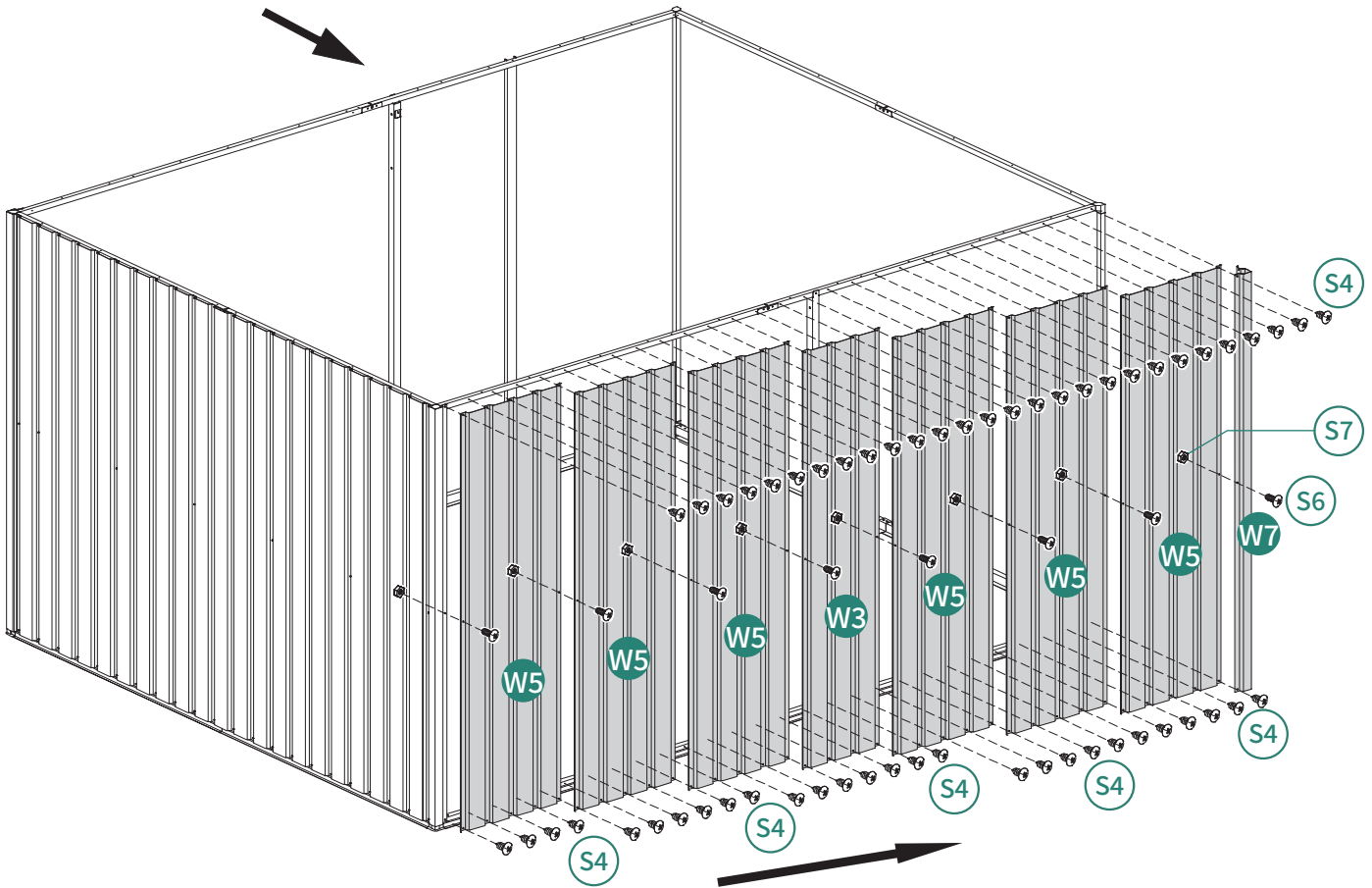

Secure the screws sequentially as indicated by the arrow.

# 13

-  W1 1pc
-  W5 5pcs
-  W7 1pc
-  S4 44pcs
-  S6 7pcs
-  S7 7pcs

This is the front face.

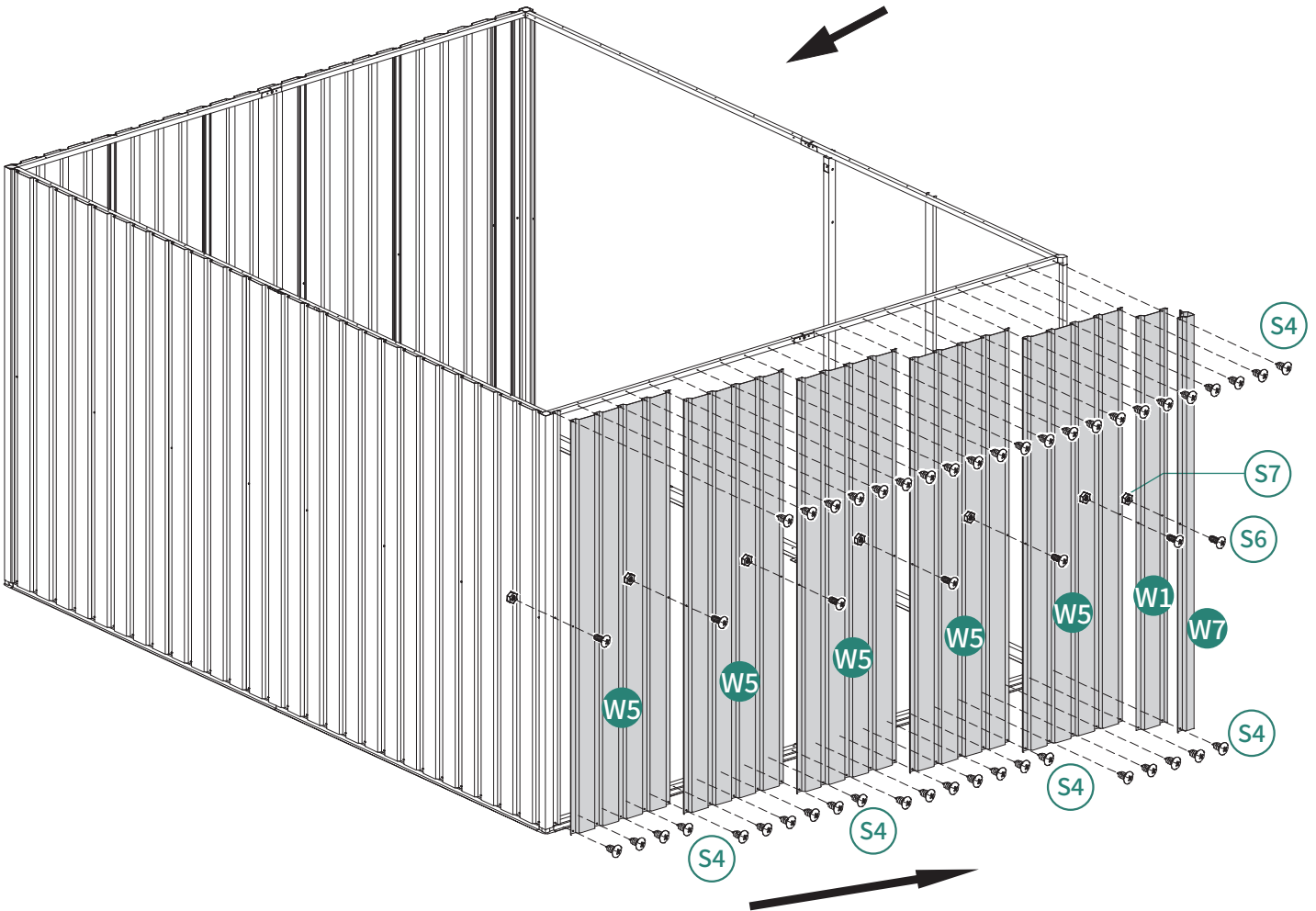

Secure the screws sequentially as indicated by the arrow.

# 14

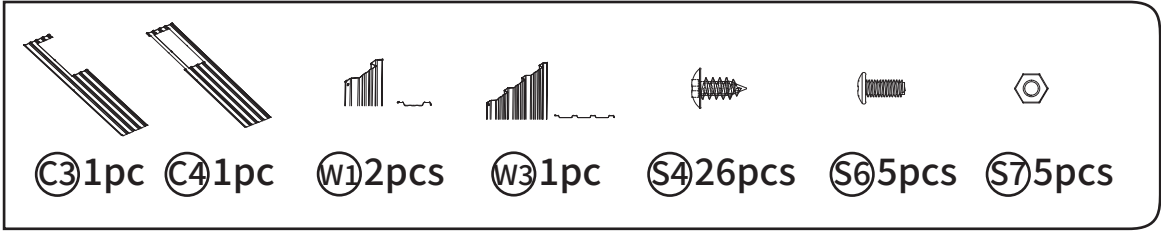

Parts list for step 14:

- C3 1pc
- C4 1pc
- W1 2pcs
- W3 1pc
- S4 26pcs
- S6 5pcs
- S7 5pcs

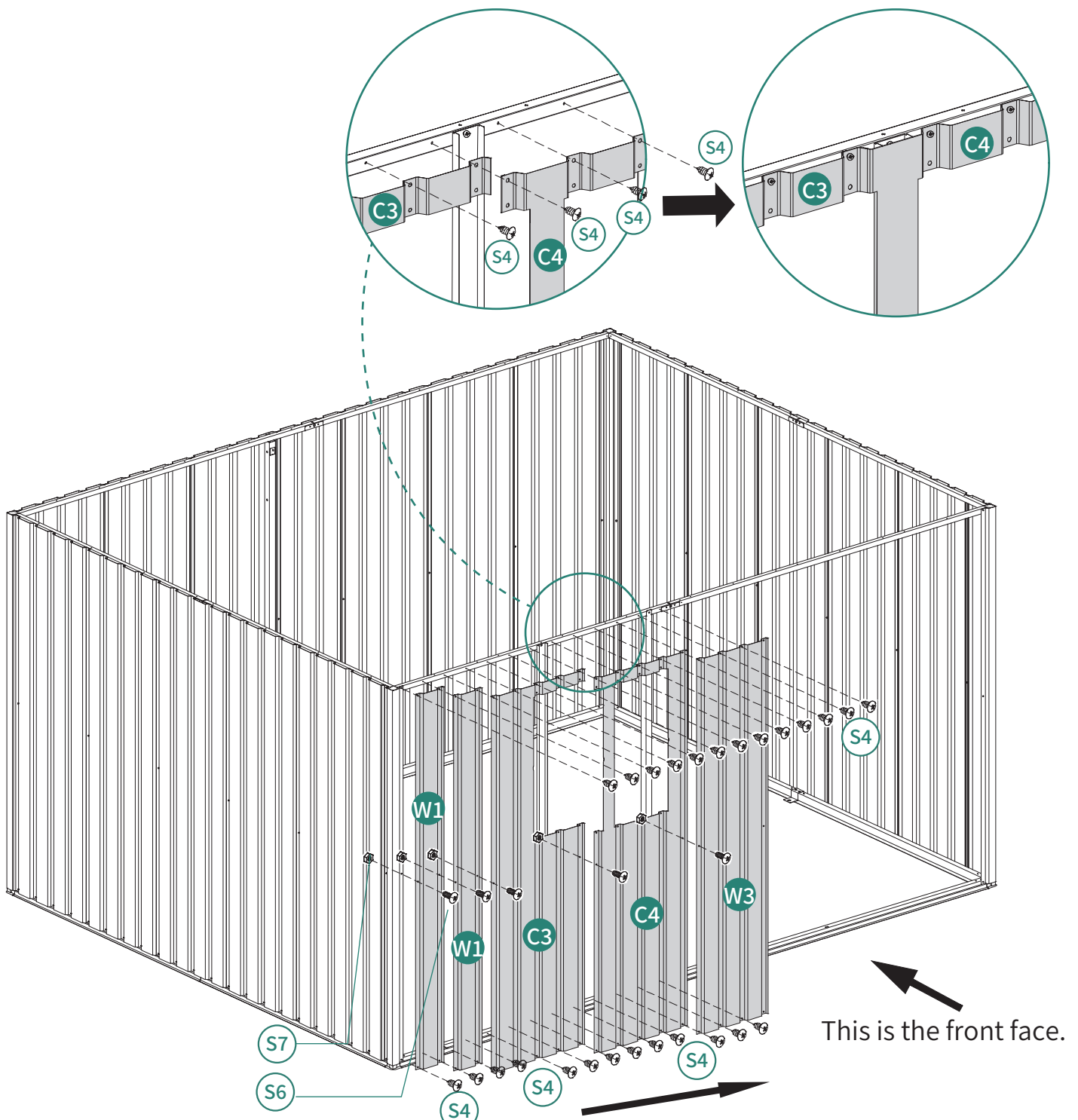

This is the front face.

Secure the screws sequentially as indicated by the arrow.

# 15

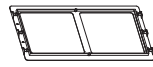

F12 2pcs

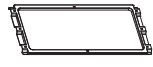

F13 2pcs

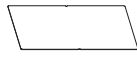

F14 2pcs



S4 16pcs

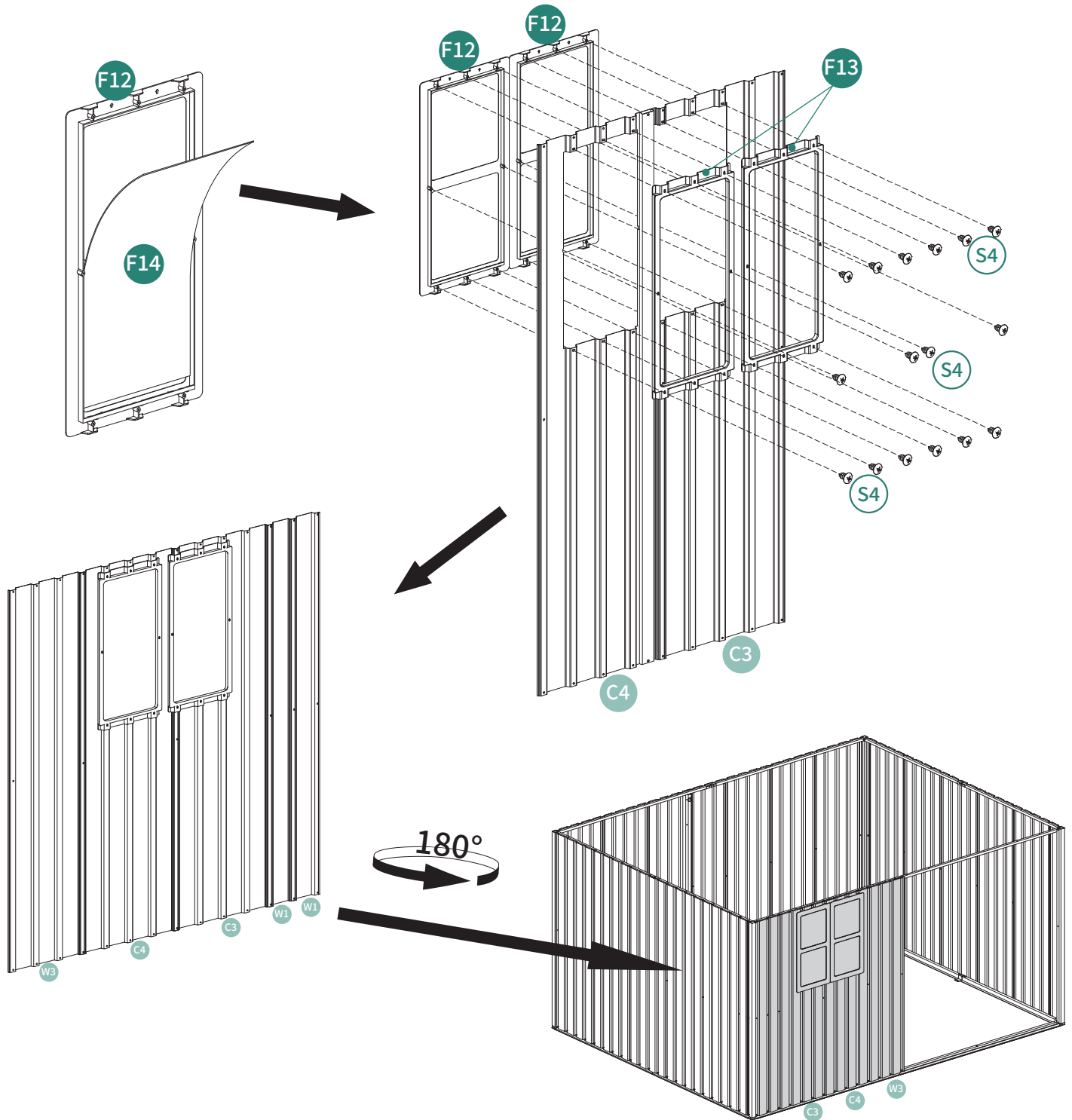

# 16



17L 1pc



17R 1pc



S4 8pcs



S6 2pcs



S7 2pcs

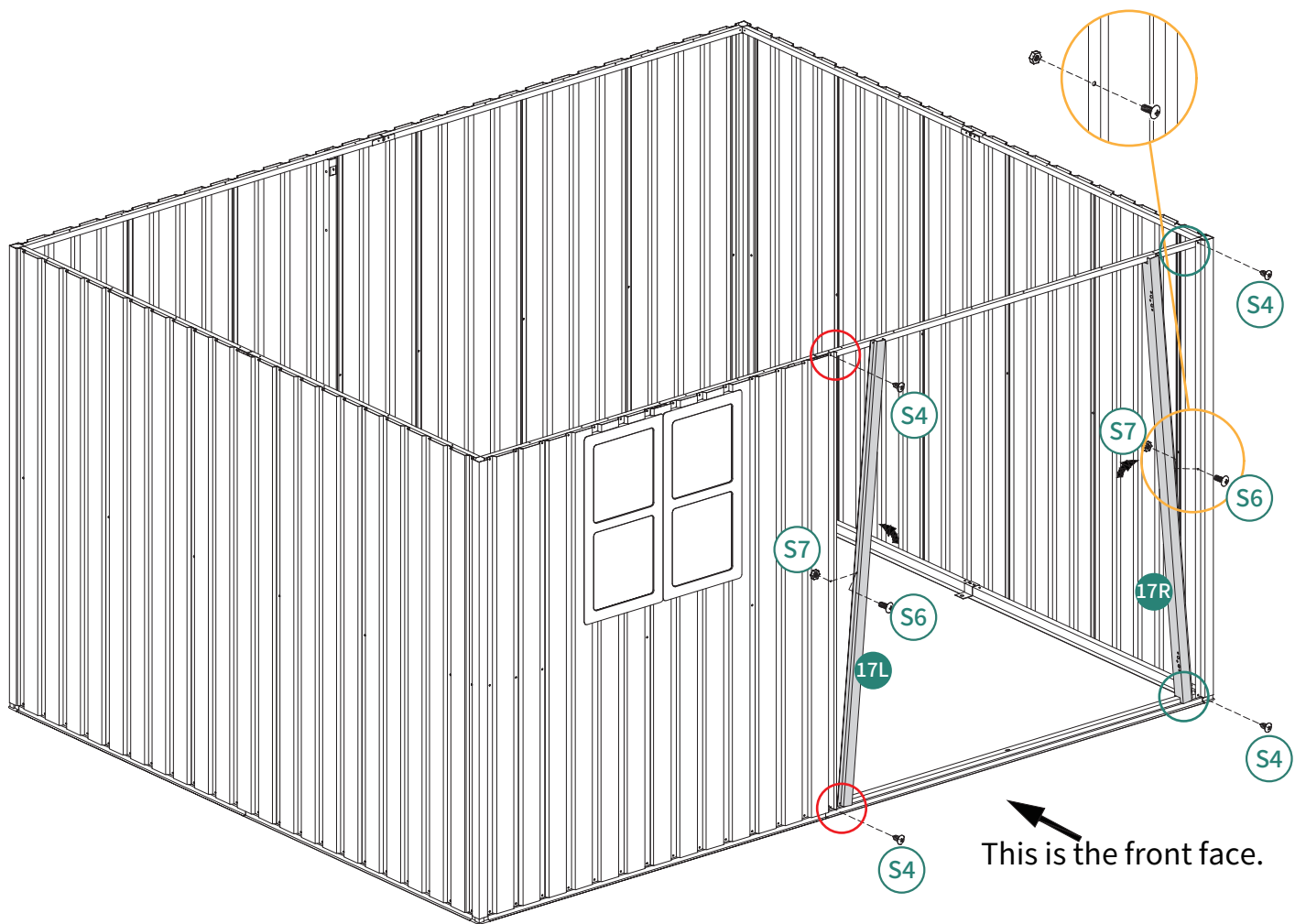

Inside:

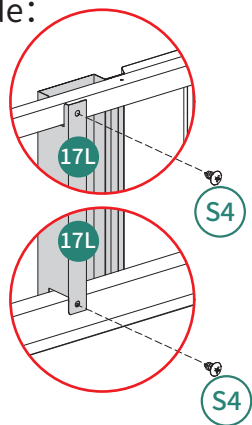

Outside:

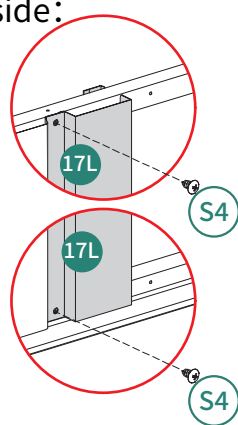

Inside:

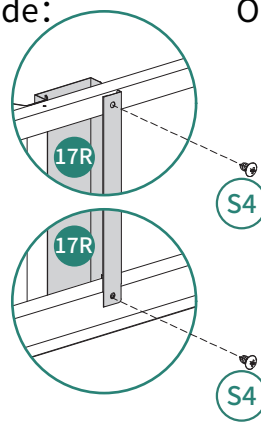

Outside:

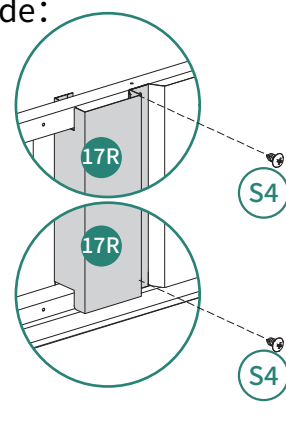

**17**  
**X2**

- 
- ⑩F 2pcs
  - ⑪B 2pcs
  - ⑪F 2pcs
  - ⑳L 2pcs
  - ㉑R 2pcs
  - Ⓢ6 4pcs
  - Ⓢ7 4pcs

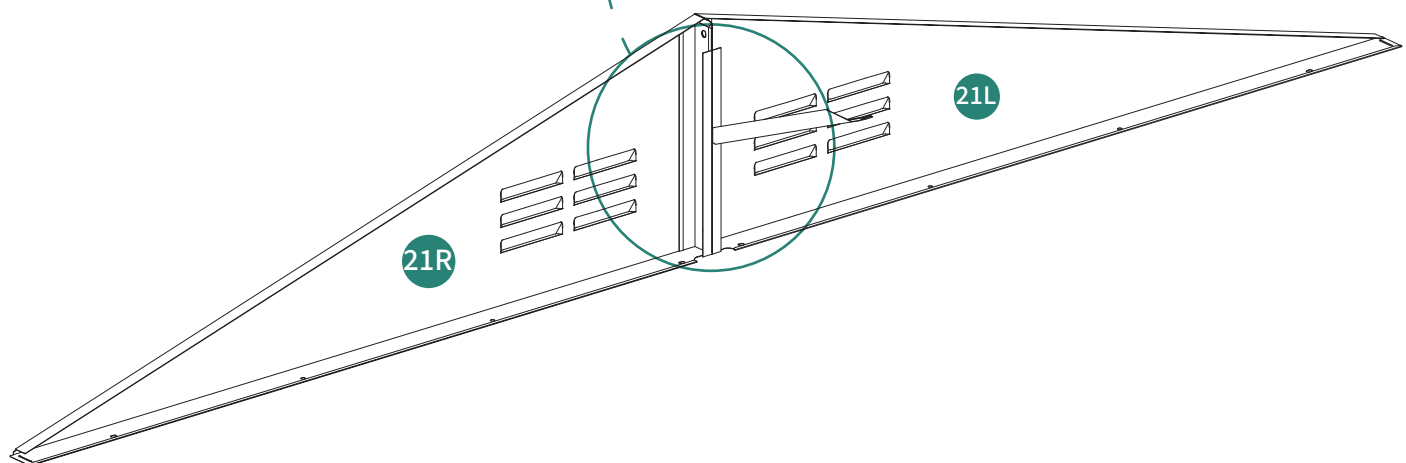
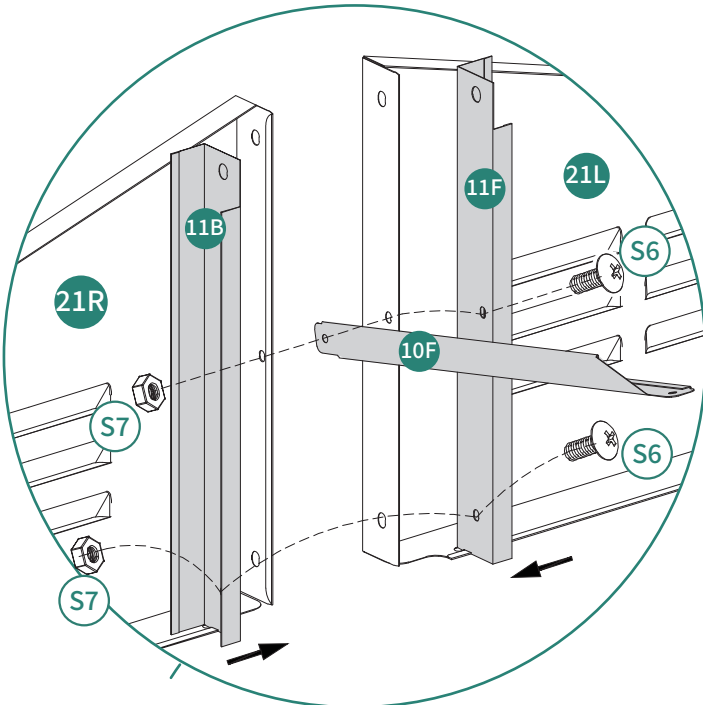

# 18



S4 16pcs

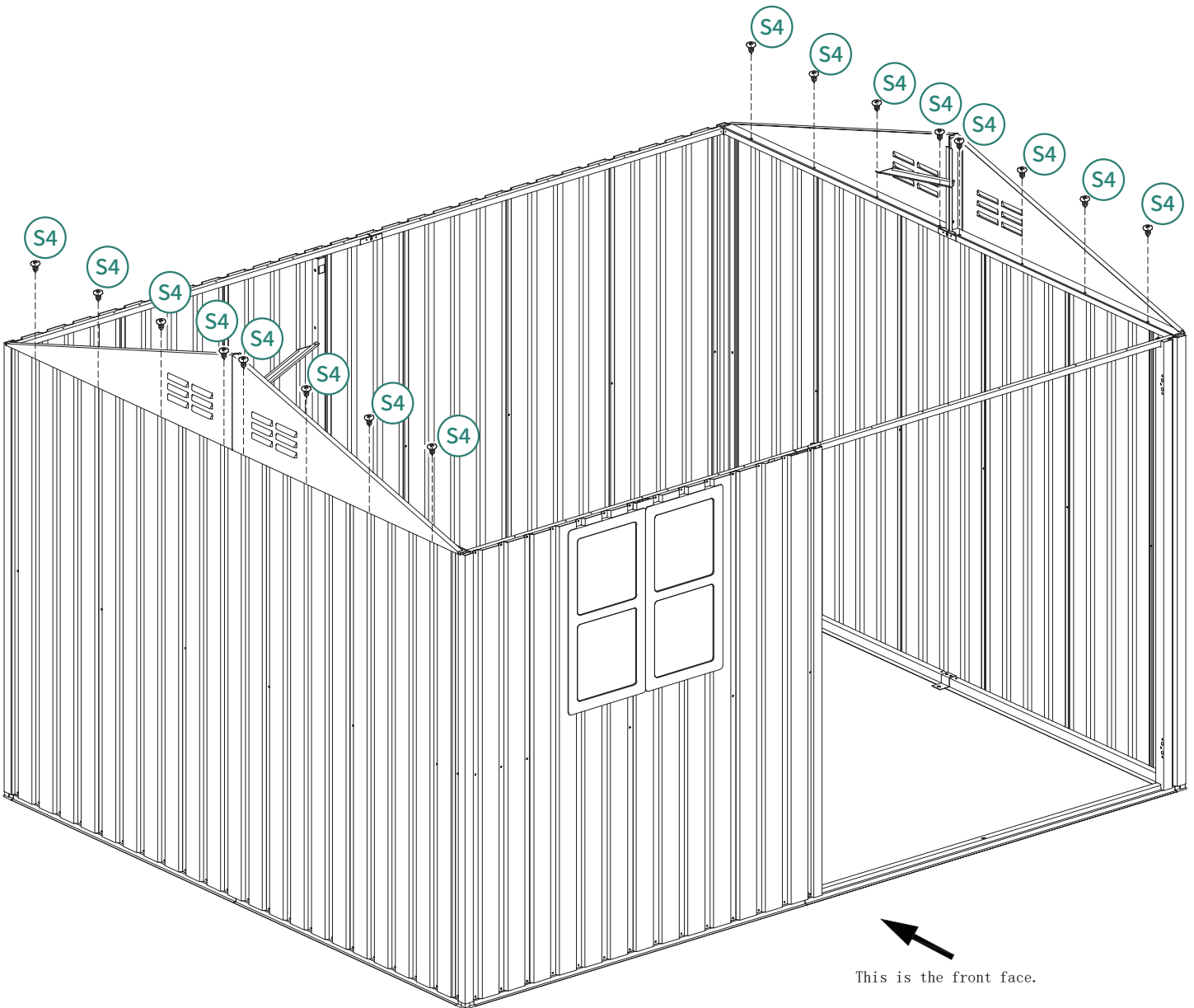





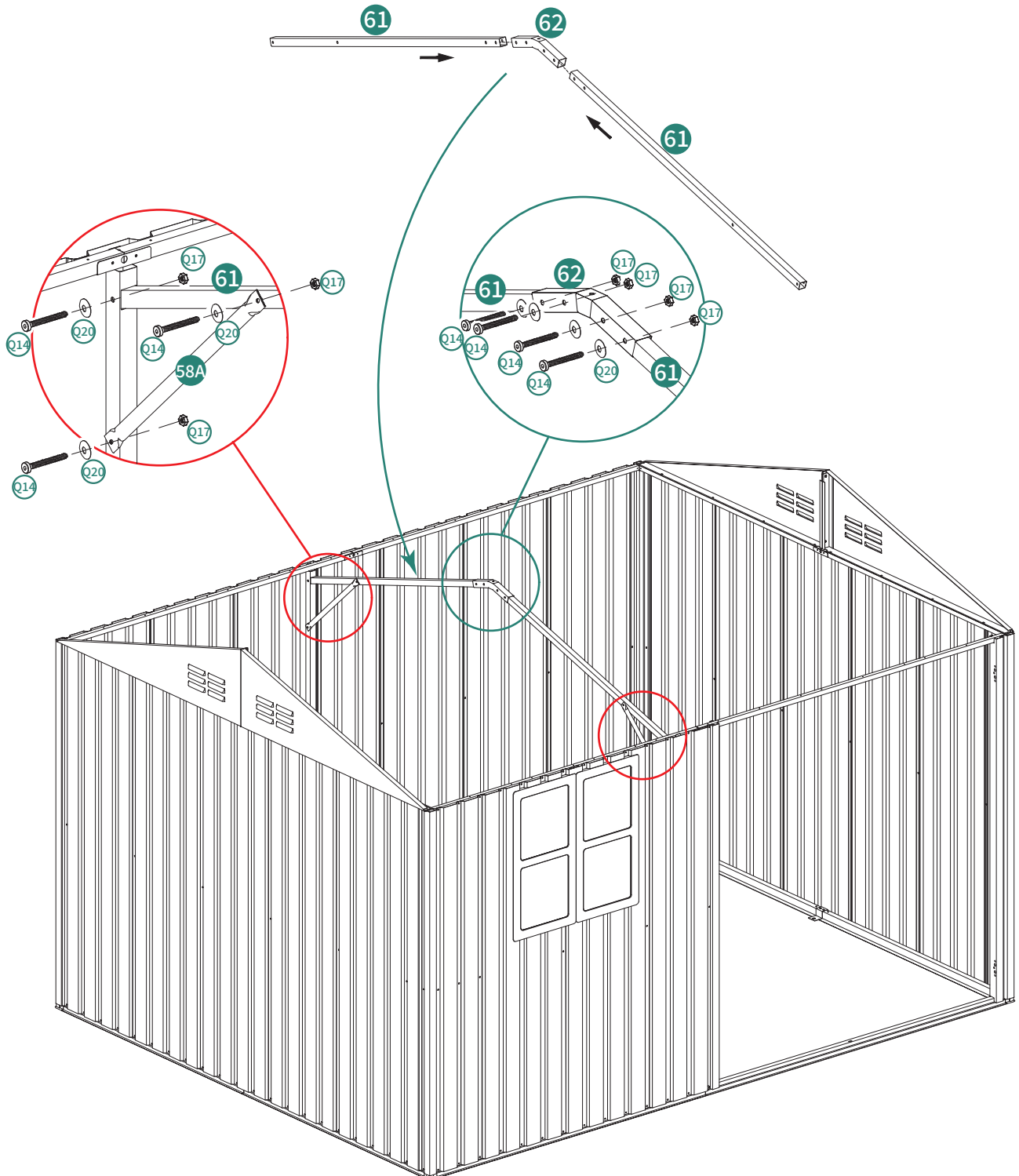

# 19



58A 2pcs 61 2pcs 62 1pc Q14 10pcs Q17 10pcs Q20 10pcs



# 20

-  (9Y) 2pcs
-  (11A) 1pc
-  (11C) 1pc
-  (Q36) 4pcs
-  (Q17) 4pcs
-  (Q20) 4pcs

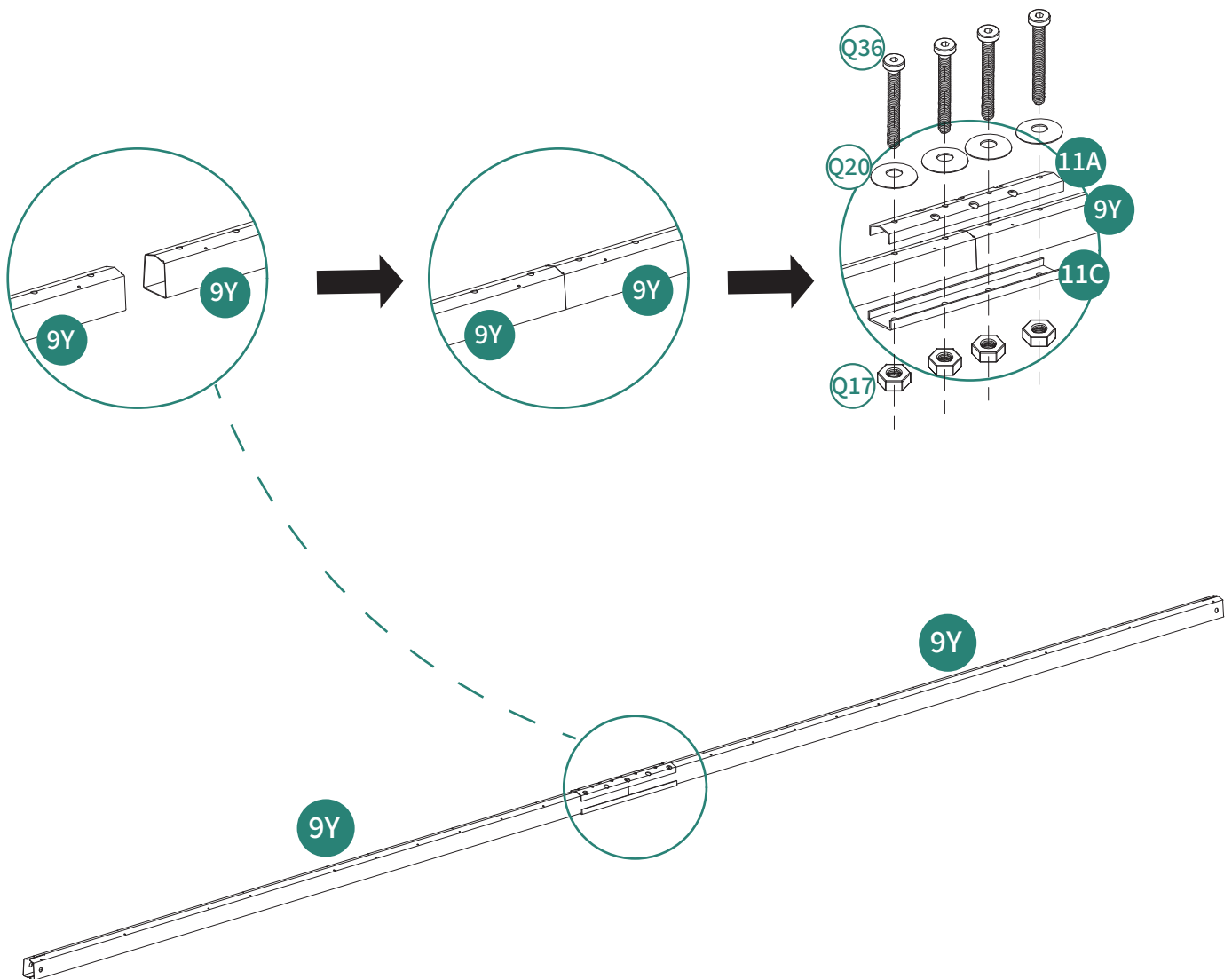

# 21



Q36 3pcs



Q17 2pcs



Q20 2pcs



S4 2pcs

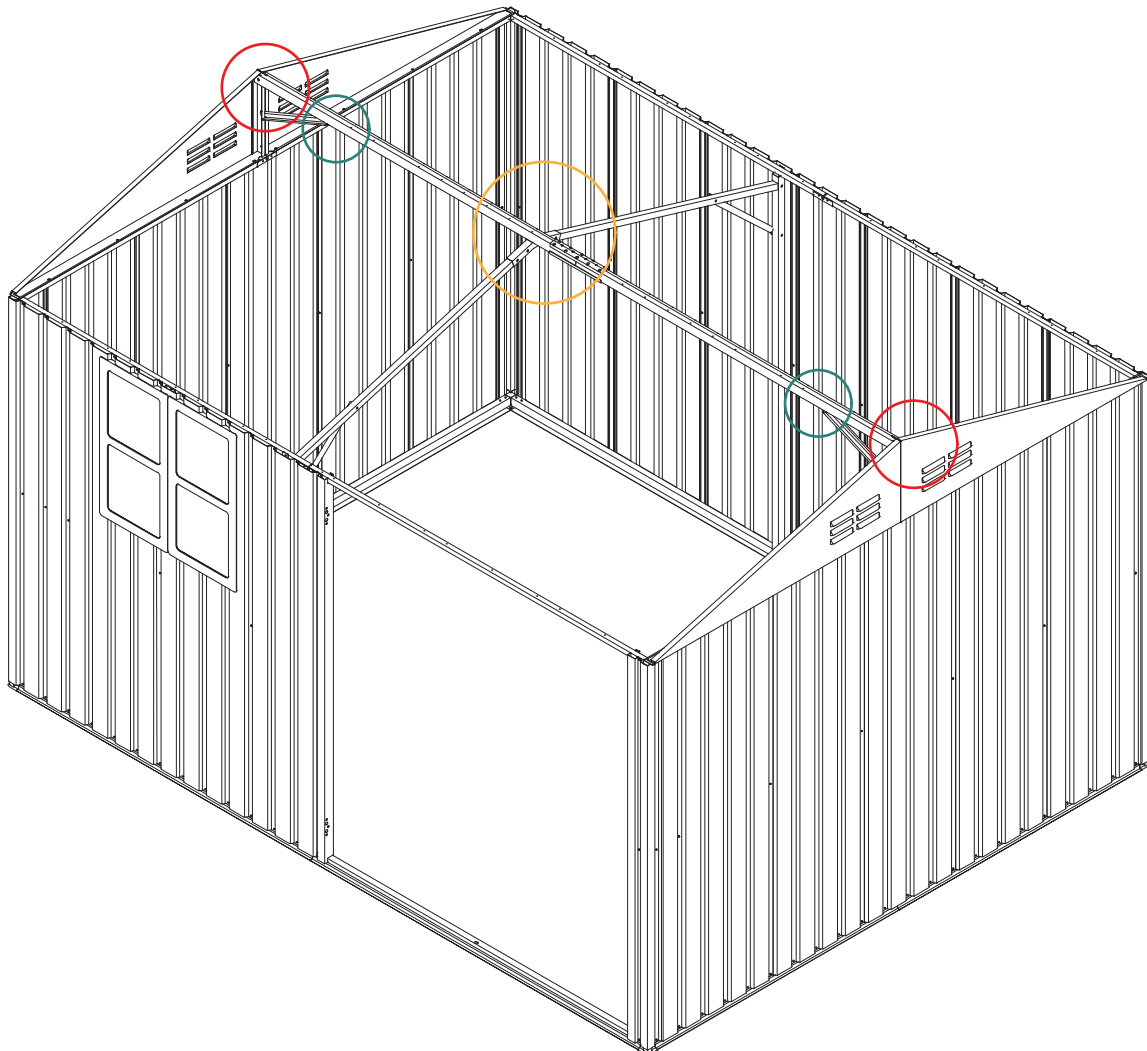
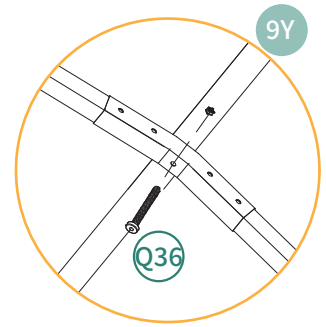
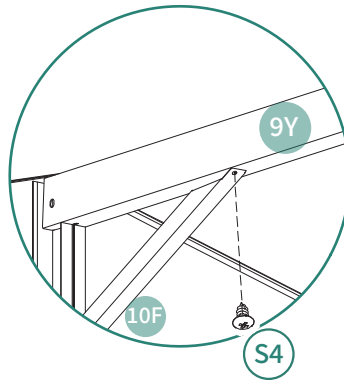
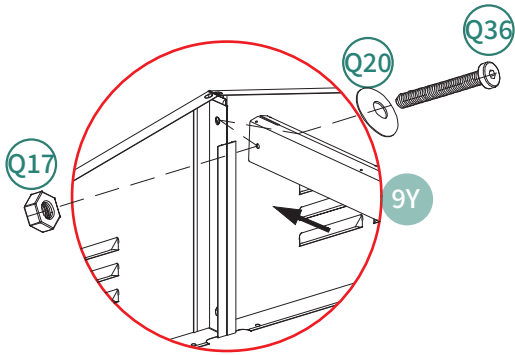

# 22

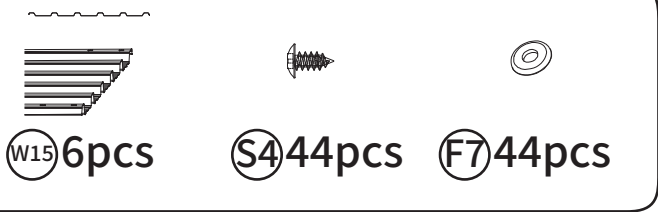

W15 6pcs      S4 44pcs      F7 44pcs

Place the side with small distance between holes and edges on the top

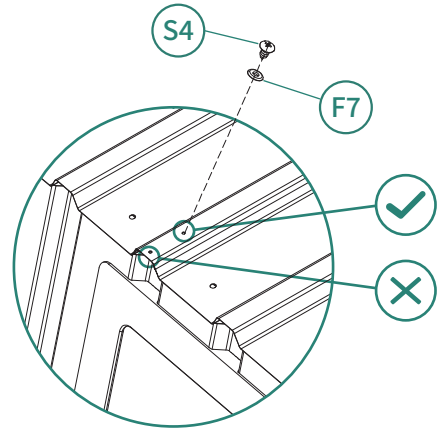
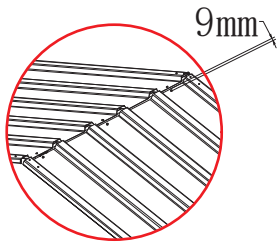

Pay attention to the placement of the fastening screws at the overlap joints when installing corrugated roofing.

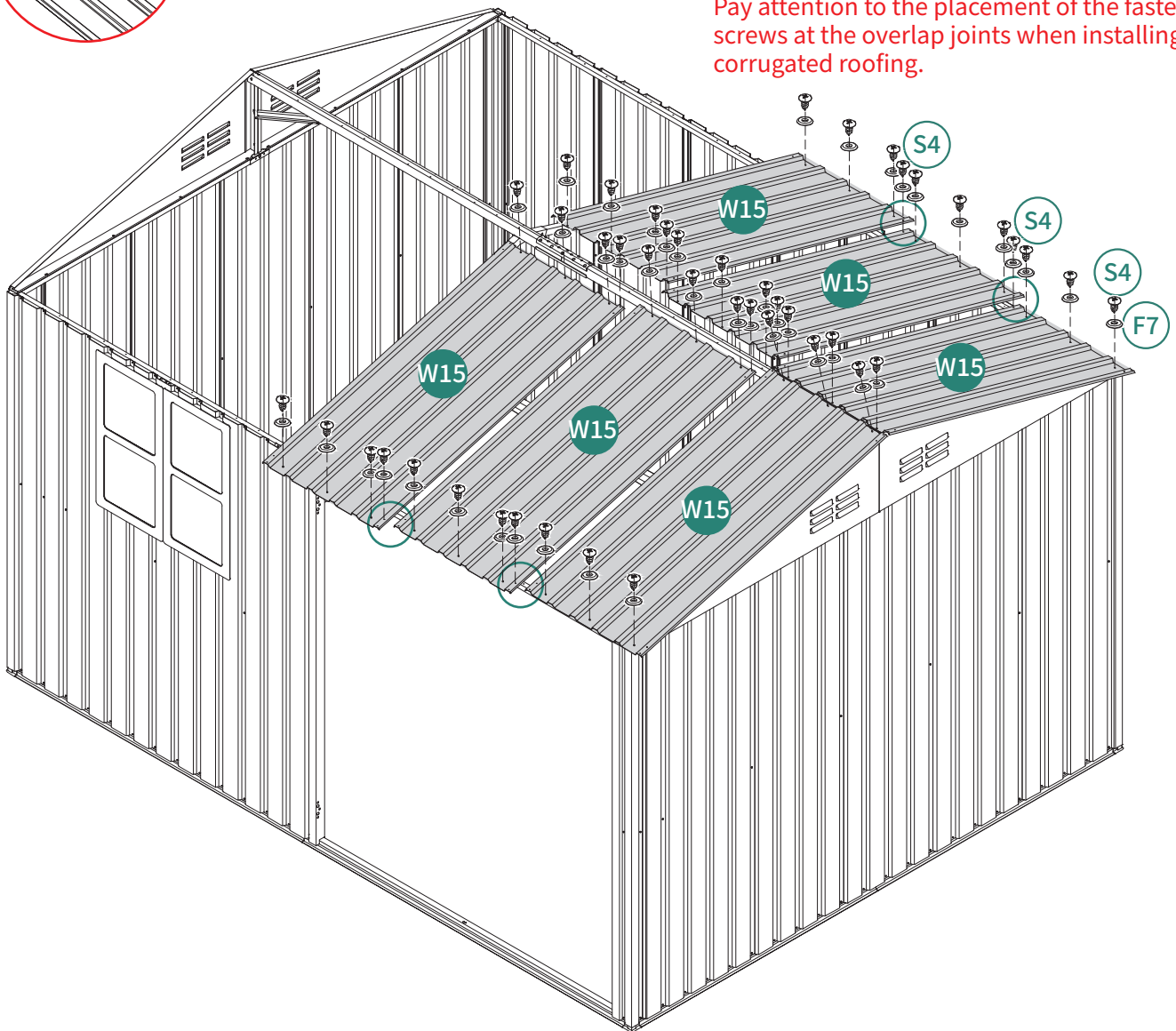

# 23

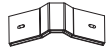

F18 1pc



S8 2pcs



F7 2pcs

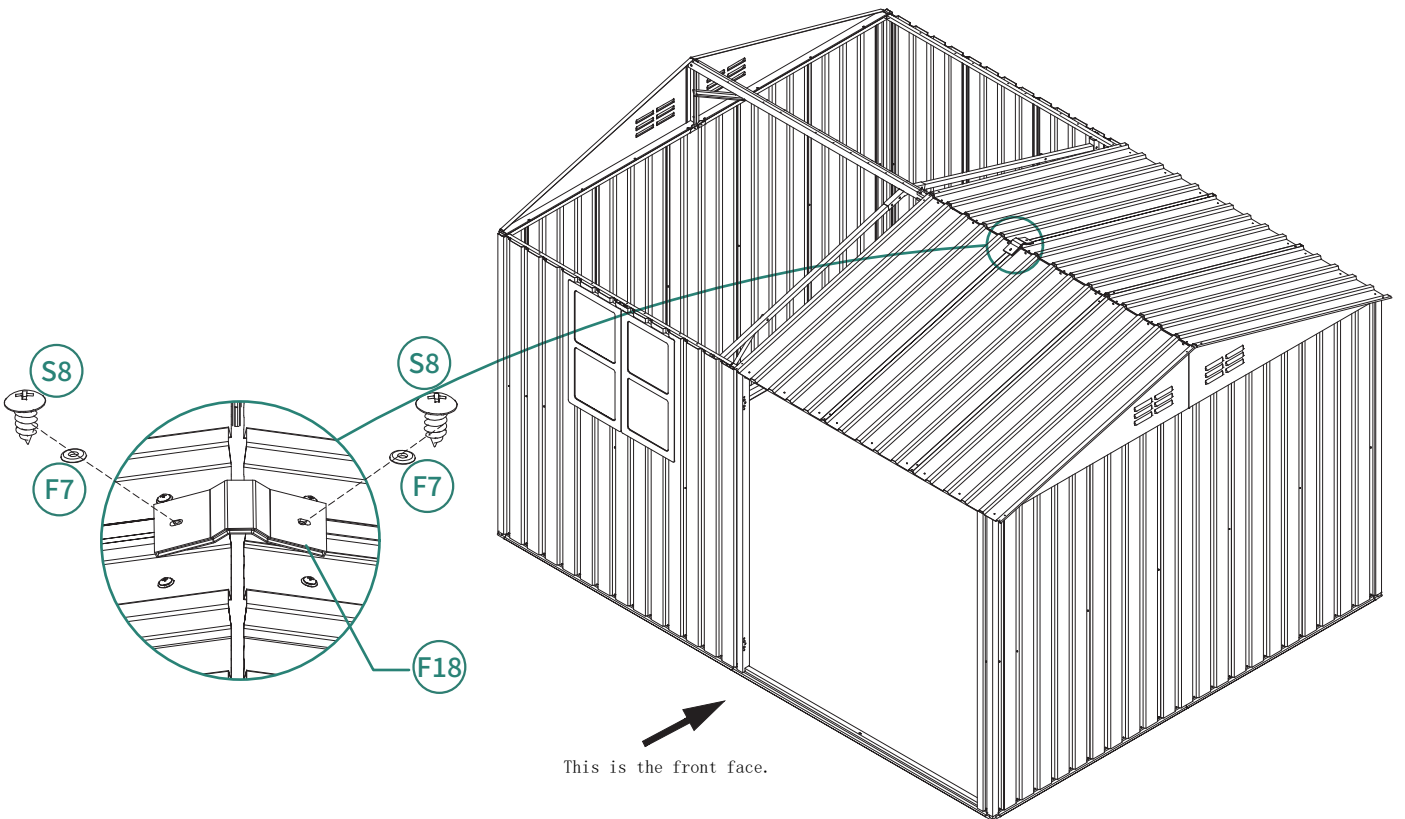

# 24

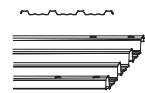

W12 4pcs



S4 24pcs



F7 24pcs

Place the side with small distance between holes and edges on the top

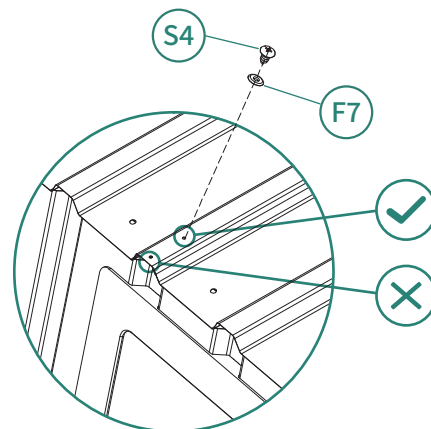
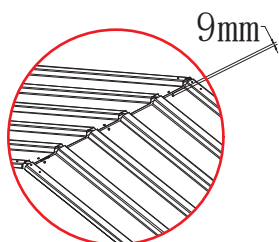

Pay attention to the placement of the fastening screws at the overlap joints when installing corrugated roofing.

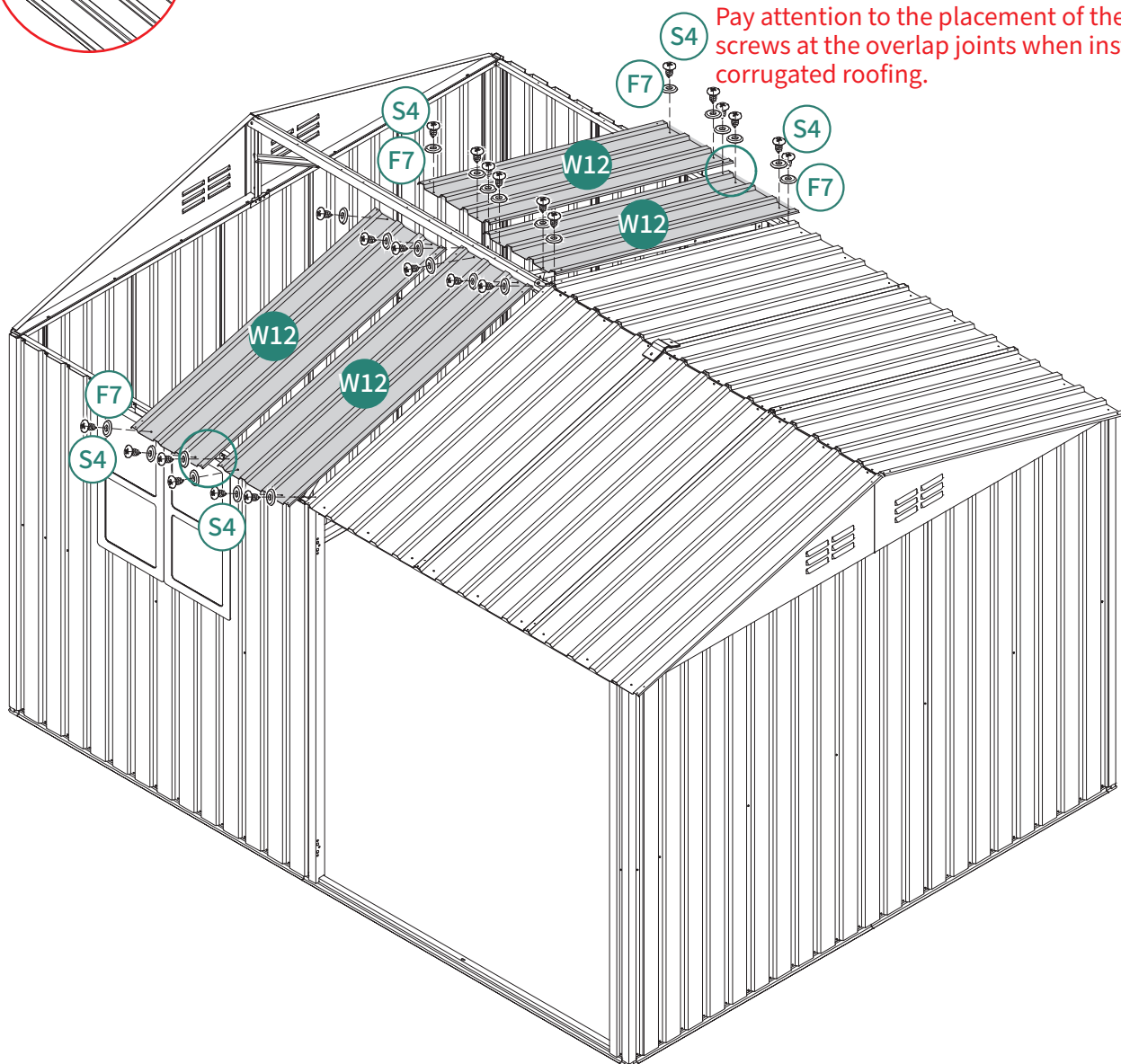

# 25



⑱ 1pc



⑴⑱ 1pc



⑴⑳ 2pcs



⑴㉑ 2pcs



⑴㉒ 4pcs

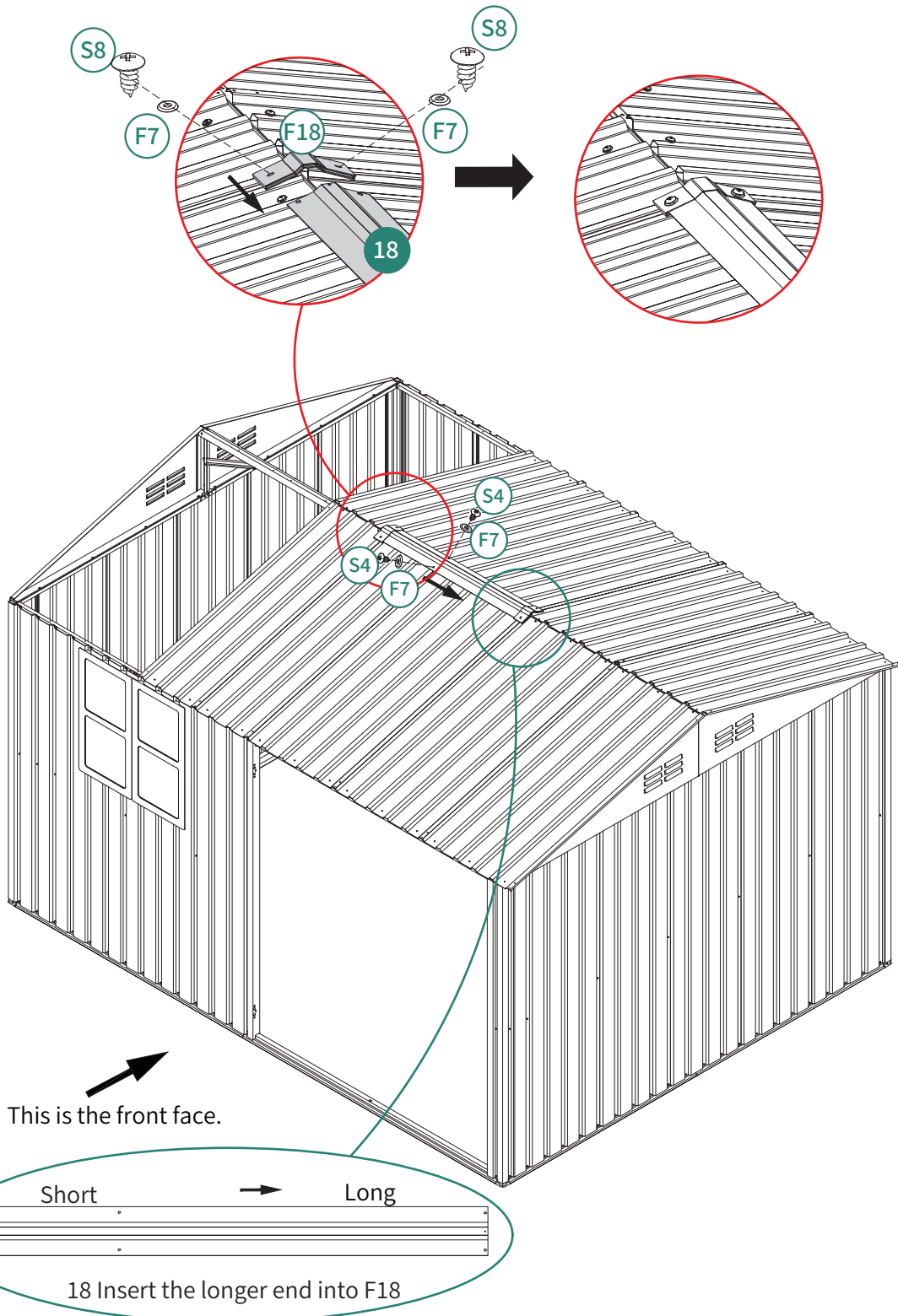

# 26

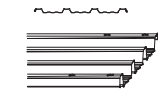

W12 2pcs

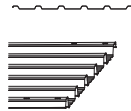

W15 2pcs



S4 28pcs



F7 28pcs

Place the side with small distance between holes and edges on the top

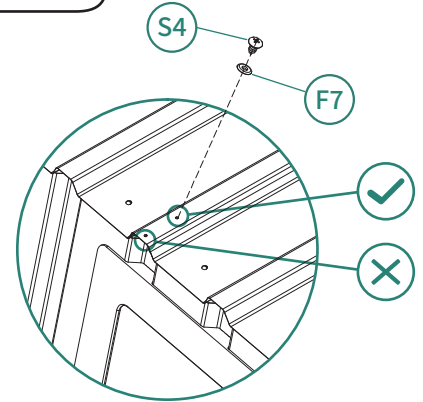
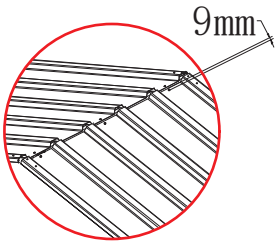

Pay attention to the placement of the fastening screws at the overlap joints when installing corrugated roofing.

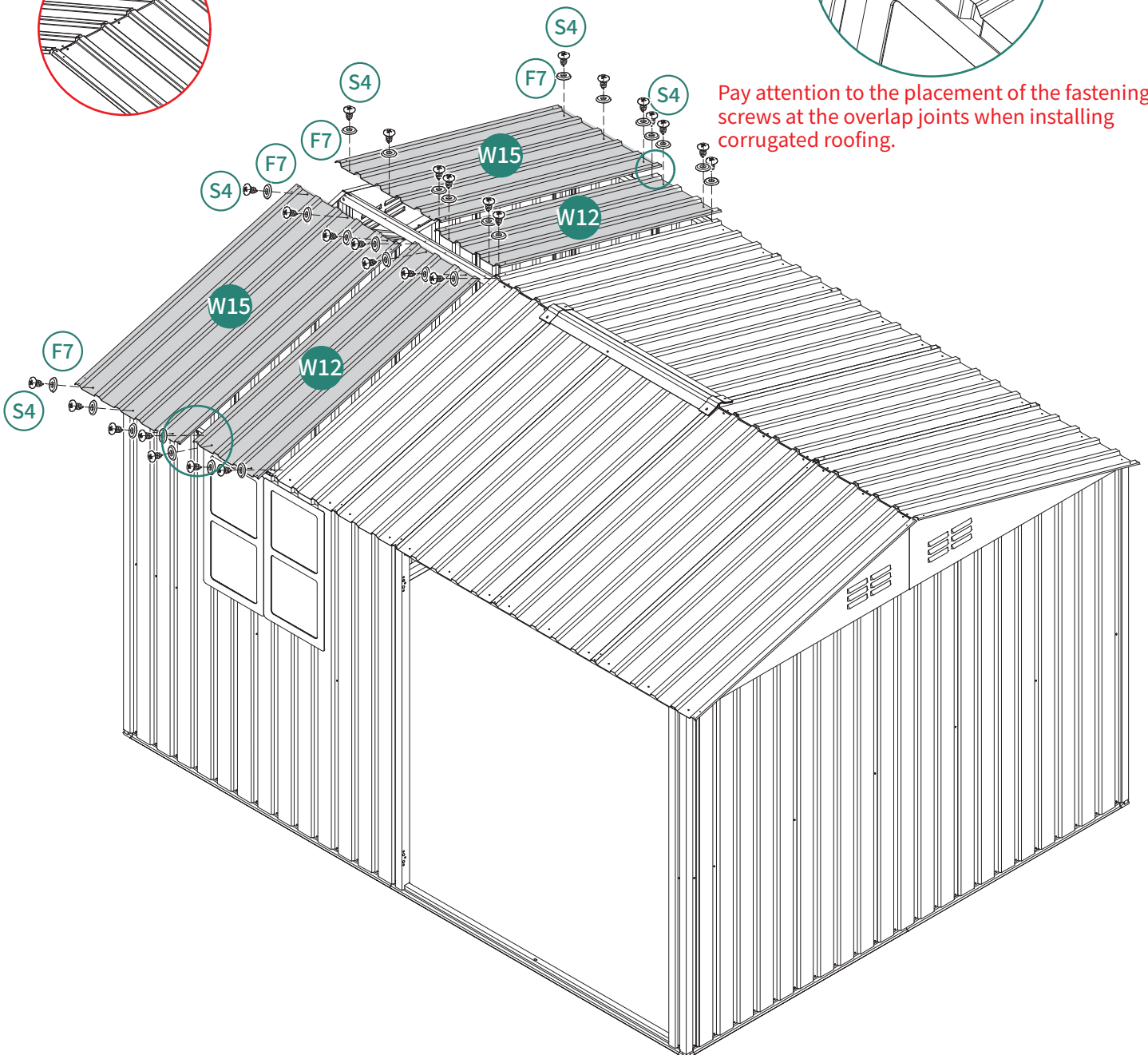

# 27



(20) 4pcs



(S4) 8pcs



(F7) 8pcs

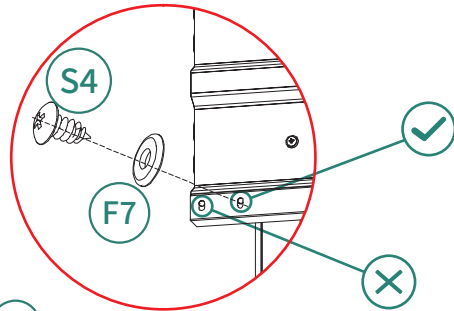
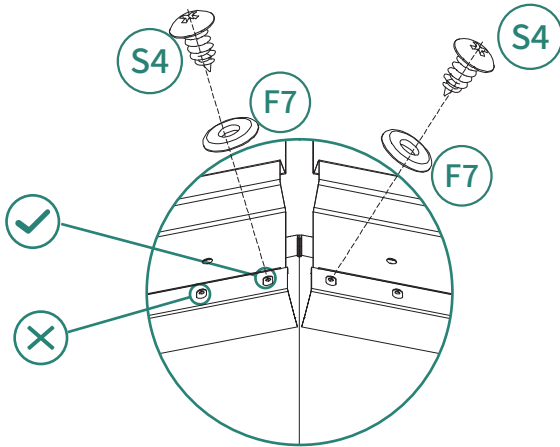

Pay close attention to the positioning of the fixing screws at the joint connections.

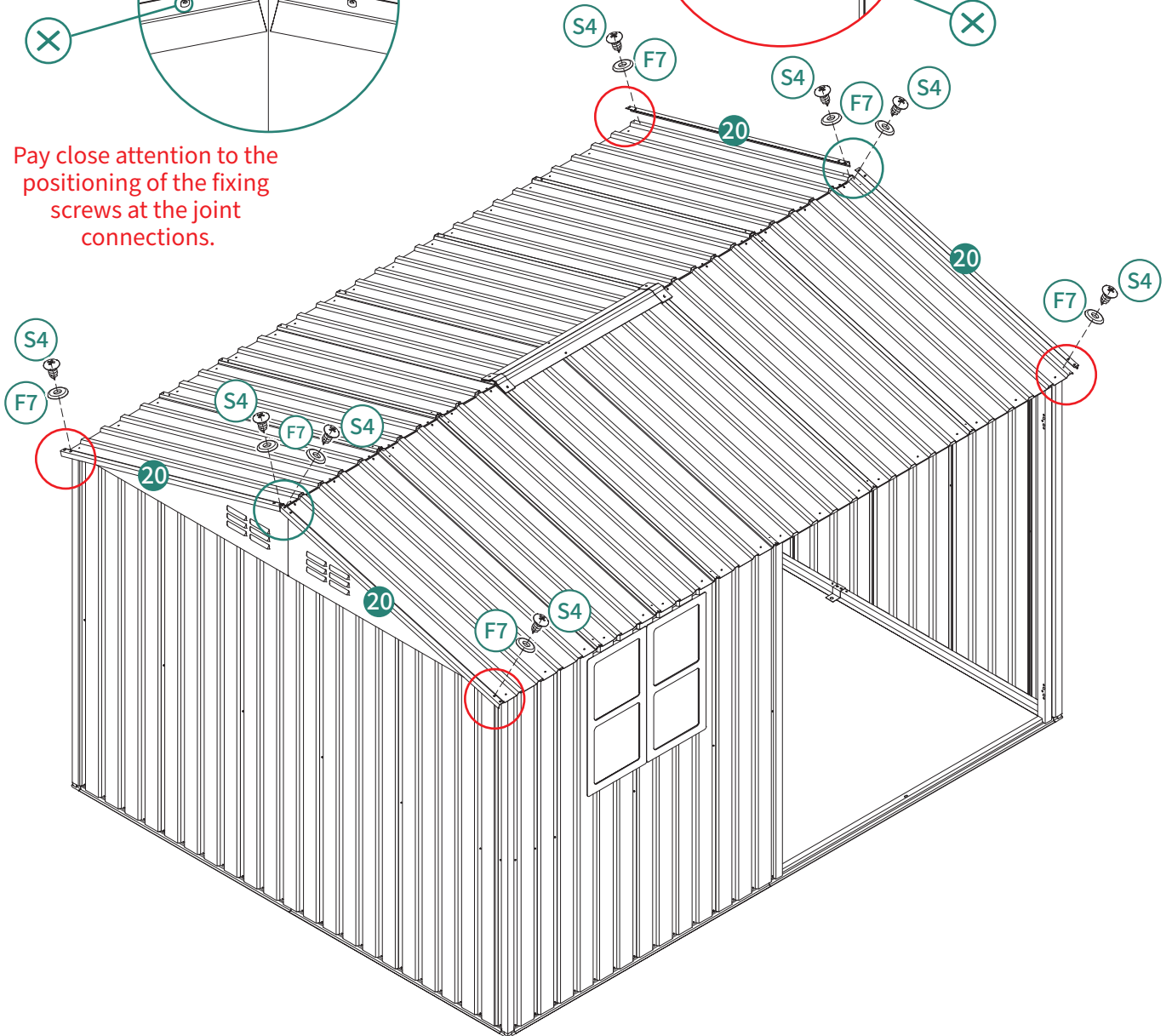

# 28

— — — — —       
①9L 1pc ①9R 1pc ①9B 1pc ①9F 1pc ④S4 10pcs ④S8 6pcs ④F4 4pcs ④F7 16pcs ④F10 2pcs

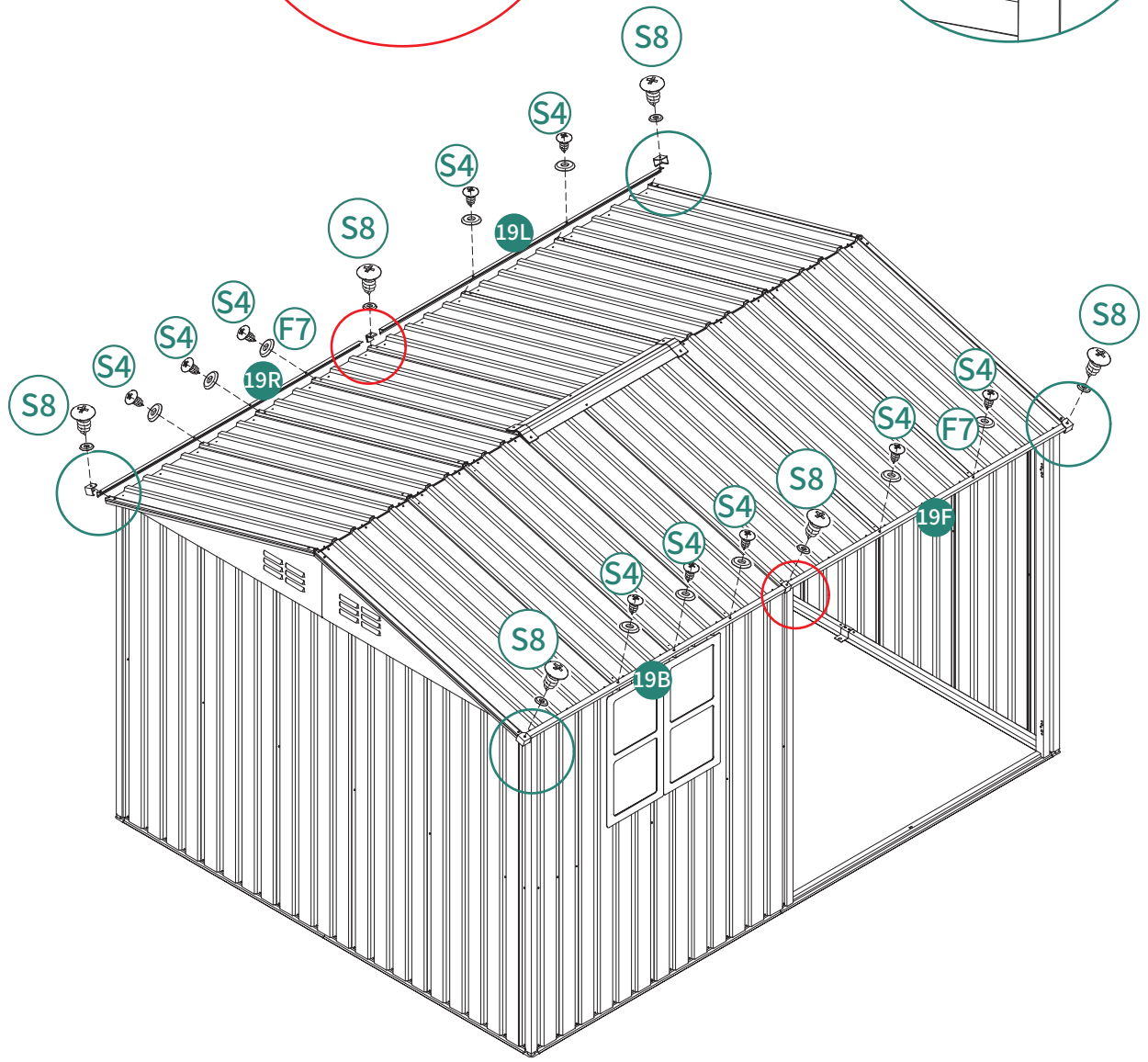
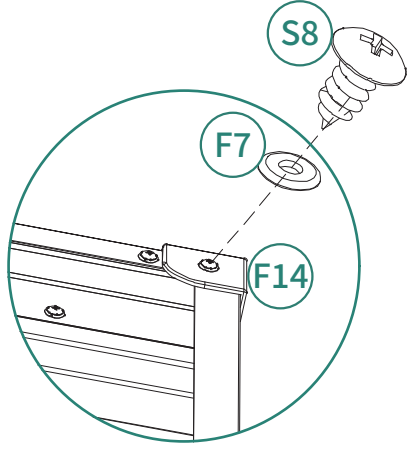
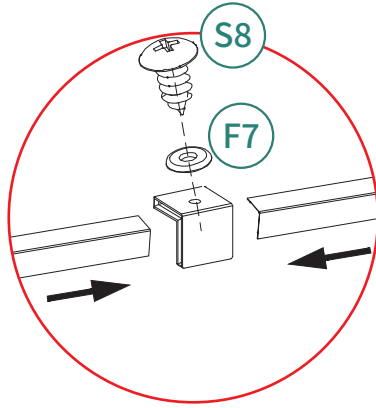





**29**

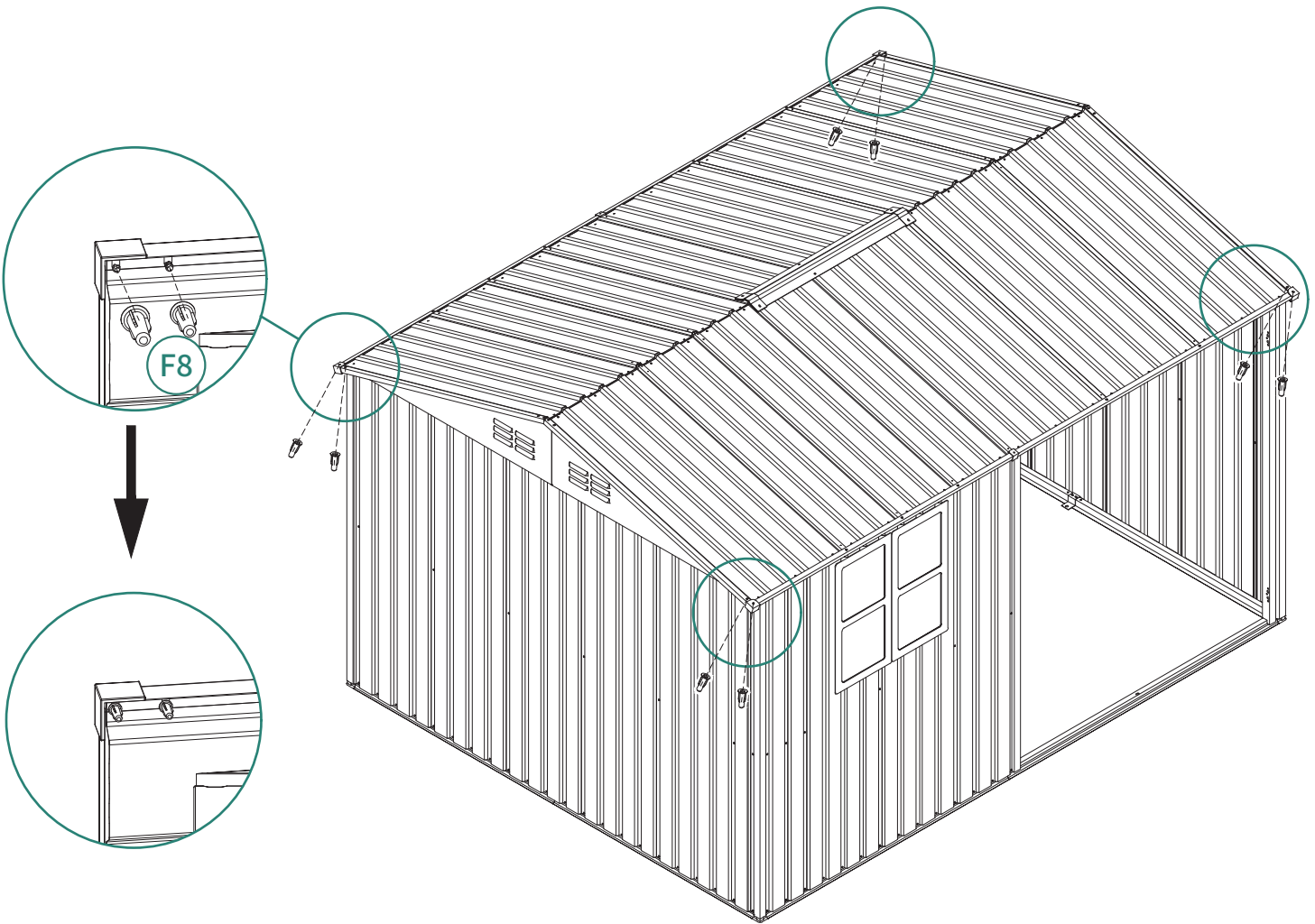

F8 8pcs



# 30

-  18F 1pc
-  18B 1pc
-  F5 1pc
-  S4 10pcs
-  F7 10pcs

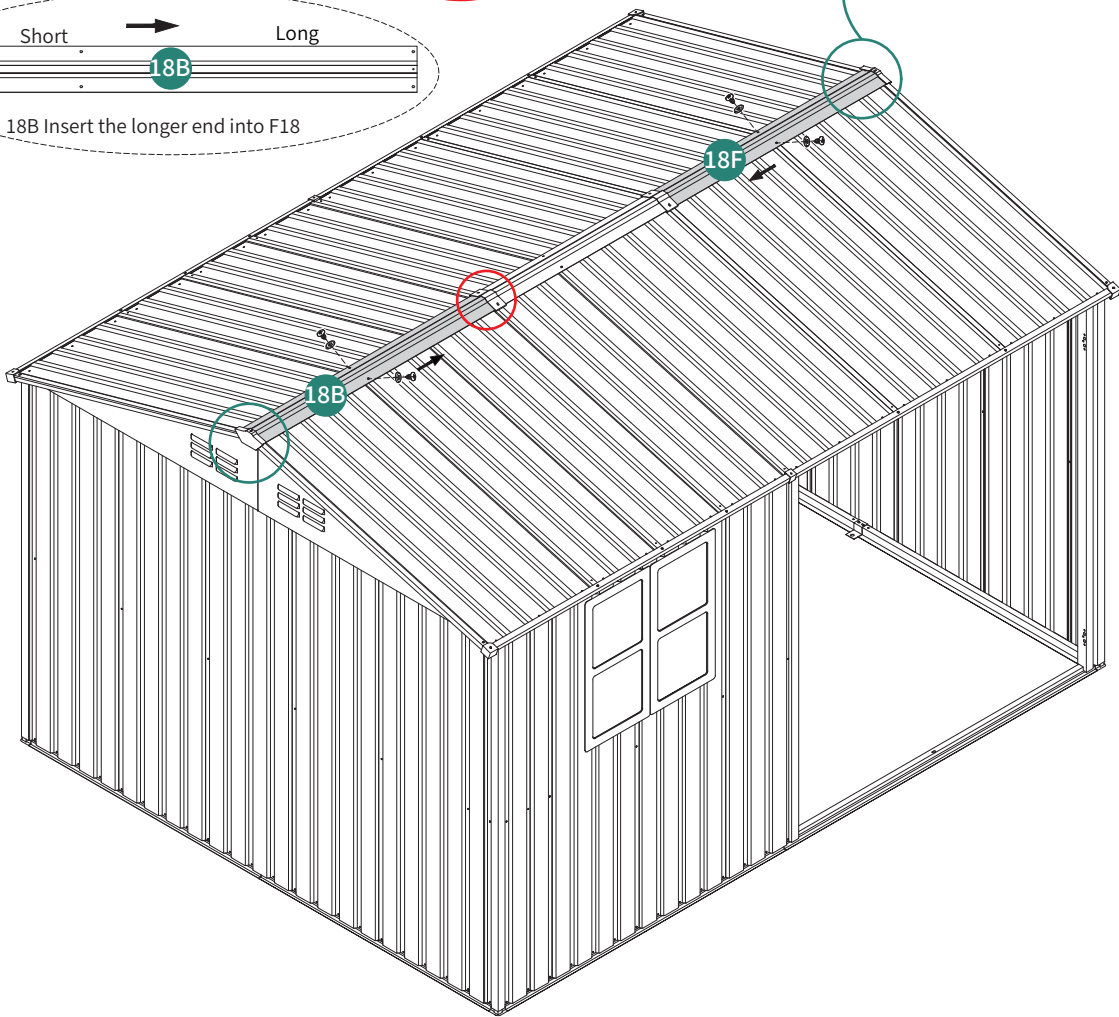
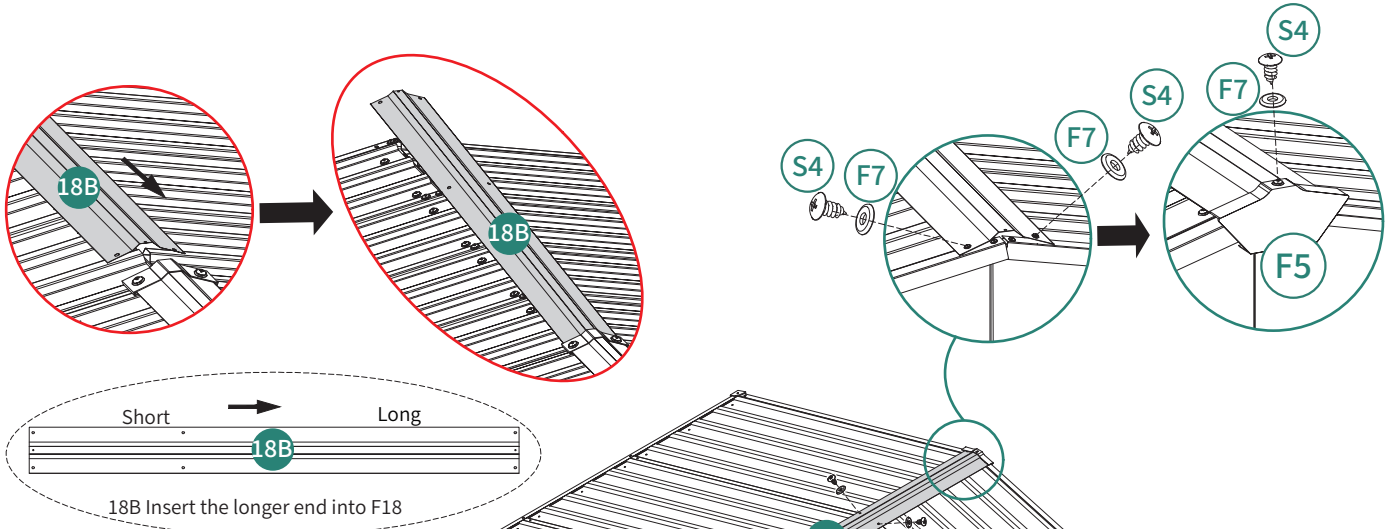

# 31

- 
- 15 2pcs
  - 16 1pc
  - 22 1pc
  - M1 1pc
  - S6 3pcs
  - S6A 3pcs
  - S7 6pcs
  - S1 1pc

Install part 16 to the side of part M1 (front side panel) with the longer distance from the center screw hole to the edge, and part 22 to the side with the shorter distance.

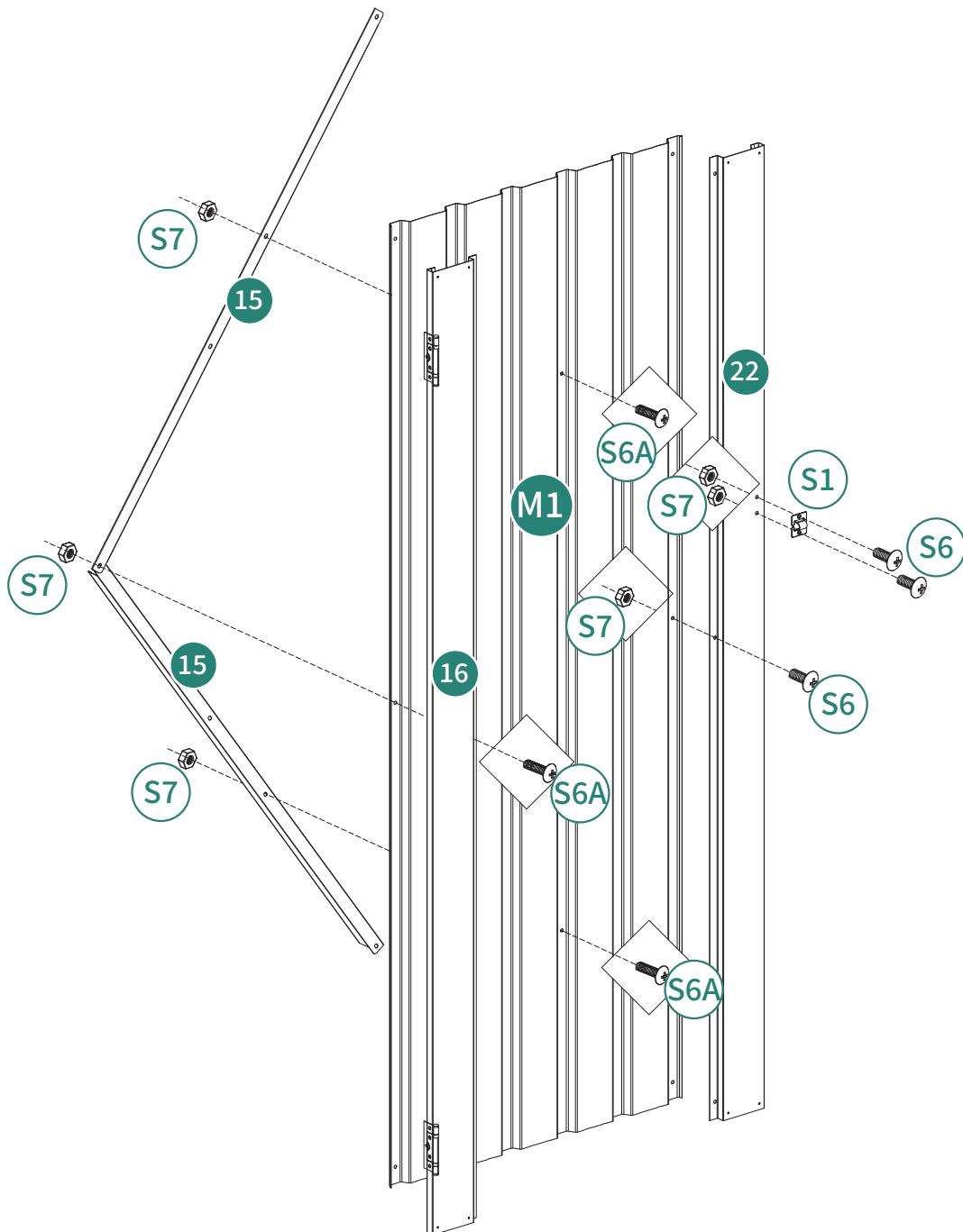

32



21 2pcs



S4 8pcs

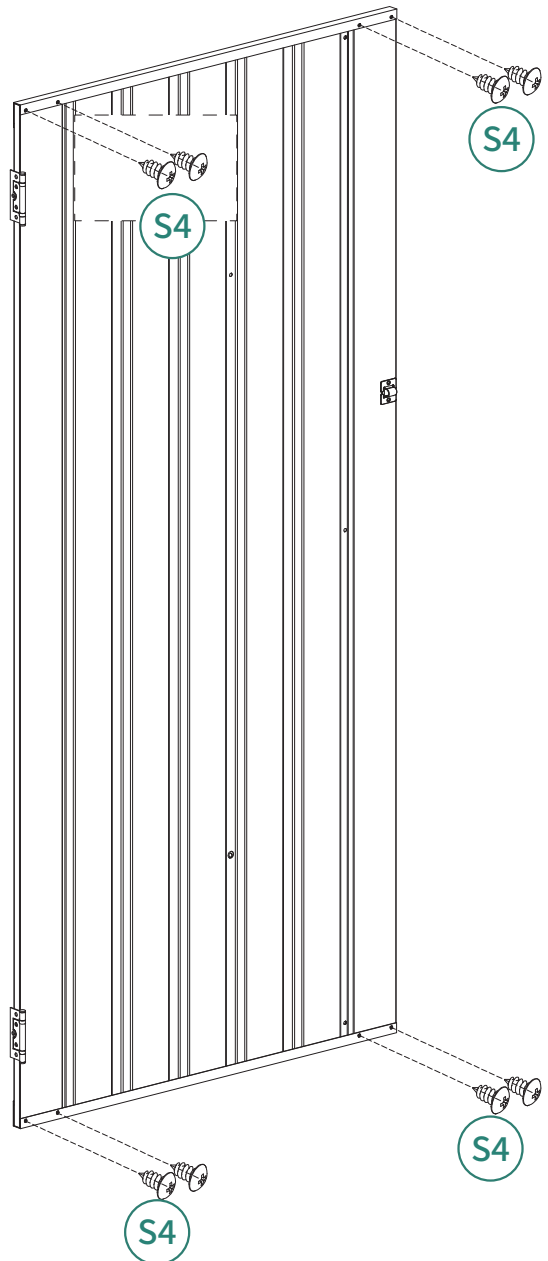
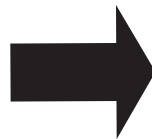
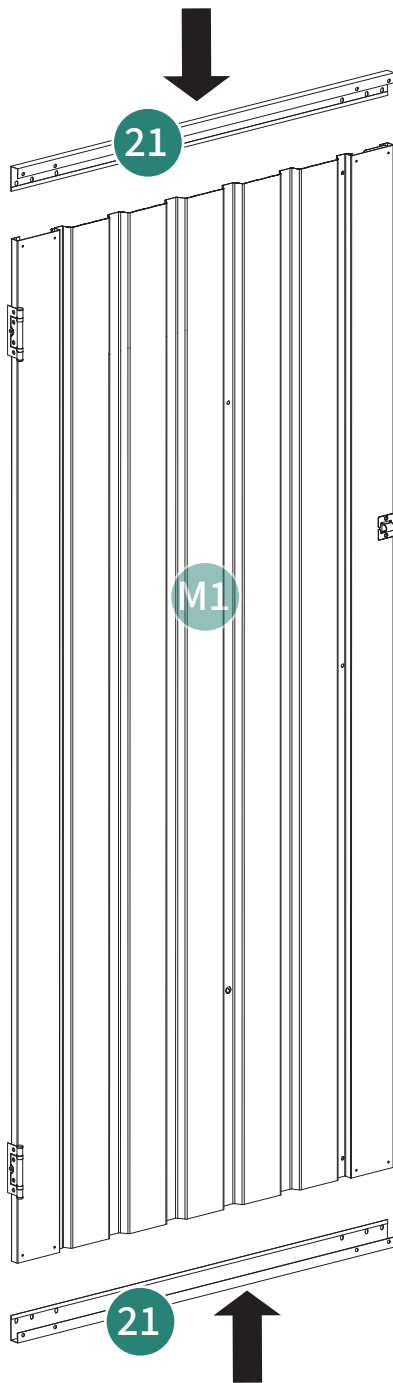

# 33



S4 2pcs

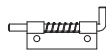

S5L 1pc

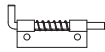

S5R 1pc



S6 6pcs



S6A 2pcs



S7 8pcs

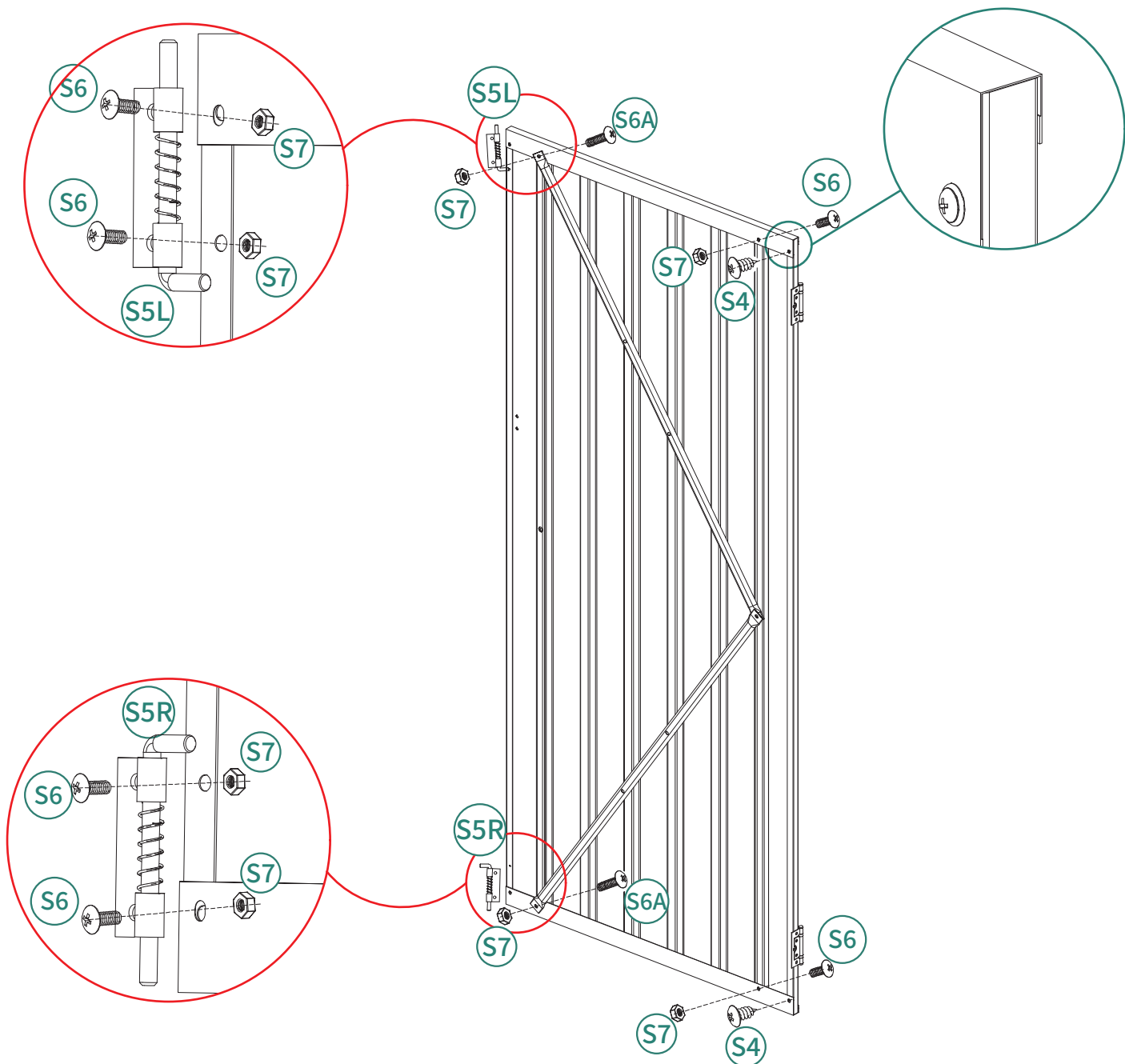

# 34

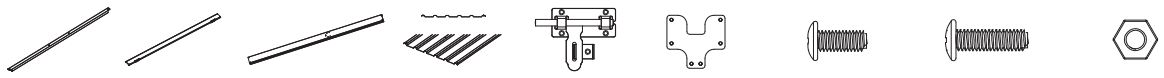
- 
- 15 2pcs
  - 16 1pc
  - 23 1pc
  - M1 1pc
  - S2 1pc
  - S3 1pc
  - S6 7pcs
  - S6A 3pcs
  - S7 4pcs

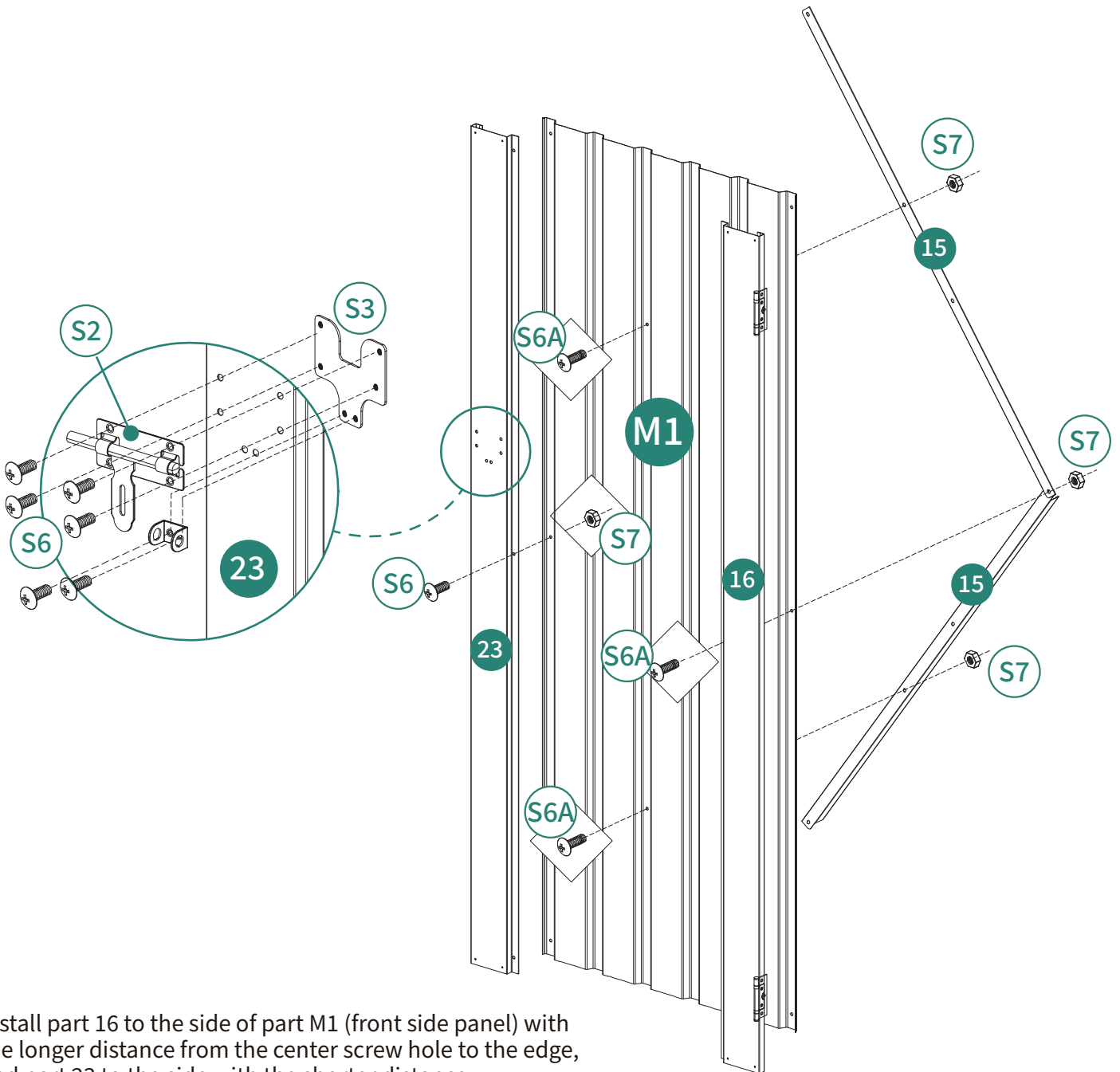

Install part 16 to the side of part M1 (front side panel) with the longer distance from the center screw hole to the edge, and part 23 to the side with the shorter distance.

35



21 2pcs

S4 8pcs

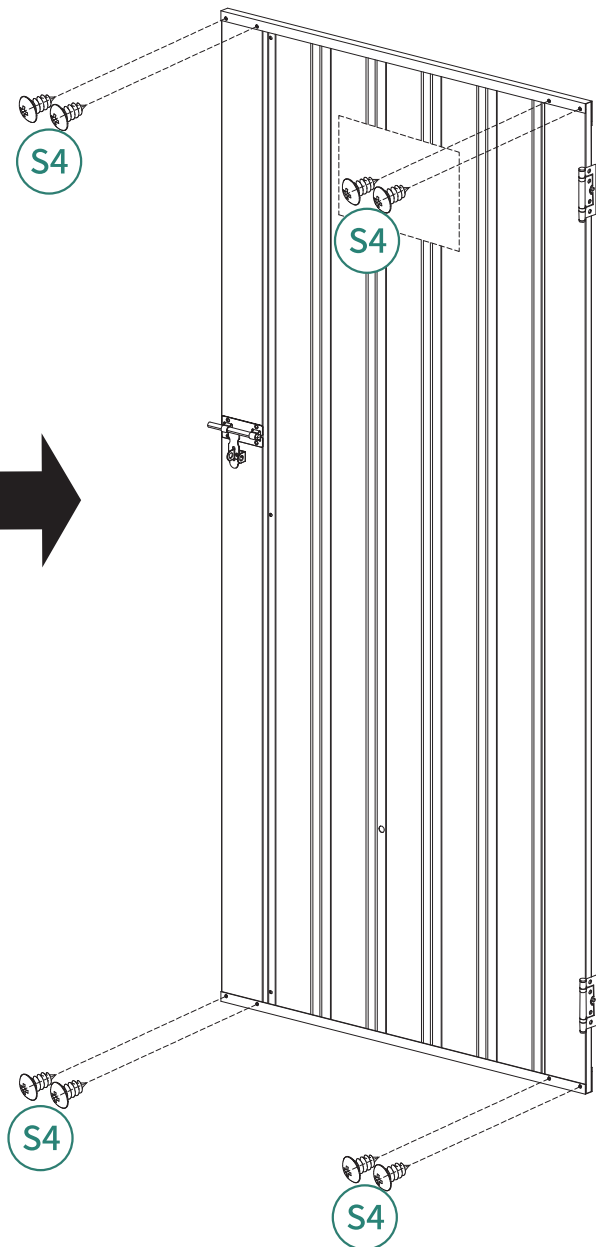
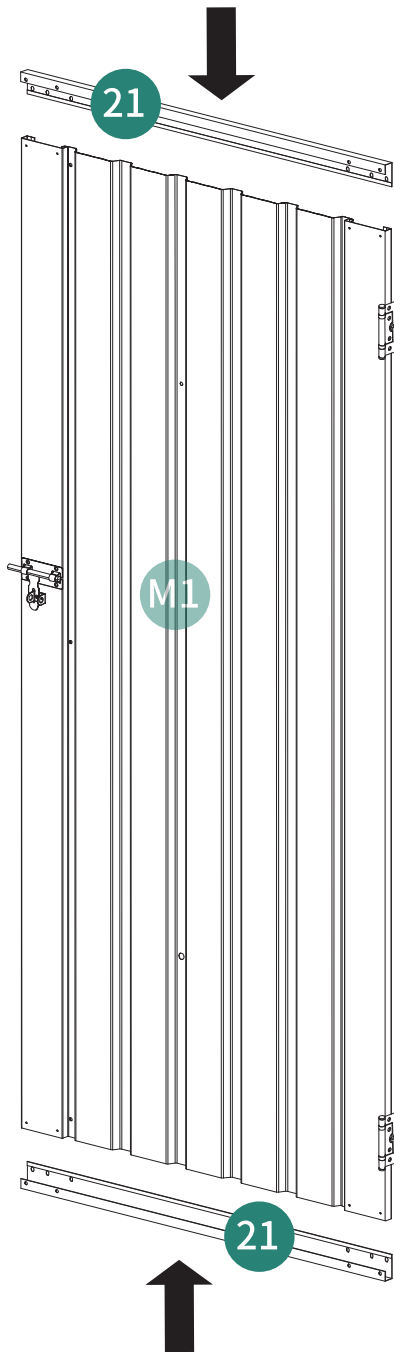

36



S4 4pcs

S6 2pcs

S6A 2pcs

S7 4pcs

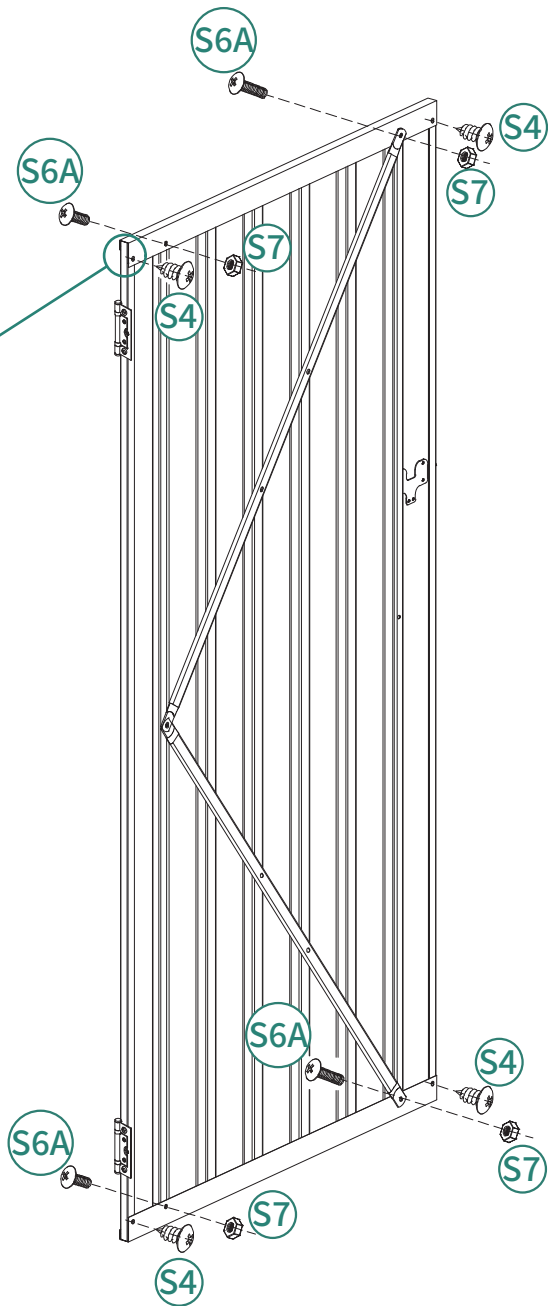
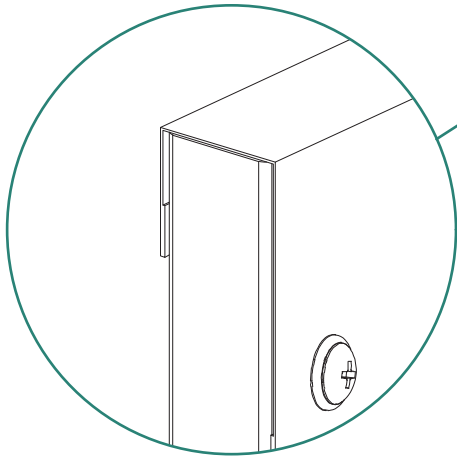

37



(S6) 12 pcs

(S7) 12 pcs

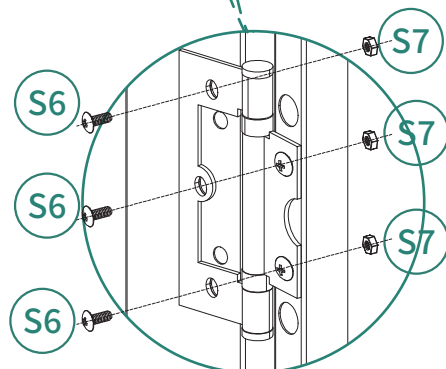
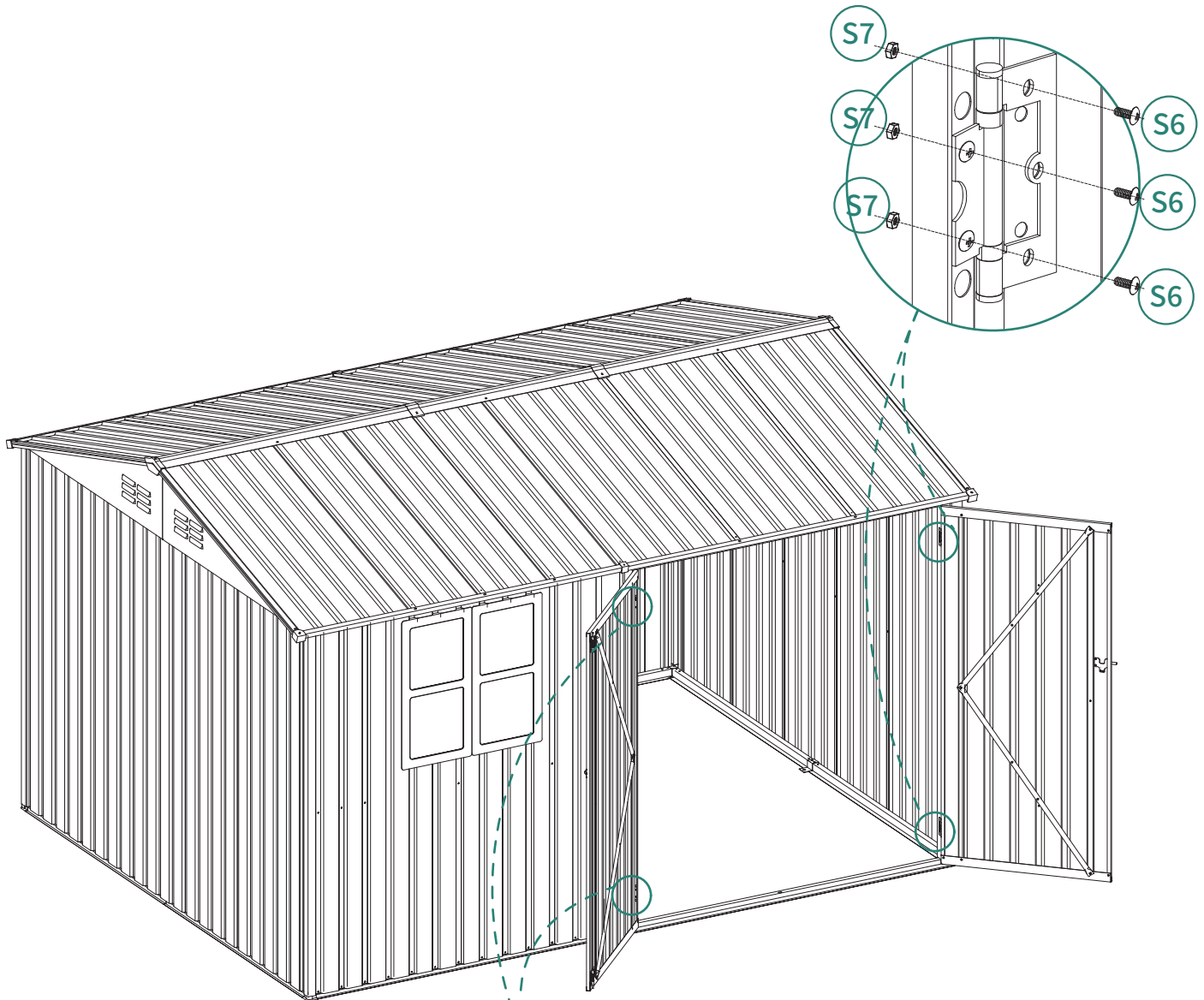

# 38



(S9) 4pcs

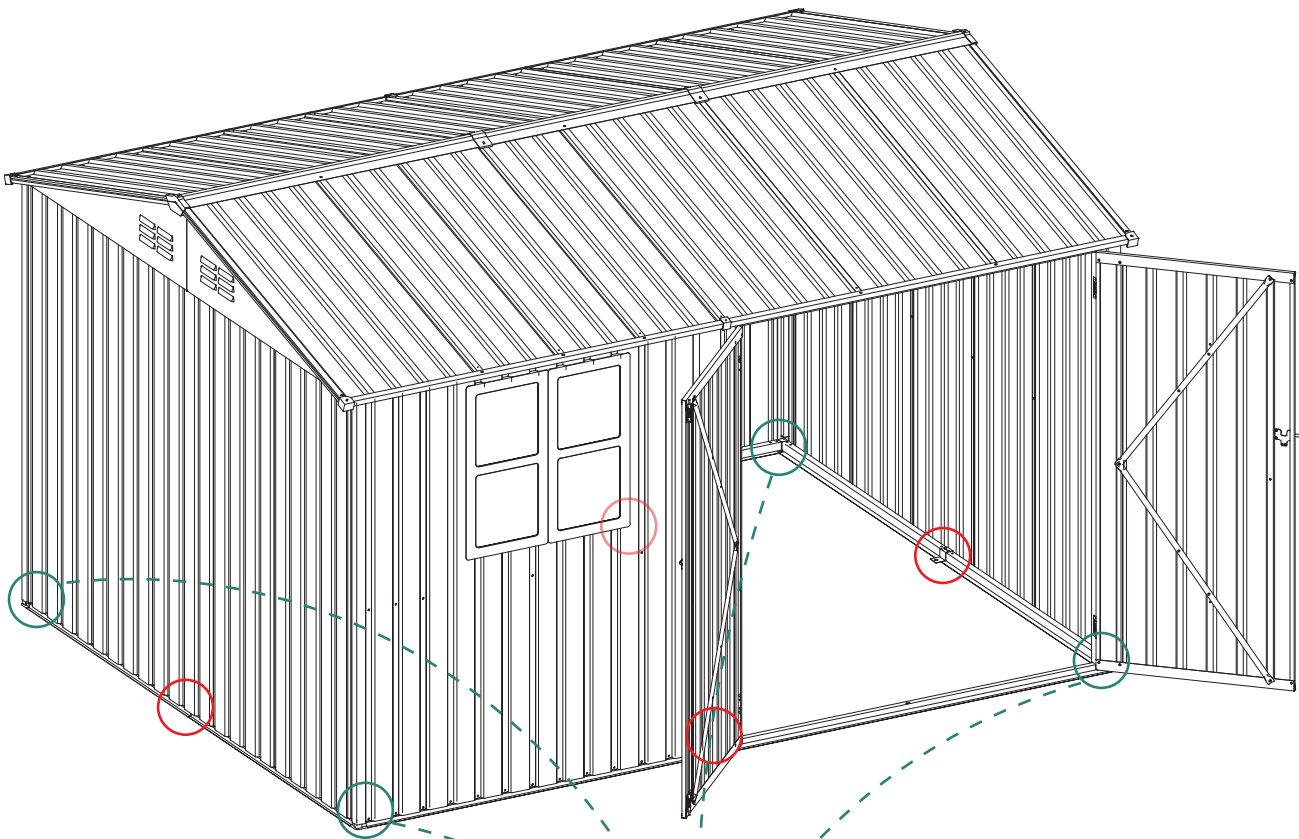

To improve the wind resistance, please be sure to complete this installation step. If expansion bolts or ground stakes are not installed, strong winds may cause the tool shed to collapse. Expansion bolts are crucial for the stability on concrete surfaces, and ground stakes are used for grassy areas. The accessory package includes the ground stake components, but the expansion bolts are not included.

The screws of the M6X50 must be hit at the joint of the floor beam to make it stronger.

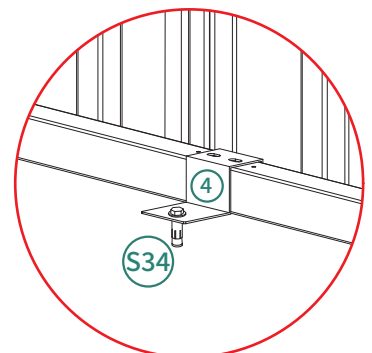
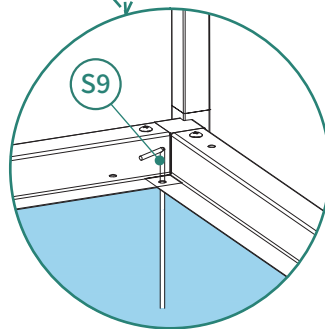

39

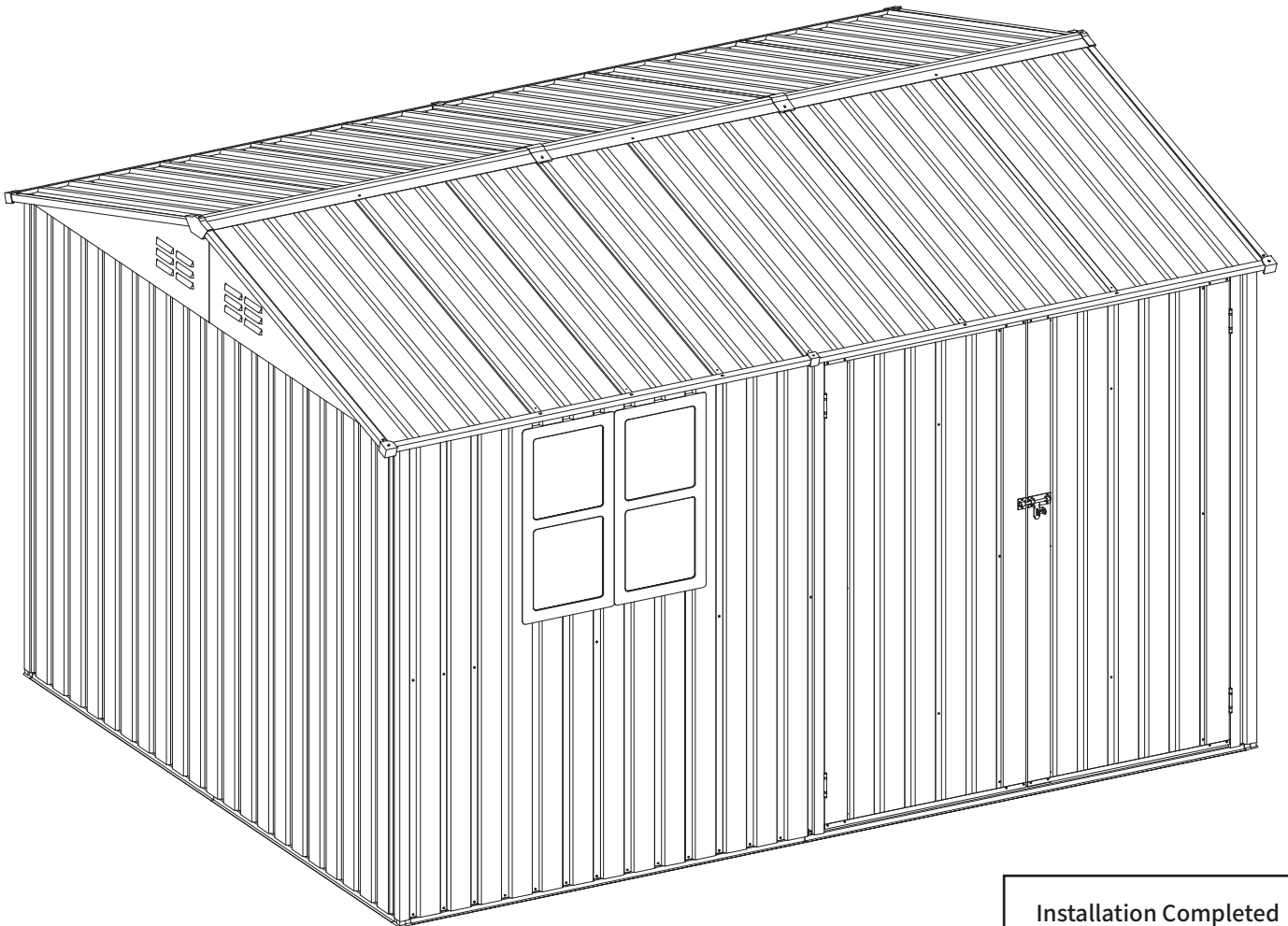

Installation Completed

Installation Abgeschlossen

Installation Complétée

Installazione Completata

Instalación Completada

# HELP CENTER



Inquiry



Assembly issue



Missing parts

If you encounter any difficulties during assembly, please contact us.

Wenn Sie während der Montage auf Schwierigkeiten stoßen, kontaktieren Sie uns bitte.

Si vous rencontrez des difficultés lors du montage, veuillez nous contacter.

Se incontri difficoltà durante il montaggio, ti preghiamo di contattarci.

Si encuentras alguna dificultad durante el ensamblaje, por favor contáctanos.

# DISCLAIMER

Manufacturer and seller expressly disclaim any and all liability for personal injury, property damage or loss, whether direct, indirect, or incidental, resulting from the incorrect attachment, improper use, inadequate maintenance, unapproved modification, or neglect of this product.

Der Hersteller und Verkäufer lehnen ausdrücklich jegliche Haftung für Personenschäden, Sachschäden oder Verluste ab, egal ob direkt, indirekt oder zufällig, die durch falsche Anbringung, unsachgemäßen Gebrauch, unzureichende Wartung, nicht genehmigte Änderungen oder Vernachlässigung dieses Produkts entstehen.

El fabricante y vendedor renuncian expresamente a toda responsabilidad por lesiones personales, daños materiales o pérdidas, ya sean directos, indirectos o incidentales, derivados de la incorrecta colocación, uso inadecuado, mantenimiento insuficiente, modificación no aprobada o negligencia de este producto.

Il produttore e il venditore declinano espressamente ogni responsabilità per lesioni personali, danni materiali o perdite, dirette, indirette o incidentali, derivanti dall'errato fissaggio, uso improprio, manutenzione inadeguata, modifica non autorizzata o negligenza di questo prodotto. Le fabricant et le vendeur déclinent expressément toute responsabilité en cas de blessures corporelles, de dommages matériels ou de pertes, qu'ils soient directs, indirects ou accessoires, résultant de la fixation incorrecte, de l'utilisation inappropriée, de l'entretien insuffisant, de la modification non approuvée ou de la négligence de ce produit.