

ASSEMBLY INSTRUCTIONS

Dining Table 84

Components

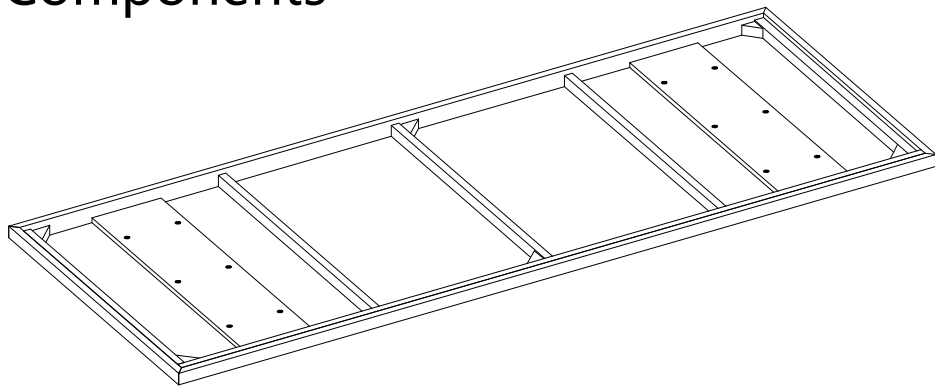

A Top×1

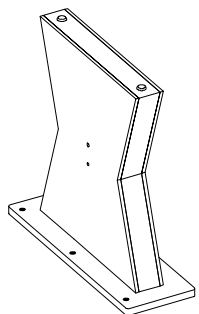



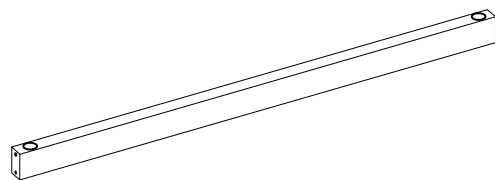





B Pier×2



C Center Beam×1

HARDWARE LIST

NO	DESCRIPTION		QTY
1		Allen Bolt M8×40 mm	12 pcs
2		Lock Washer M8	12 pcs
3		Flat Washer M8	12 pcs
4		Allen Key M8	1 pc
5		Dowel $\phi 10 \times 50$	2 pcs
6		Bolt M8×90 mm	2 pcs
7		Washer M8	2 pcs
8		Nut M8	2 pcs
9		Wrench M8	1 pc

Assembly Instruction

Note:
The floor must be covered with protective material so that the table top does not touch the floor directly.

Step 1

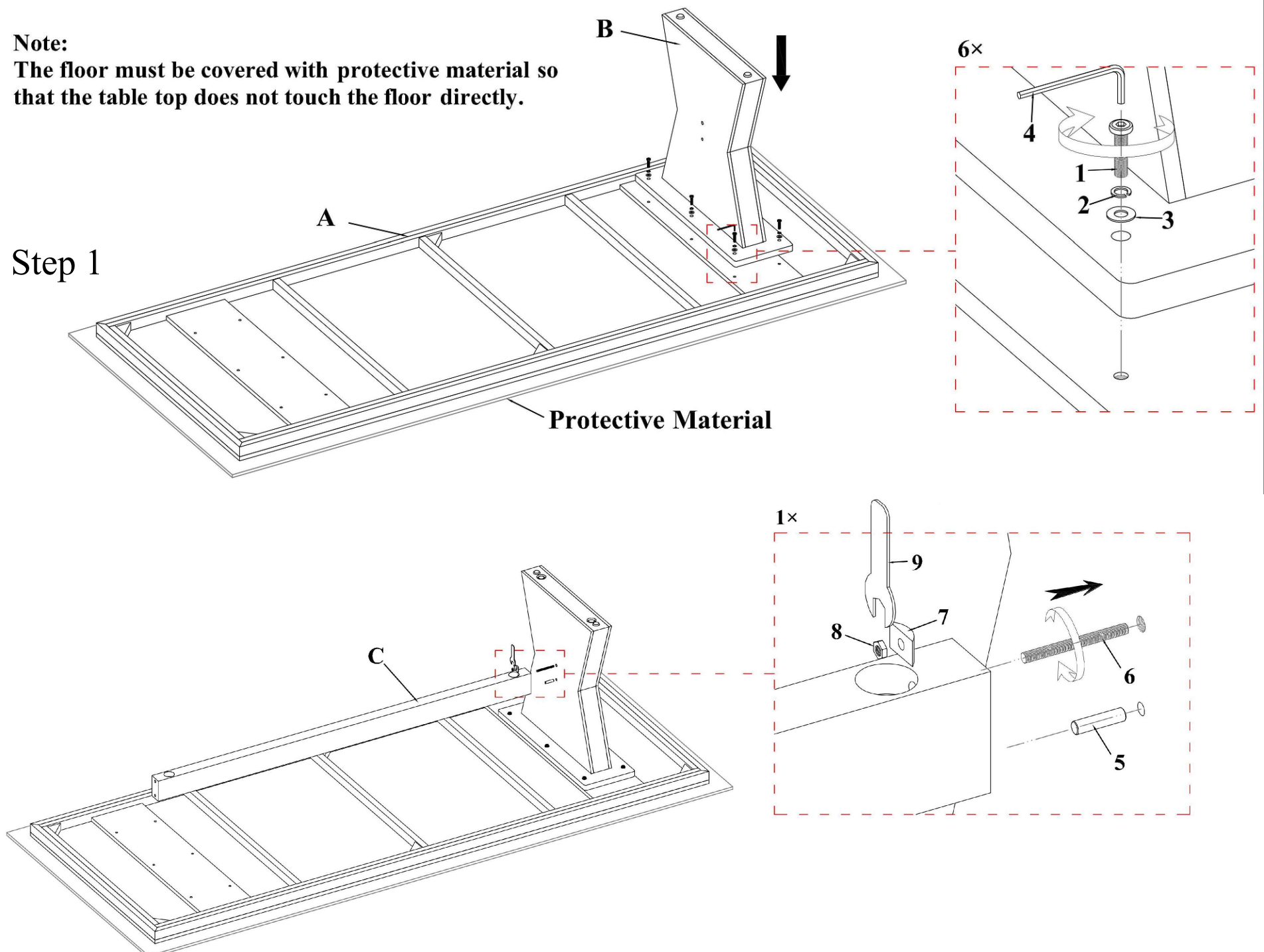

ASSEMBLY INSTRUCTIONS

Dining Table 84

Step 3

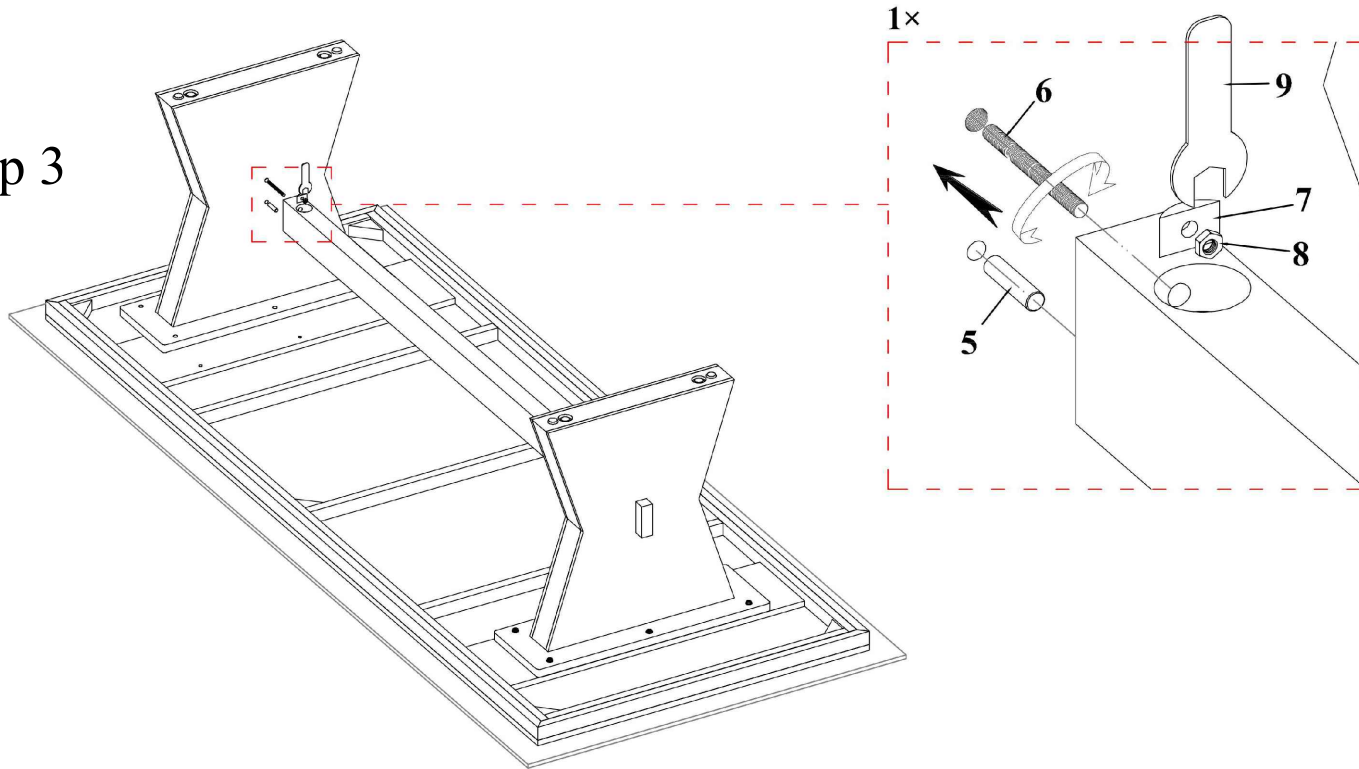

Step 4

