











## CARE AND MAINTENANCE

Wipe clean with a soft, dry cloth. The seat board can be cleaned with a mild cleaner. Test the cleaning method on a hidden area before using them over the entire area.

## NOTICE

- \* Please make sure that you have all parts indicated before you begin assembly of this item.
- \* This item should be assembled on a soft surface to prevent scratching the finished product during assembly.
- \* This item may require periodic tightening.
- \* Do not tighten bolts until completely assembled.

## Part List and Hardware List

Piece	Description	Picture	Quantity
A	HEADBOARD		1 X
B	LEG		2 X
C	FINIAL		2 X
H1	BOLT 5/16* 1-1/2"		4 X
H2	BOLT 5/16*2-3/4"		4 X
H3	WASHER		4 X
H4	SPRING WASHER		4 X
H5	UNT		4 X
H6	WRENCH		1 X
H7	ALLEN KEY 4MM		1 X

The hardware that is needed to connect the headboard to the bed frame is included. Please note that our headboard legs are compatible to most standard bedframes. Our headboards DO NOT include a mounting bracket.

Example of Mounting Bracket'



Product Dimensions: 61-1/4"W\*3-1/4"D\*53-3/4"H

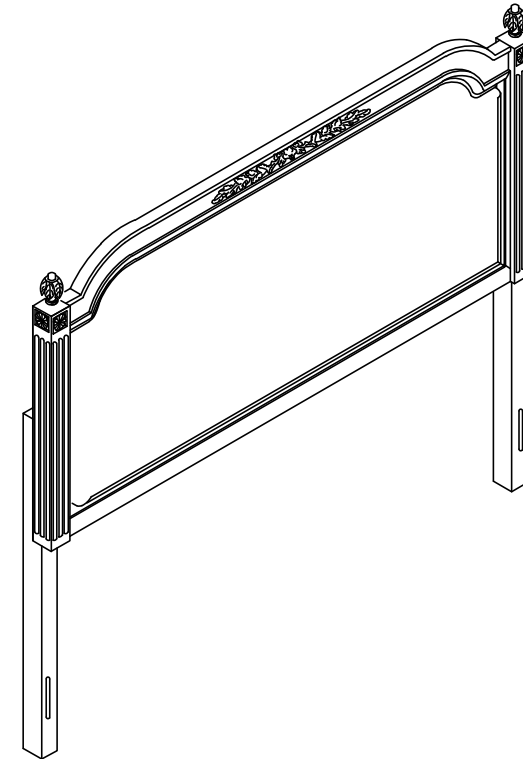

## PREPARATION

Before beginning assembly of product, make sure all parts are present. Compare parts with package contents list and hardware contents list. If any part is missing or damaged, do not attempt to assemble the product.

Estimated Assembly Time:10 minutes.

Tools Required for Assembly (included):Wrench.

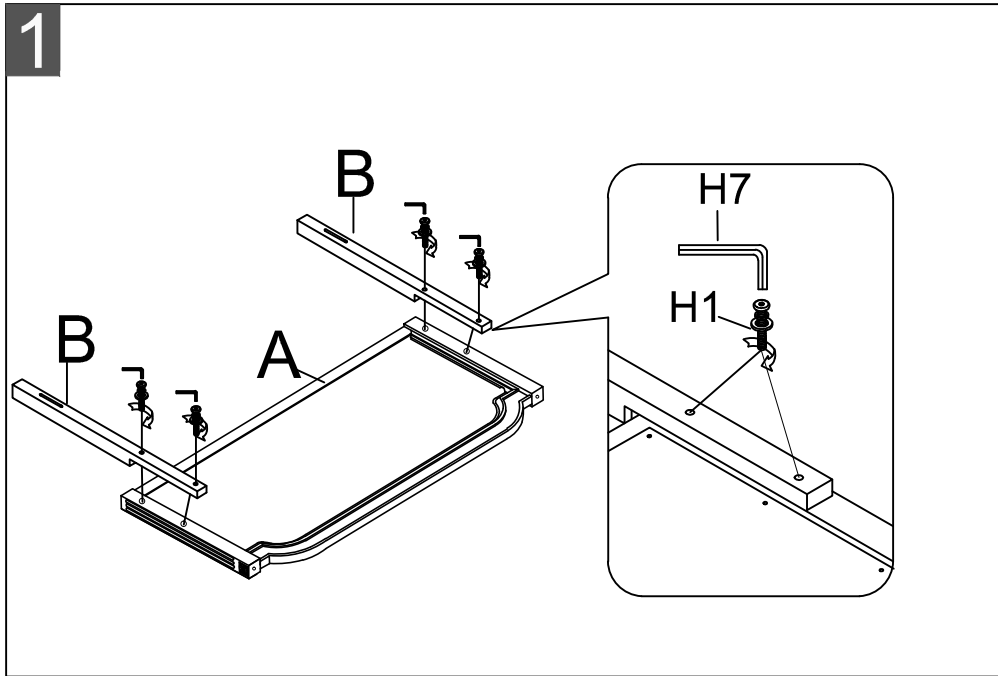

Step 1:  
Attach leg (B) to headboard (A) by using Allen key (H7) to lock with 4\*bolts (H1).

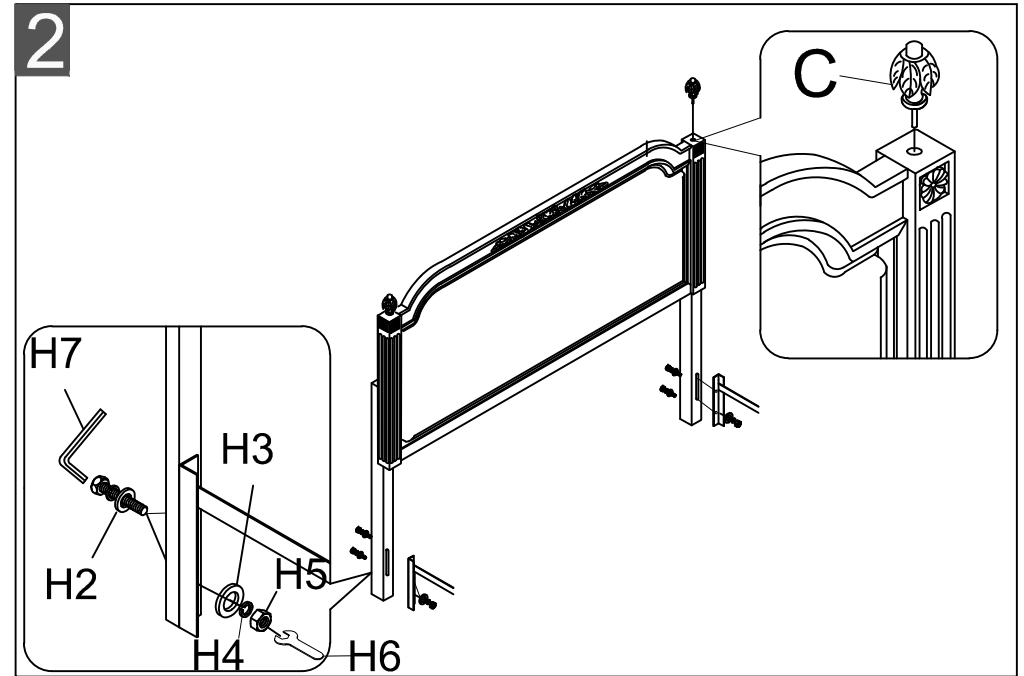

Step 2:  
Assemble Metal Bed Frame ((END-USER PREPARED NOT INCLUDED)) to leg (B) by using Wrench (H6) & Allen key (H7) with the enclosed parts of 4\*bolts (H2) , 4\* washers (H3) ,4\*spring washers (H4) & 4\* nuts (H5) . Attach 2 finials (C) on top of L/R headboard (A).