



2-in-1
Face&Hair Steamer
User Manual

Safety Precautions and Warning

To ensure proper operation of this appliance, please read all the safety precautions carefully before use. The safety precautions are provided to help you with the correct and safe operation of this appliance so that you may avoid injuries to yourself and others as well as damage to property. The safety precautions are defined as follows.

Specification parameters

| | |
|-------------------|---|
| Rated Voltage | 110V <input type="checkbox"/> / 220V <input type="checkbox"/> |
| Electric Power | 350W |
| Rated Frequency | 60HZ <input type="checkbox"/> / 50HZ <input type="checkbox"/> |
| Water Capacity | 400ML |
| Steam Temperature | about 40°C (20cm away from the nozzle) |
| Water Type | Distilled Water or Purified Water |

Warning

- Do not use this product near a full bath, sink, or any humid vessel.
- Do not use the appliance by persons who are unable to feel heat. Doing so may result in burns or scalding.
- Immediately stop using if you experience any pain or abnormalities on your skin or throughout your body.
- The following persons should not use the product:
 - a. Women who are pregnant or currently in a menstrual period, it may cause skin problems due to hormone imbalance.
 - b. Persons who have allergies, skin diseases, atopic dermatitis, sensitive skin or persons who suffered serious sunburn.
 - c. Persons with skin injuries, eczema, swelling, etc.
 - d. People who recently had physical surgery.
- When plugging the plug, do not touch any metal part on the plug.
- Turn off the power and pull out the plug from power outlet when you are not using product. Failure to do so may cause fire.
- Periodically clean to avoid dust accumulation. The moisture and other factors may cause insulation failure.
- Do not wrap the power cord around the appliance, doing so may cause deformation malfunction of the cord.
- Always ensure the appliance is operated on an electric power source matched to the rated voltage indicated on the appliance. Ensure that the plug and appliance plug are plugged in completely. Failure to do so may result in fire, electric shock, burns or scalding.
- Do not plug or unplug the plug in to power outlets and using the appliance with wet hands, doing so may result in electric shock or fire due to insulation deterioration.

Warning

- Do not use the appliance under the following conditions.
 - a. When the cord or plug is damaged or becomes hot.
 - b. When the plug is loose in the power outlet.
 - c. Do not damage, modify, unreasonably bend, pull or twist the cord.
 - d. Do not place anything heavy on the cord and do not pinch the cord.
 - e. Do not let other object or dirt get attached to the end of plug.
- Do not use or store the appliance in bathroom or in other rooms with high humidity, doing so may result in electric shock or fire due to insulation deterioration.
- Do not allow infants to use the appliance, do not allow a child to lick the appliance plug, doing so may result in burns, electric shock or scalding. Do not use the appliance near flammable substances (alcohol, thinner, benzene, enamel remover, aerosol sprays, etc.), doing so may result in explosion or fire.
- Do not immerse the appliance in water. Use the water tank to supply water to the appliance.
- Do not drop or hit the appliance. If this appliance sustains damage from being dropped or hit, please do not continue to use it.
- Do not insert objects in the steam outlet, and do not block the steam nozzle, doing so may result in electric shock.
- Do not attempt to disassemble, or repair the appliance. Please contact the store where that appliance was purchased or an authorized service center for repairs, doing so may result in electric shock or fire.

Caution:

- When disposing of the water after use, wait until water cool off, hold the appliance so that your hands are not exposed to the hot water.
- Use only distilled water or purified water, failure to do so may result in equipment malfunction, or in serious cases, burns or scalding.

Facial Steamer



Name of Product Component

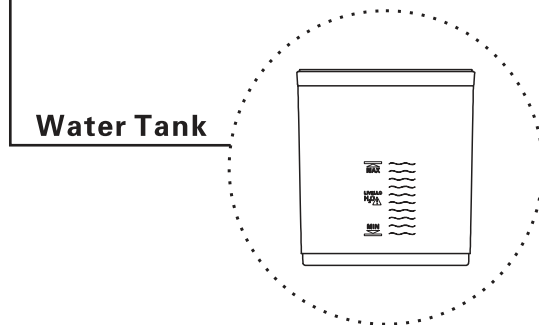
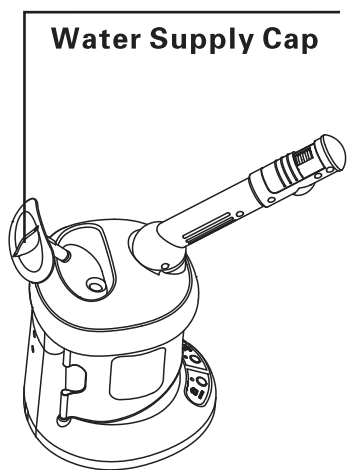
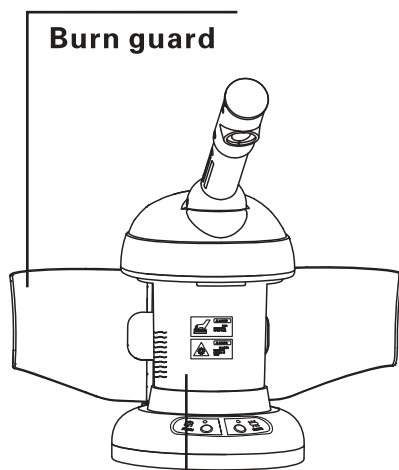
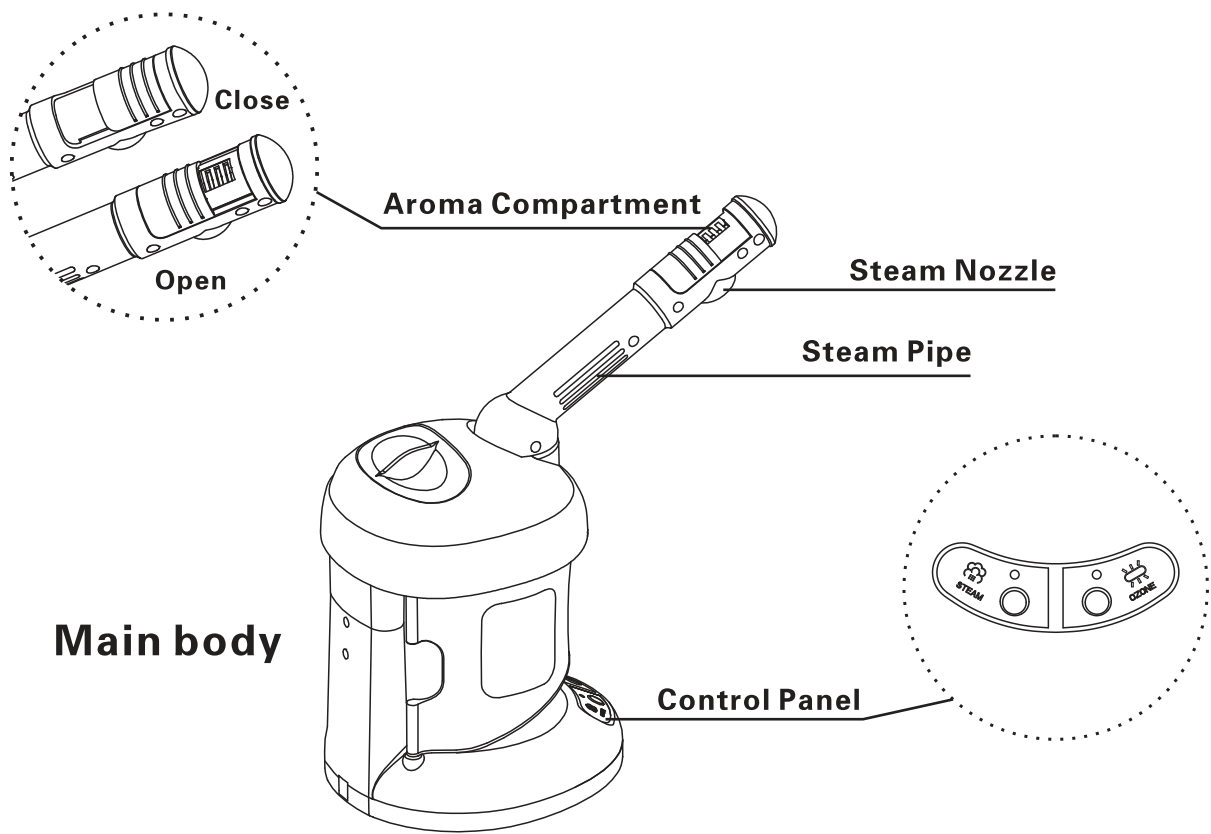

Preparation

- When you open the package at first time, you may see residual water in the water tank. This is the water left by quality inspection in the factory and it will not cause any hygienic issue.

Step 1 : Place the main unit on a flat level surface, such as table.

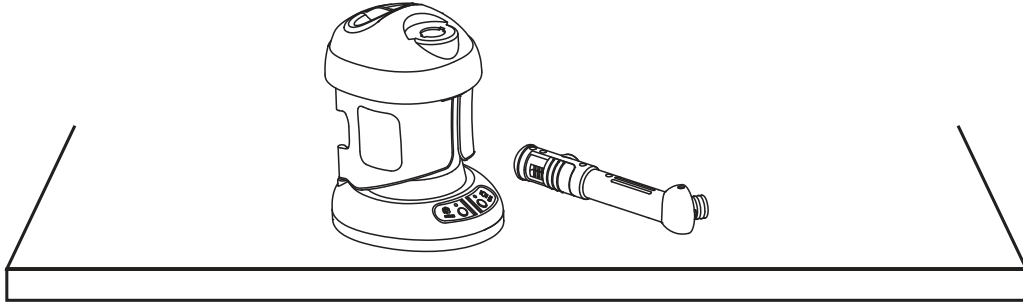

Step 2 : Install the steam pipe onto the unit, as per the below diagrams. Make sure the humps and slots are perfectly aligned.

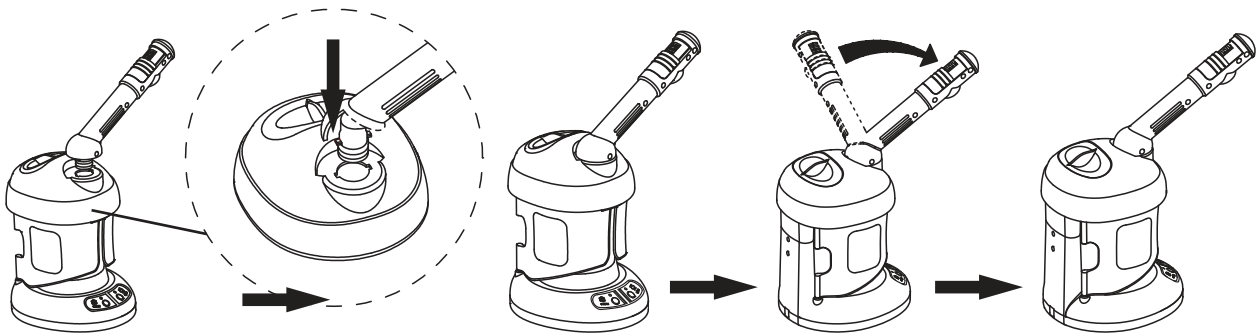

Step 3: Open the water supply cap, fill the water supply tank with water. Make sure the water level does not exceed the MAX mark.

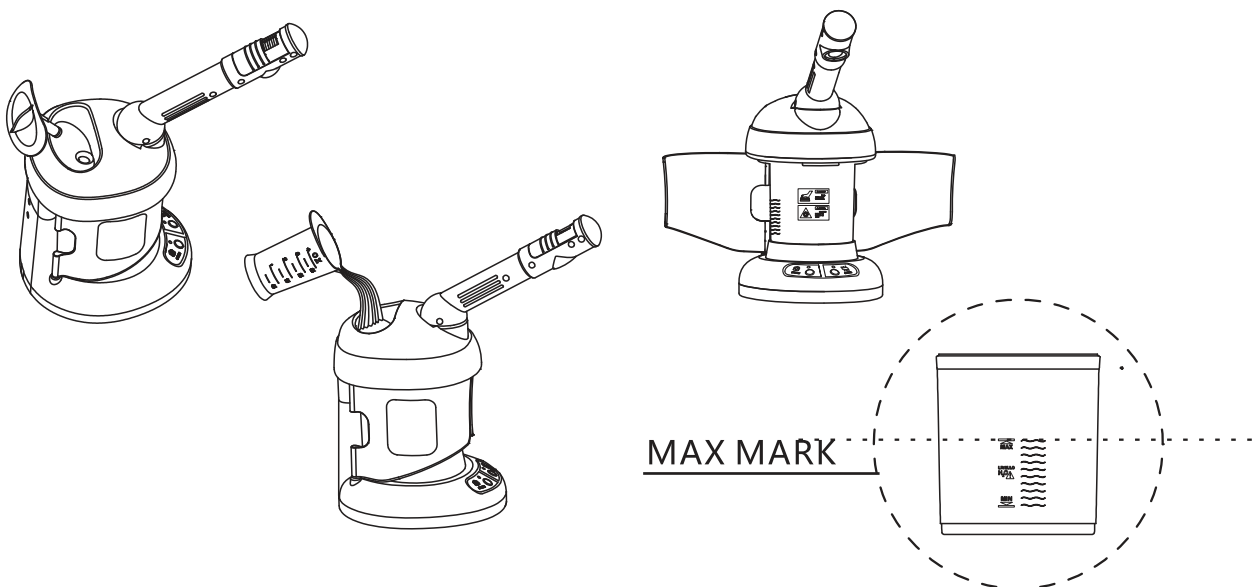

- Please use distilled water or purified water.
Since the service life of the appliance may shorten depending on water quality, the use of distilled or purified water is highly recommended.
- The following types of water cannot be used due to high mineral content. Tap water, Mineral water, Geothermal water, Acidulated water, Groundwater, Ionized Alkaline water.
- Do not mix the water with any other substance, such as lotion, aromatic oil, etc. Doing so may cause burns, malfunctions, or shorten the life of the main unit.

User Guide

1. Plug in the plug into the power outlet, and the appliance will beep indicating it enters standby mode.

2. Turn on the appliance by pressing "STEAM" button, simultaneously red LED Indicator will illuminate. Steam will be released after 5-7 minutes depends on water volume. Please notice when the steam begin to release from nozzle, it is normal that small amount of hot droplet spills out at the beginning.

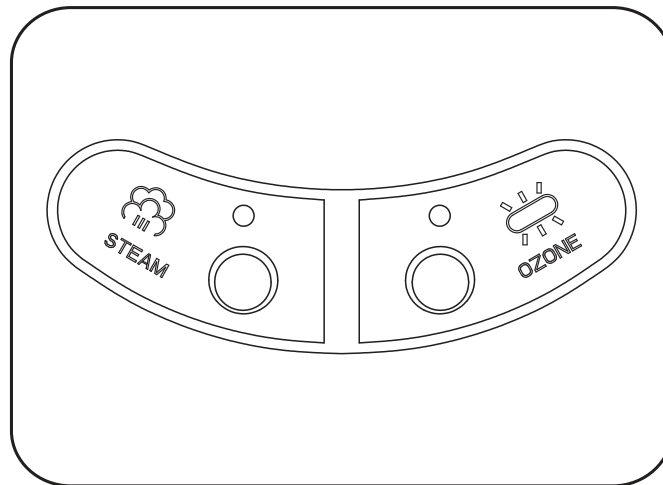

3. Turn on the ozone/ion function by pressing "OZONE" button, simultaneously red LED indicator will illuminate. The appliance will then create ozone and ion, thicken the steam. To start the steam and ozone functions at the same time, simply press the "OZONE" button at the standby mode.

4. Steam Care Guide

① Keep your face at least 20cm from the nozzle. To ensure that the steam covers your entire face.

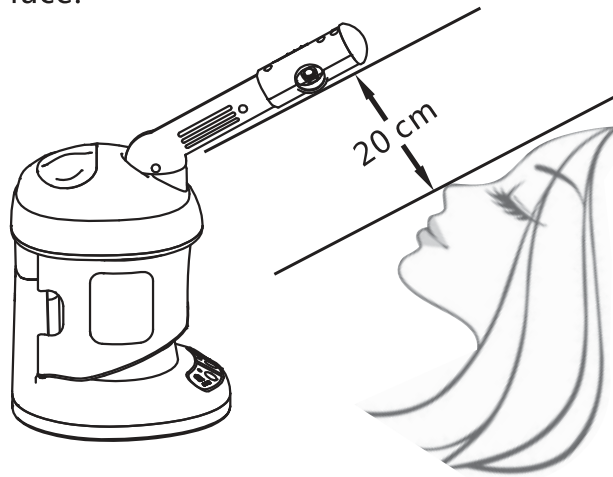

② Steam will be released about 5-7 minutes after appliance turns on.

③ The appliance will beep and automatically switch to standby mode for 3 minutes when water tank has insufficient amount of water, the LED indicators will flash instead of illuminating. If water is filled up within 3 minutes, the appliance will restart automatically. Otherwise, if the water is filled up after 3 minutes, user needs to press the "STEAM" button again to start the appliance.

For safety reason, the unit will not restart until water is refilled. Caution : Be aware of the hot temperature when refilling water, do not touch the water tank when observing the water level.

5. Aroma therapy

Open the aroma compartment, drop essential oil on the felt, close the compartment. The steam will then sent the aroma out.

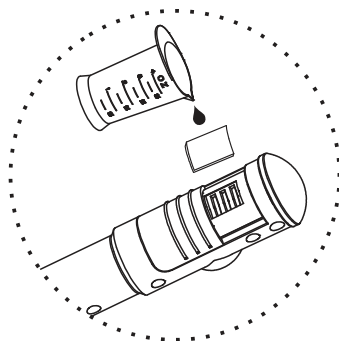

6. After Steam Care

Shut down the appliance by pressing the "STEAM" button. It is necessary to take care of your skin by moisturizing with lotion, performing cleansing, etc. Otherwise, water will evaporate from skin and cause dryness.

Cleaning and Maintenance

1. Clean once a month. Remove the plug from the power outlet and wipe away any dust using a dry cloth.

2. If scale is noticed in the water tank, fill up the water tank with approximately 400ml water and one spoon of vinegar. Turn on the unit by pressing "STEAM" button to let the water boil, then turn off the appliance and let it cool off. After approximately 12 hours, discard the vinegar water and rinse the tank with clean water.

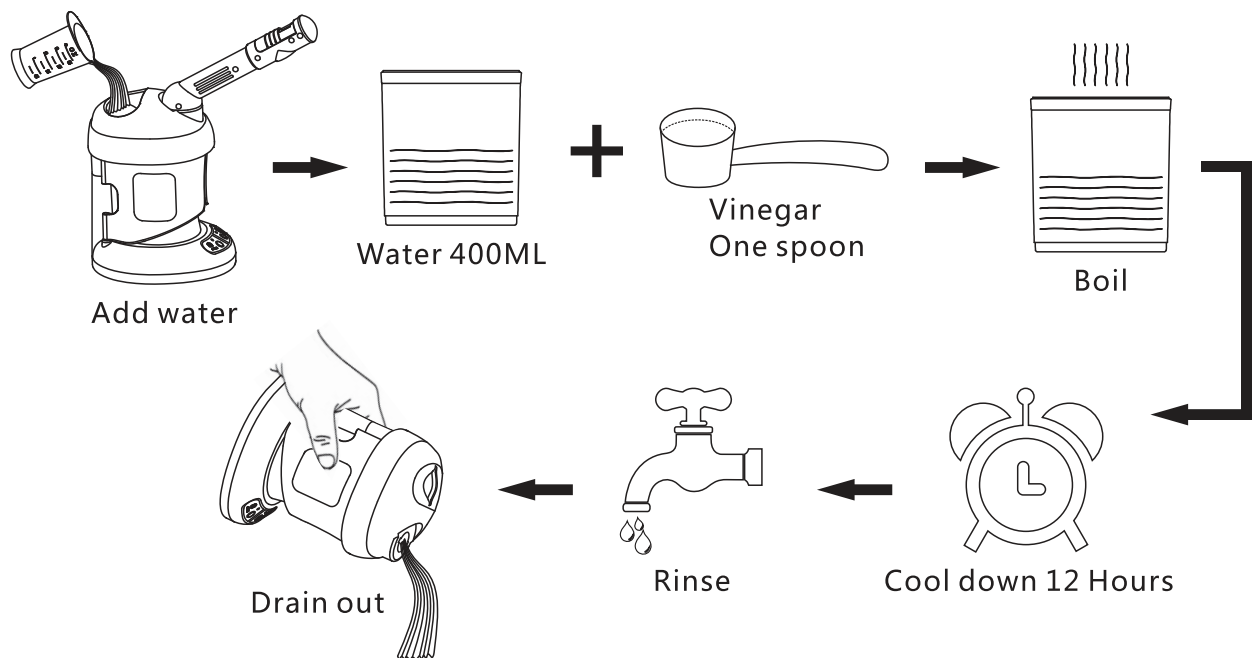

Warning regarding your skin

- Excessive use is detrimental to the skin.
- Initially, the appliance should only be used once a day, and no more than 10 minutes.
- Use 2-3 times a week for normal skin, once a week for sensitive skin.
- If the skin feel uncomfortable during use, please stop immediately.
- Basic skin care is required after using the steam, otherwise the steam may cause the moisture in your skin to evaporate easily, drying out your skin.