

8-Cube Storage Organizer

Instruction Manual

SG-GS8

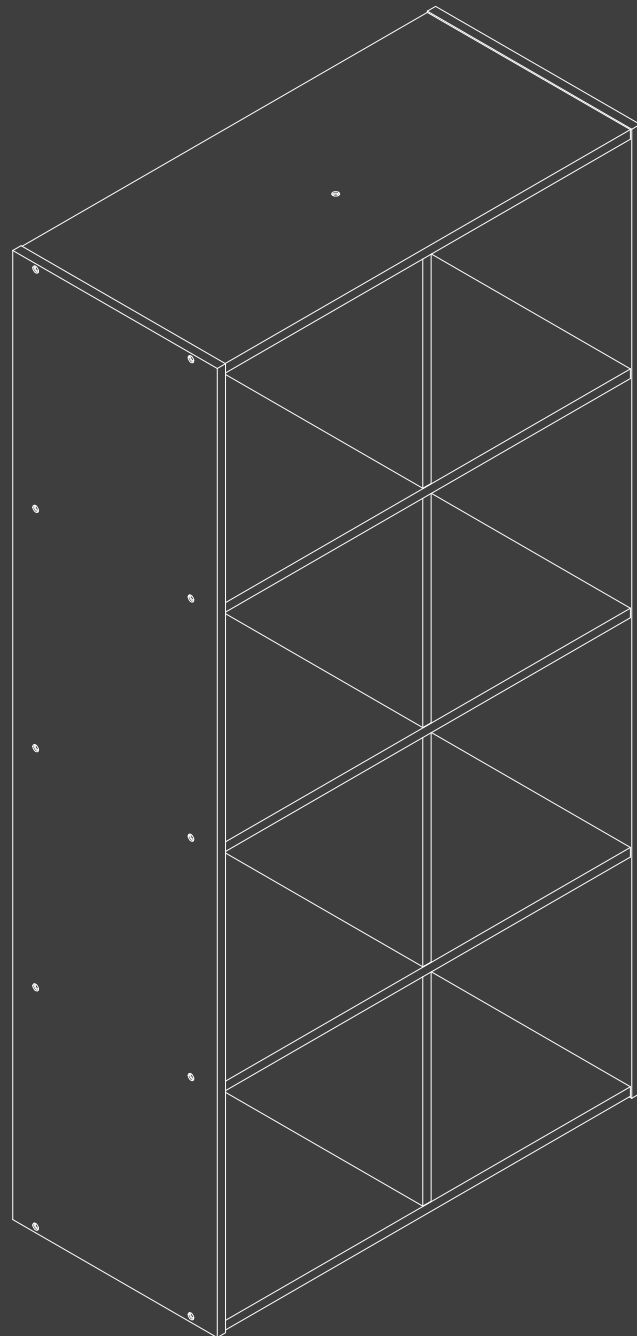

 EST 9:00AM--17:00PM

 HJ-Customer-Service@outlook.com

 (909)637-7665 | (909)637-7593

1 Hardware Identification

1 Screw

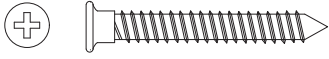

x22

1-1/2"(silver)

2 Nail

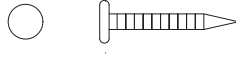

x48

5/8"(silver)

3 Cover sticker

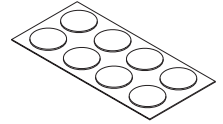

x3

4 Wooden dowel



x4

Ø6*30mm

5 Wooden dowel

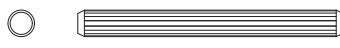

x6

Ø6*60mm

6 Washer

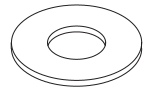

x1

7 Furniture tipping restraint kit

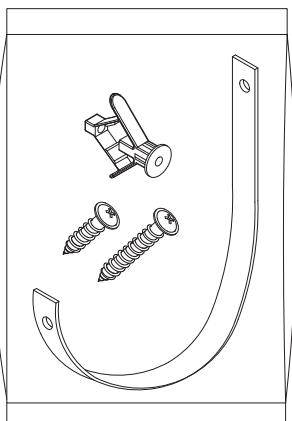

x1

8 Triangular handle screwdriver

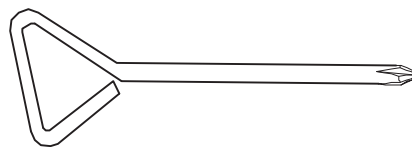

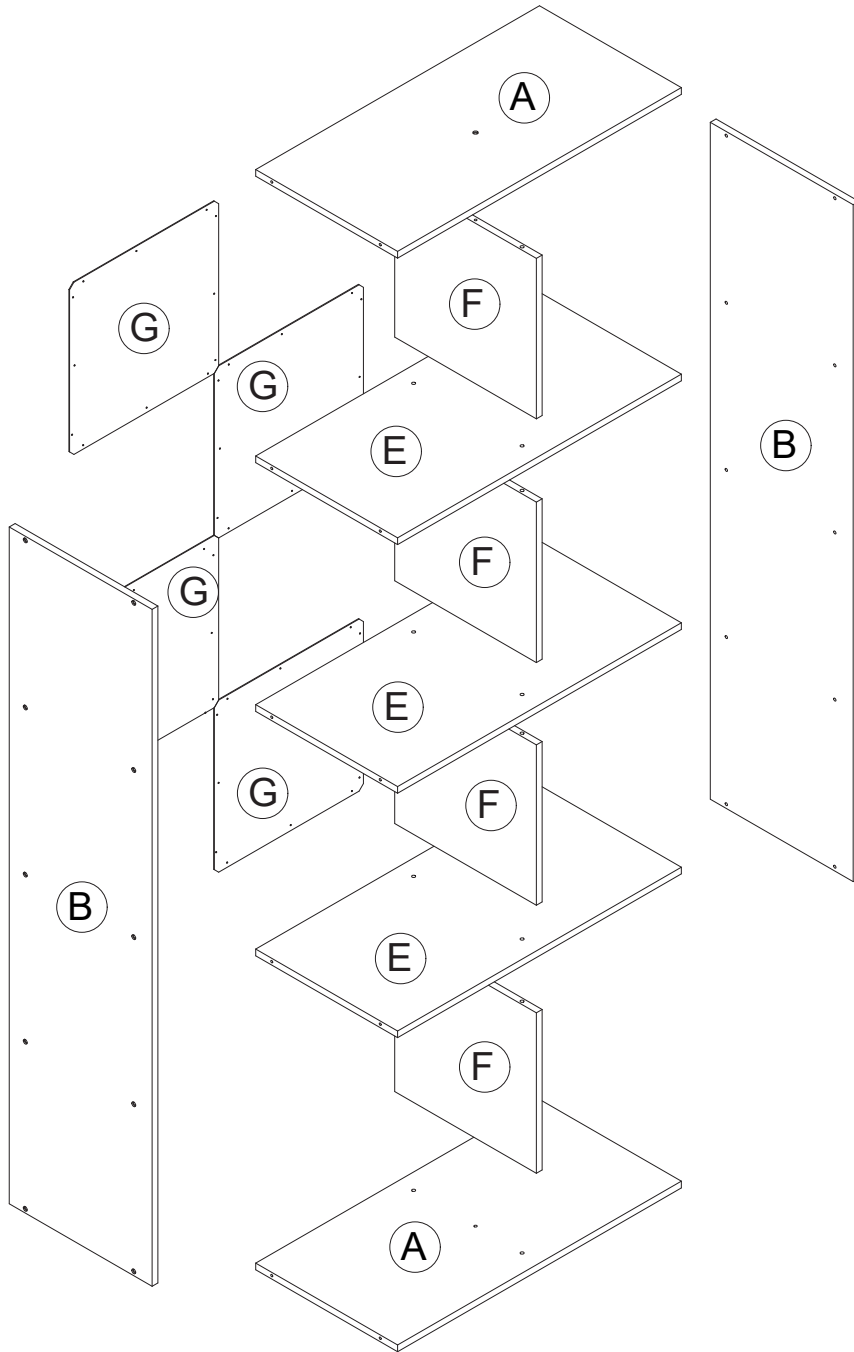

x1

2 Exploded View

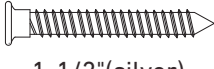
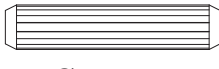

Step 1

 1-1/2"(silver)	 Ø6*30mm	
1 *2	4 *4	8 *1

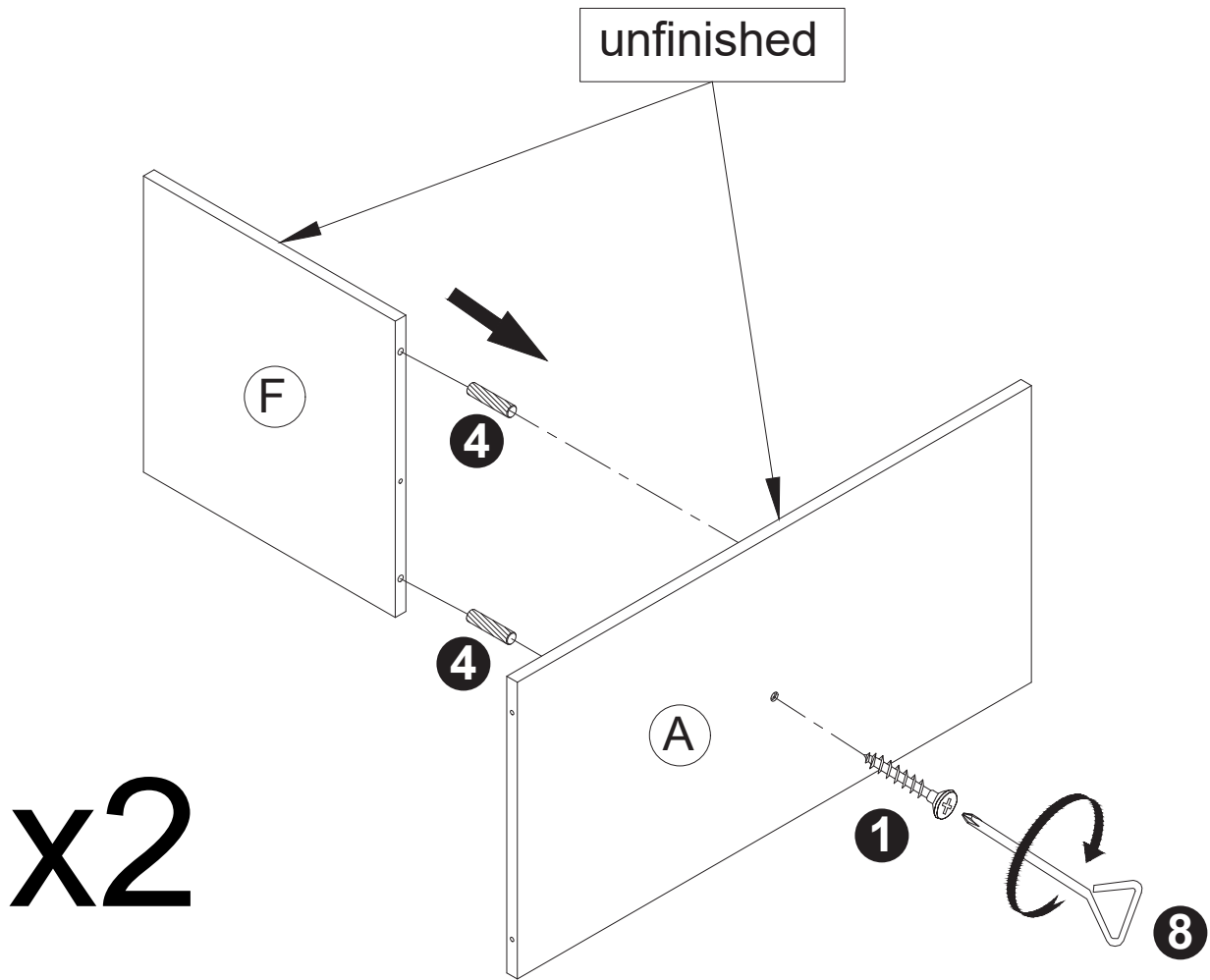

Step 2

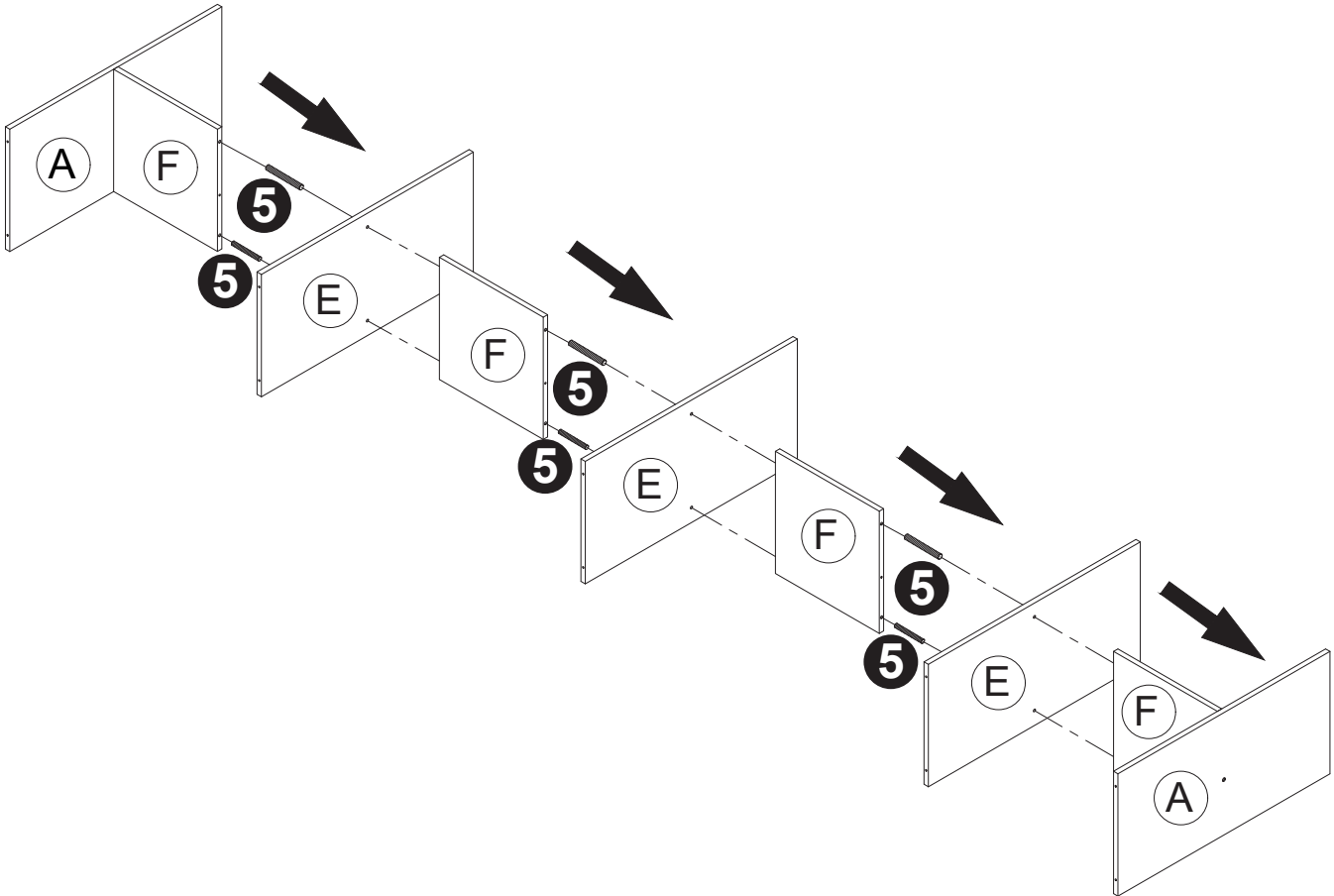
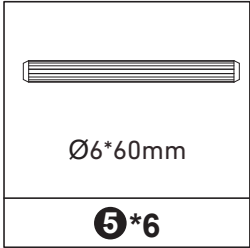

Step 3

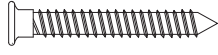
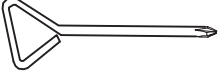
 1-1/2" (silver)	
1 *20	8 *1

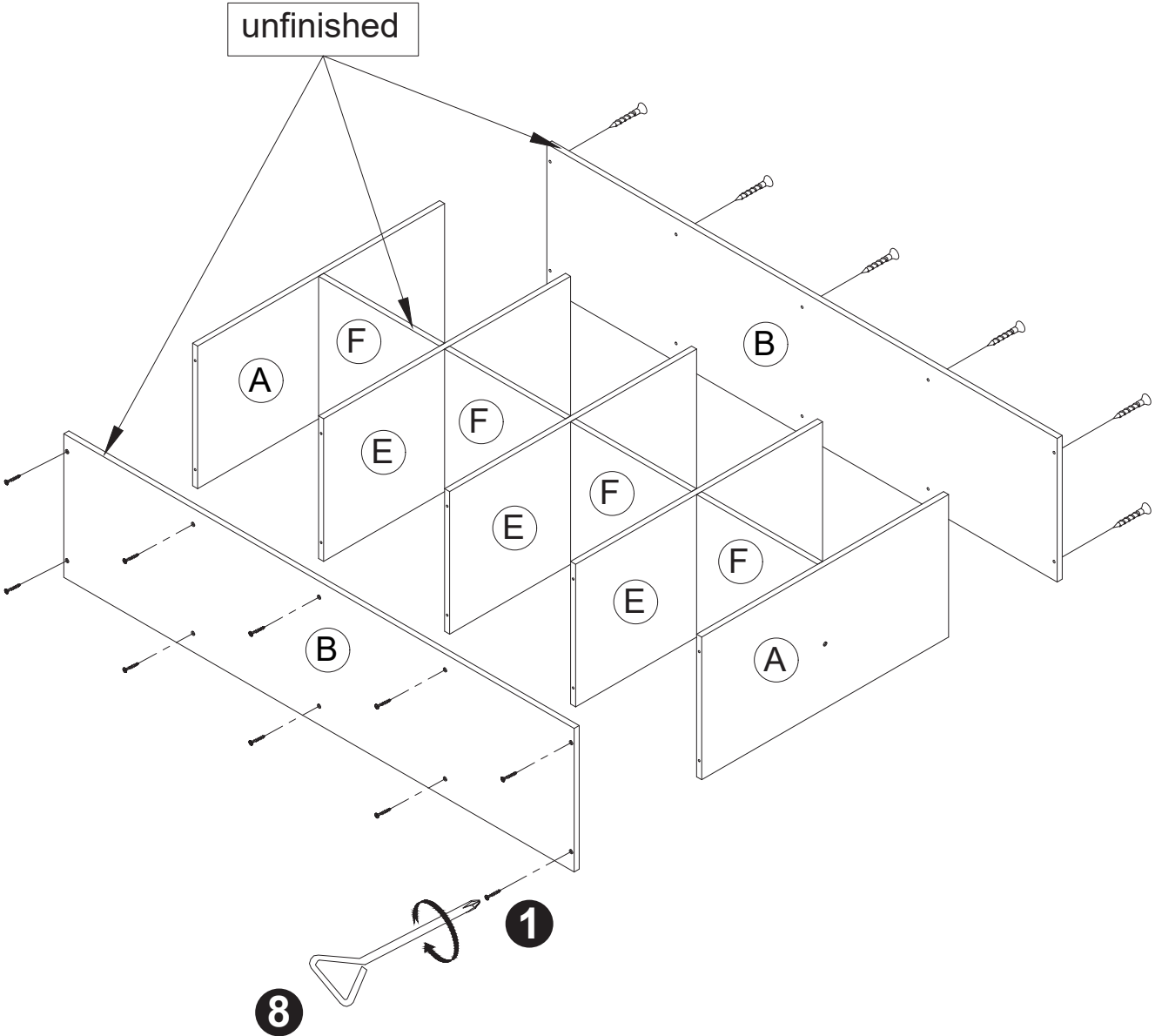

Step 4

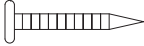
 5/8"(silver)
2 *48

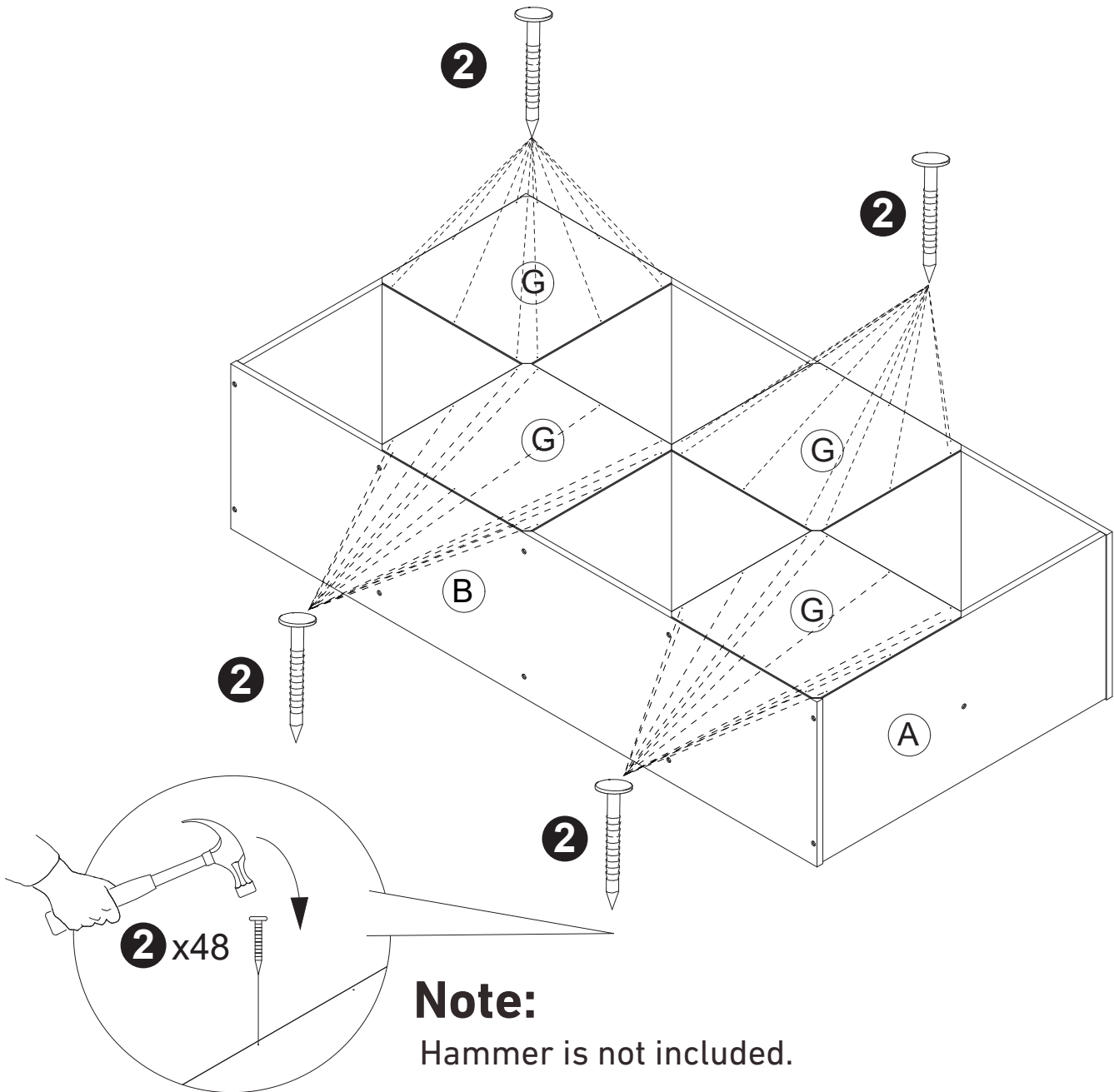

Note:

The position of panel (G) can be adjusted according to personal preference, but we recommend installing it as shown for greater stability.

Step 5

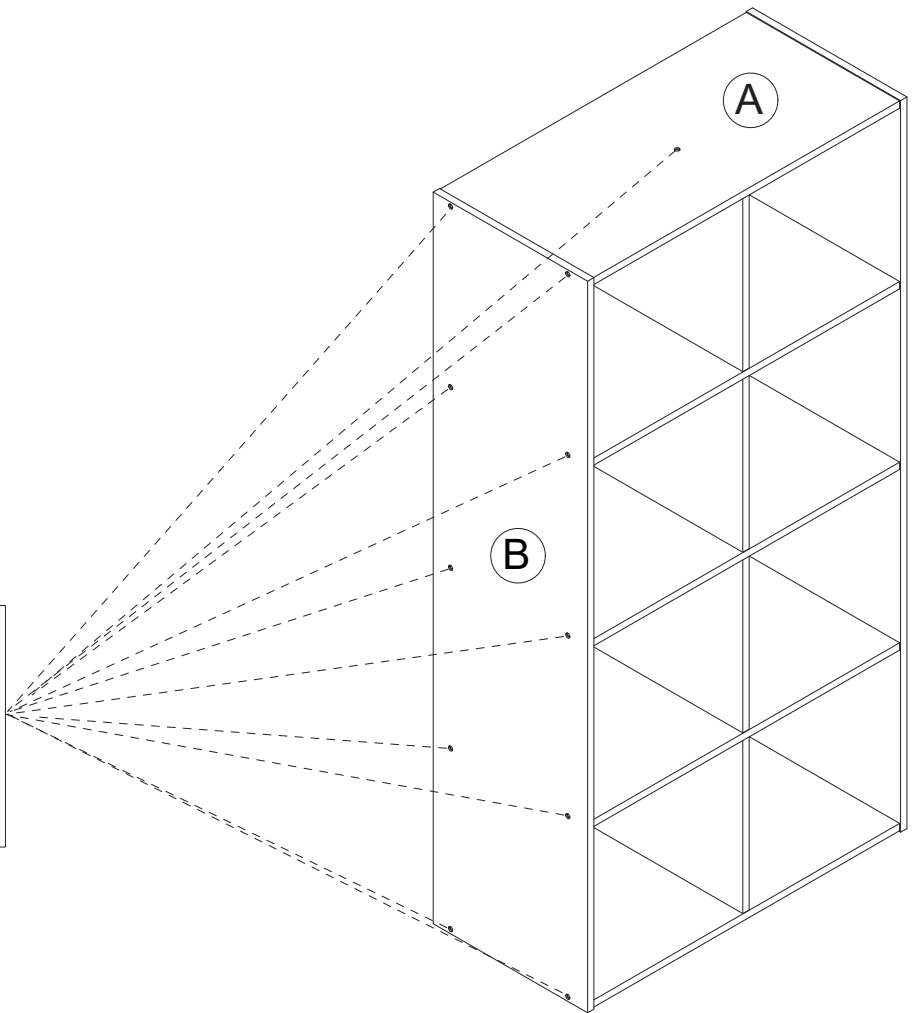
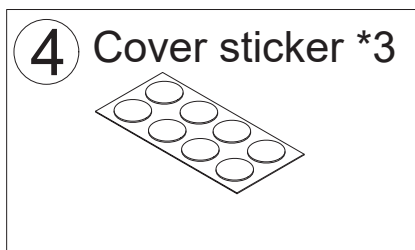

Apply the cover stickers to hide the screw heads.

Step 6

Option A:

- ① Mark the corresponding spot on the wall where the strap will be attached.

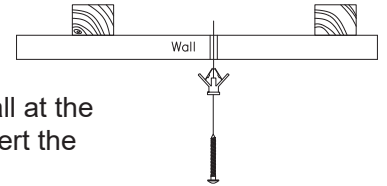
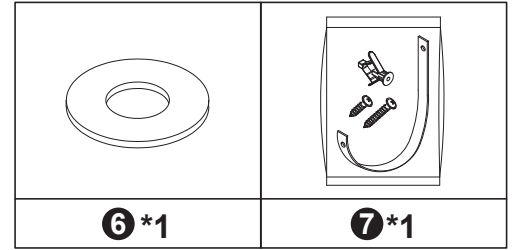
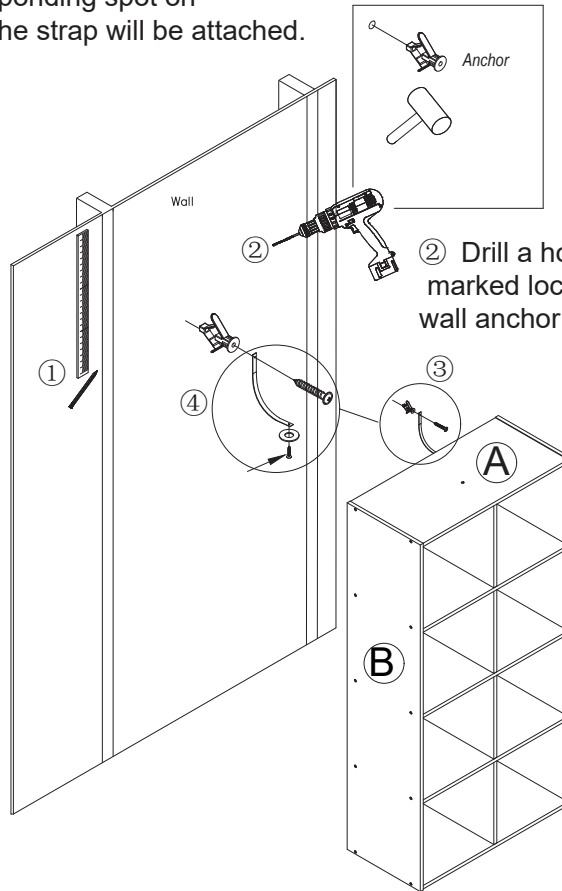

- ② Drill a hole into the wall at the marked location, and insert the wall anchor.

- ③ Use the LONG SCREW to secure the strap directly into the wall anchor. Tighten firmly with a screwdriver.

- ④ Use the washer and SHORT SCREW to secure the other end of the strap to the underside of the top panel (A).

Option B:

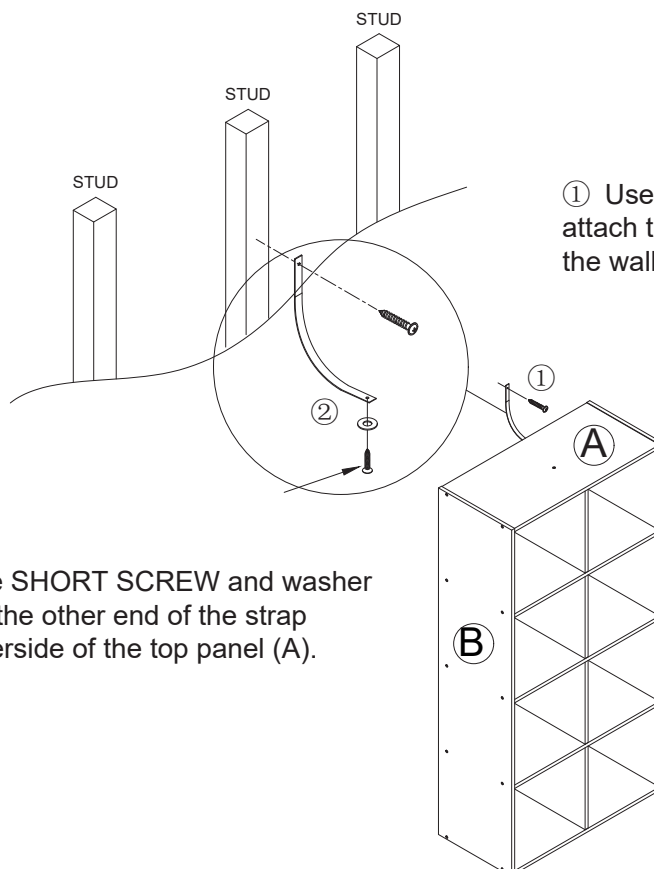

- ① Use the LONG SCREW to attach the strap directly into the wall stud.

- ② Use the SHORT SCREW and washer to secure the other end of the strap to the underside of the top panel (A).

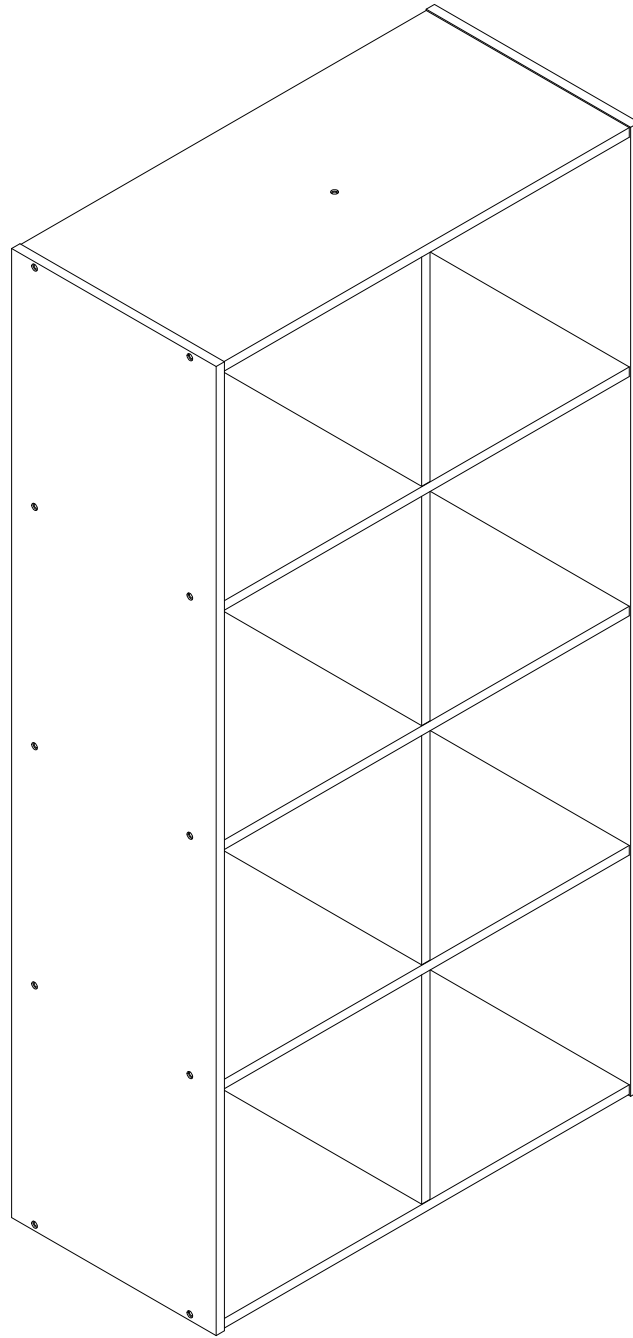

Technical Support

(909)637-7665 | (909)637-7593

Other Info

HJ-Customer-Service@outlook.com

Thank you for choosing this product. We strive to provide you with the best quality products and service in the industry. Should you have any issues, please don't hesitate to contact us.