

ASSEMBLY INSTRUCTIONS

STEP 1

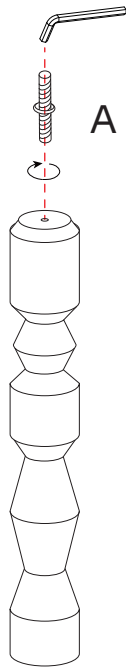

STEP 2

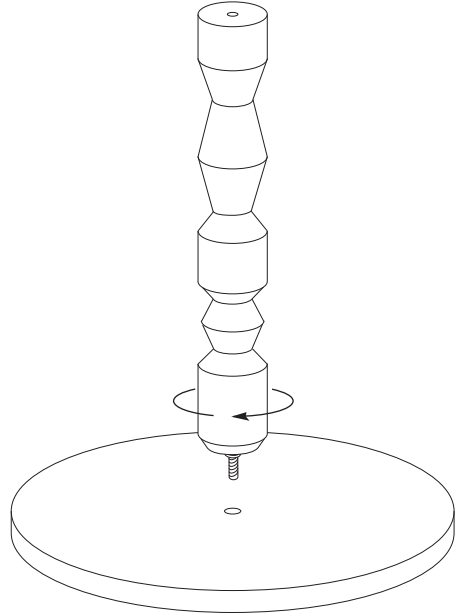

STEP 3

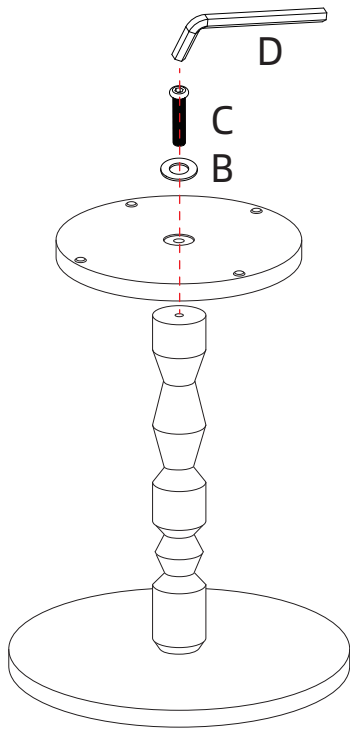

STEP 4

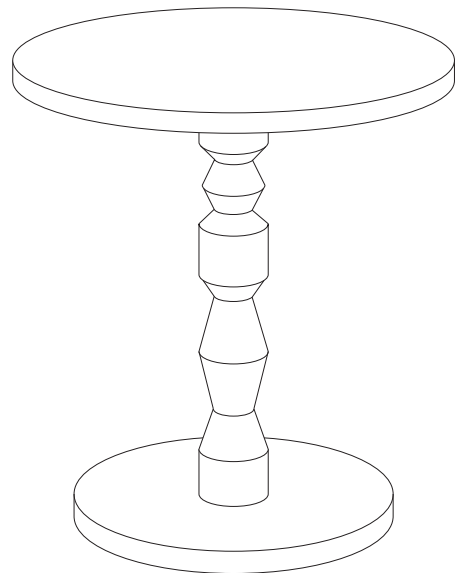

Ax1

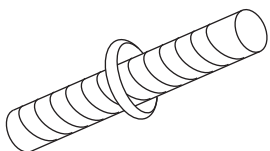

Bx1

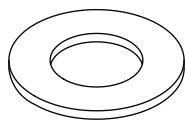

Cx1

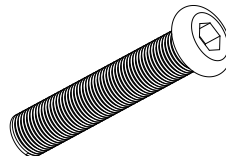

Dx1

