

**ASSEMBLY AND CARE
INSTRUCTION**
Coffee Table Set of 3

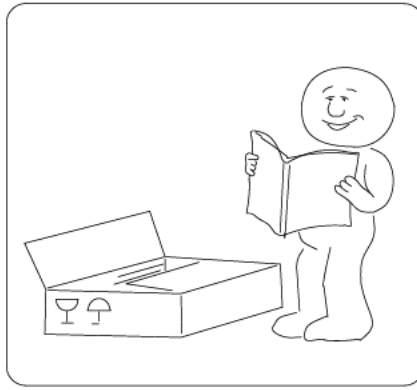

! WARNING !

1. PLEASE READ ALL INSTRUCTIONS CAREFULLY BEFORE STARTING ASSEMBLY.
2. DO NOT LET ANY SHARP OBJECTS TOUCH OR RUB THE SURFACE OF THE PRODUCT.
3. WHEN ASSEMBLING, DO NOT LET CHILDREN PLAY AROUND THE WORKING AREA.
4. PLEASE CONFIRM ALL PARTS ARE CORRECT BEFORE STARTING THE ASSEMBLY PROCESS.
5. DO NOT TIGHTEN ALL BOLTS AND SCREWS COMPLETELY UNTIL THE ENTIRE UNIT HAS BEEN ASSEMBLED AND SET UP.

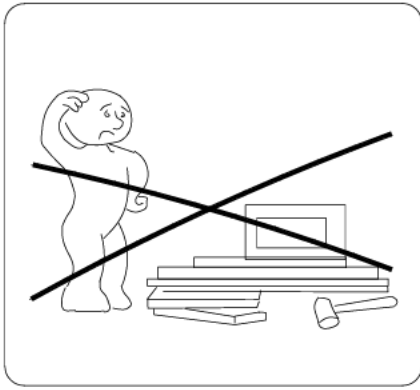
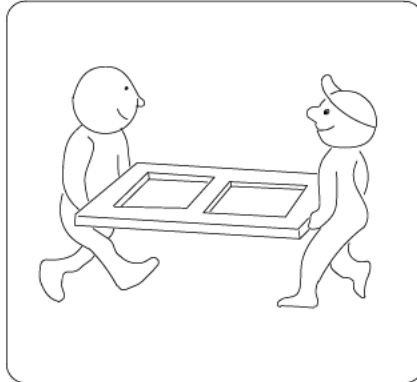
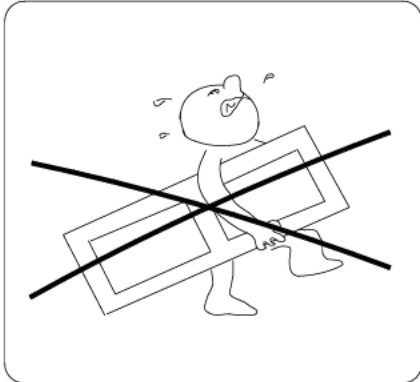
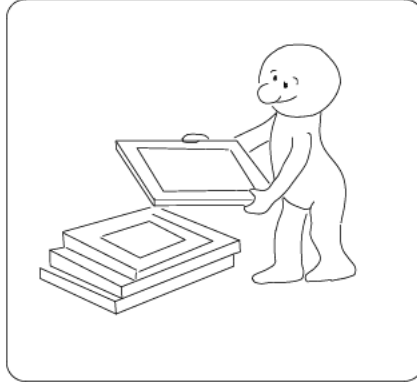
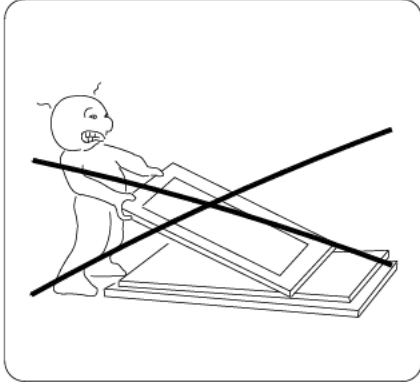

ADVISE

1. DO NOT SIT OR STAND ON THIS PRODUCT. IT IS INTENDED FOR PETS ONLY.
2. THIS PRODUCT SHOULD BE ASSEMBLED BY AN ADULT.
3. PLEASE PUT THE PRODUCT ON A SMOOTH SURFACE AFTER YOU ASSEMBLED IT.
4. PLACE ALL PARTS ON A CLEAN AND SMOOTH SURFACE SUCH AS A RUG OR CARPET TO AVOID THE PARTS FROM BEING SCRATCHED.
5. THE SCREW OF HINGE ON THE DOOR ALSO CAN BE ADJUSTABLE, TO MAKE IT EVEN THEN TIGHTEN ALL SCREWS.

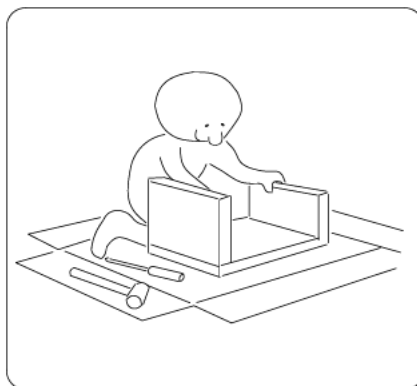
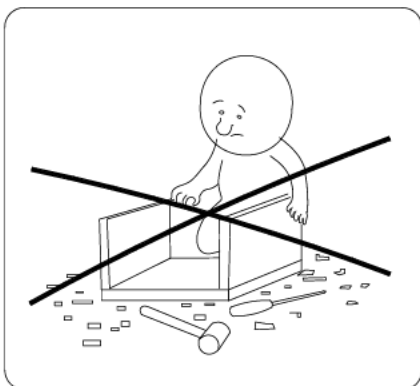
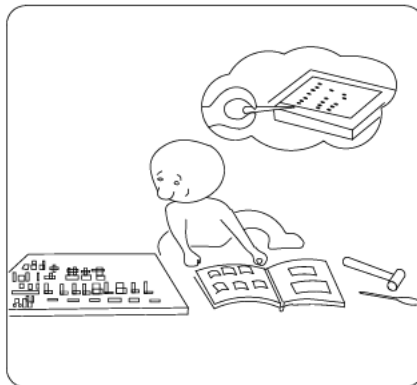
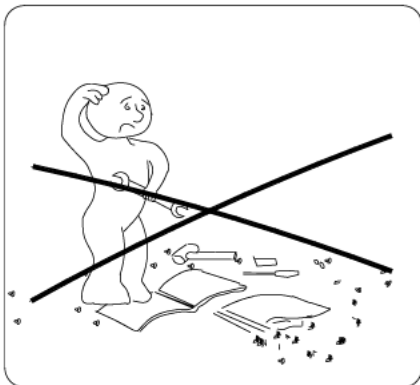

PARTS

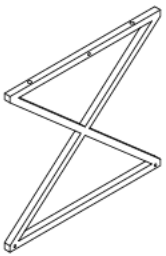
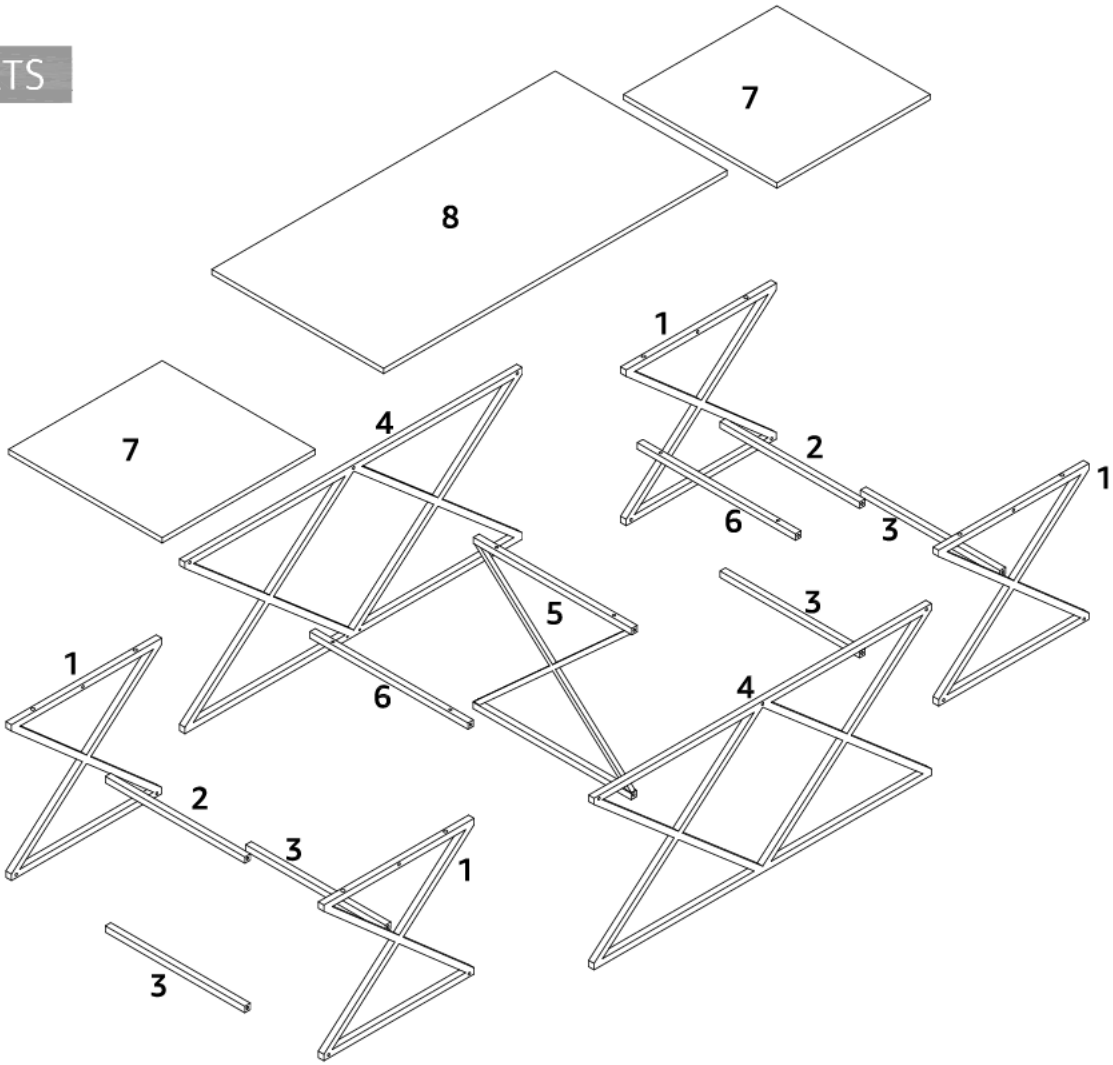

1
Leg Frame
x4



2
Strecher
x2



3
Strecher
x4

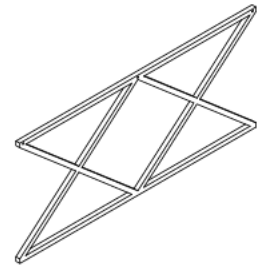

4
Leg Frame
x2

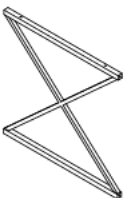

5
Support Tube
x1

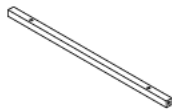

6
Strecher
x2

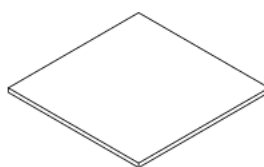

7
Square Table Top
x2

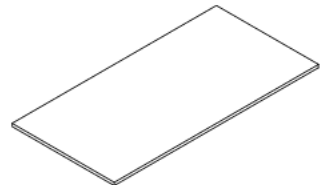

8
Rectangle Table Top
x1

HARDWARE



A
x 34 pcs



B
x 12 pcs



C
x 1 pc

ASSEMBLY INSTRUCTIONS

- 1 Connect stretcher 2 & 3 to leg frame 1 with bolt A by Allen Wrench C.
Install adjustable feet B to stretcher 3.

Please tighten all bolts at last.

A x 12 pcs	B x 8 pcs	C x 1 pc

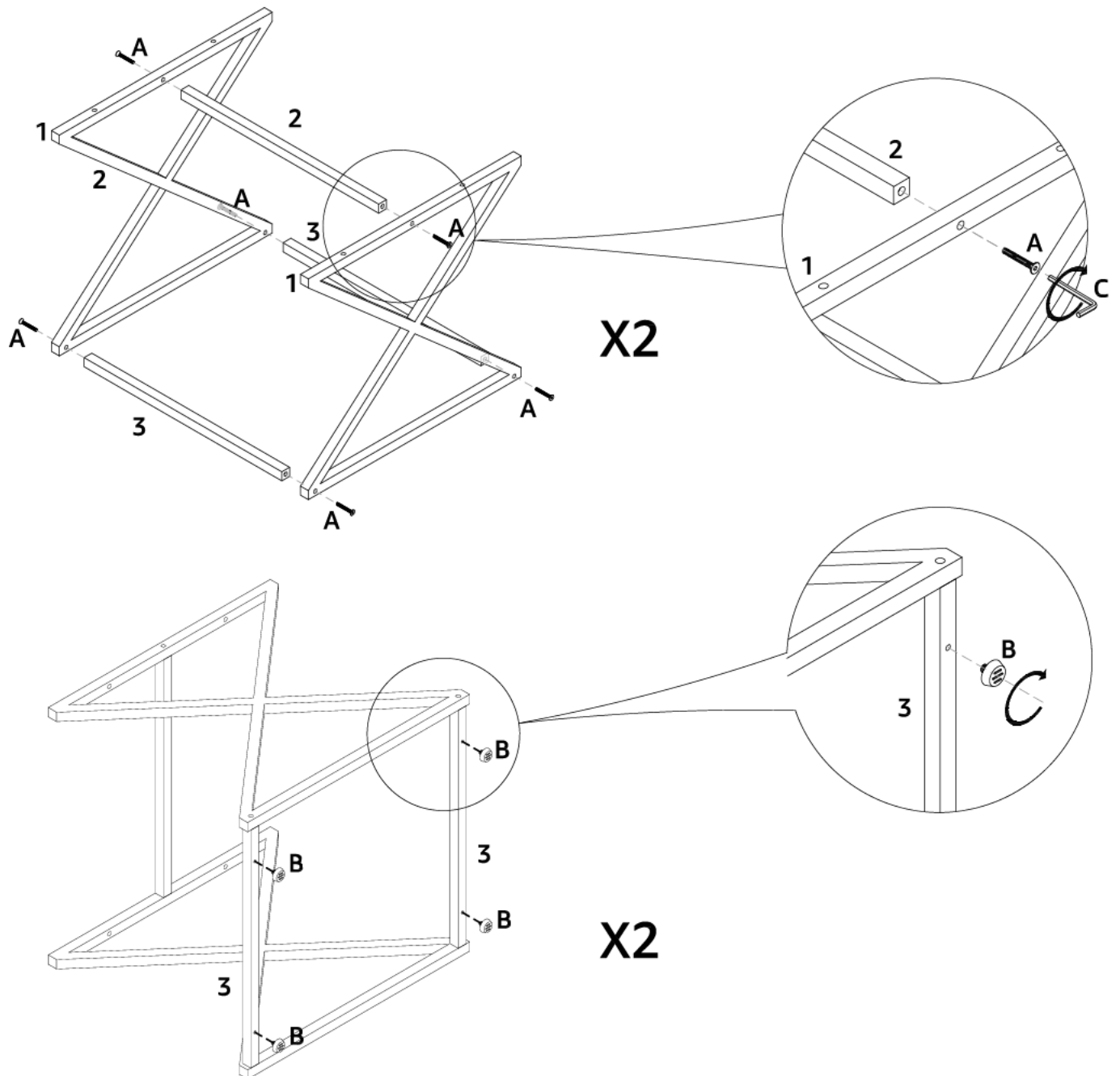

2

Connect square table top 7 to leg frame 1 with bolt A by Allen Wrench C.
Connect stretcher 6 to leg frame 4 with bolt A by Allen Wrench C.
Connect support tube 5 to leg frame 4 with bolt A.

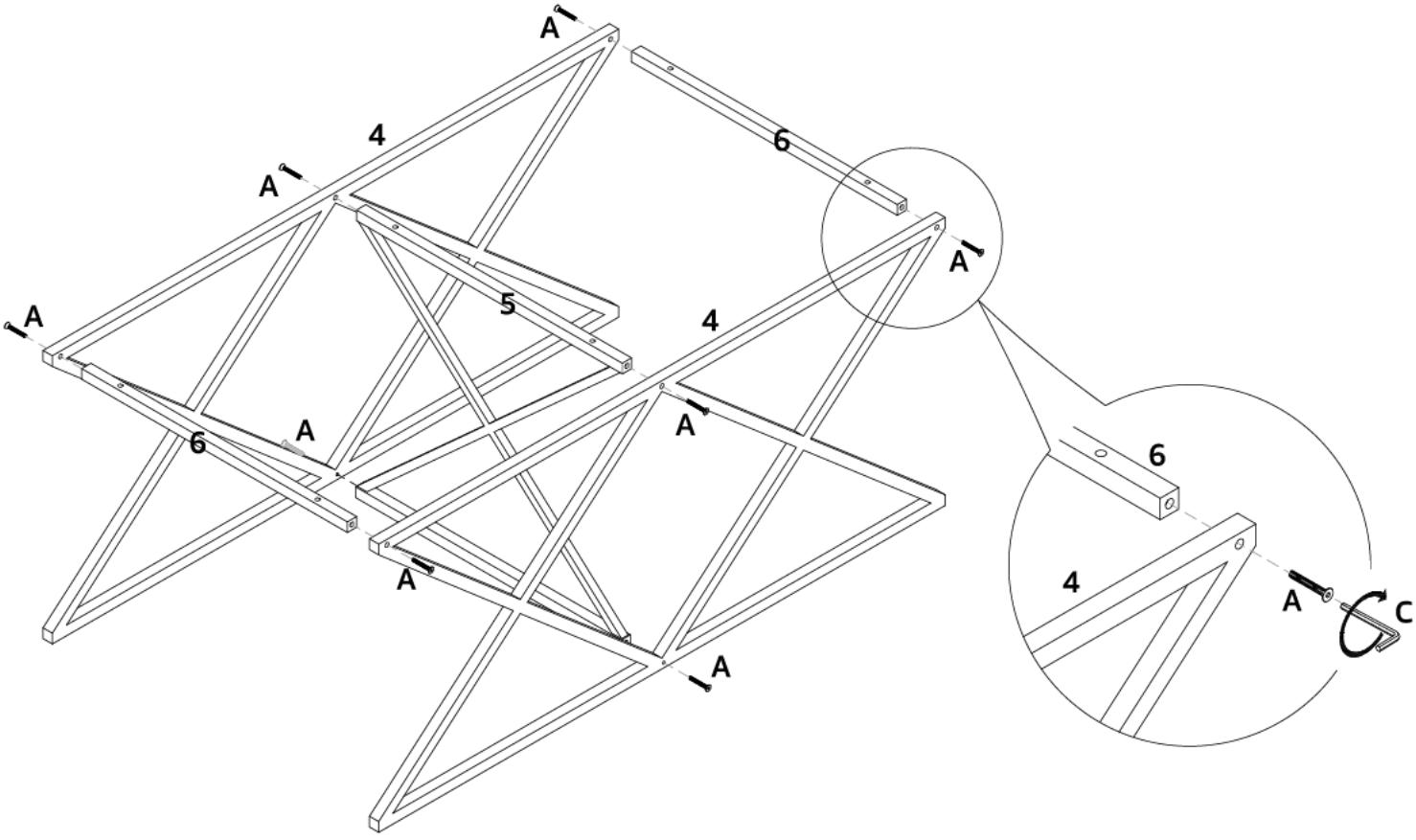
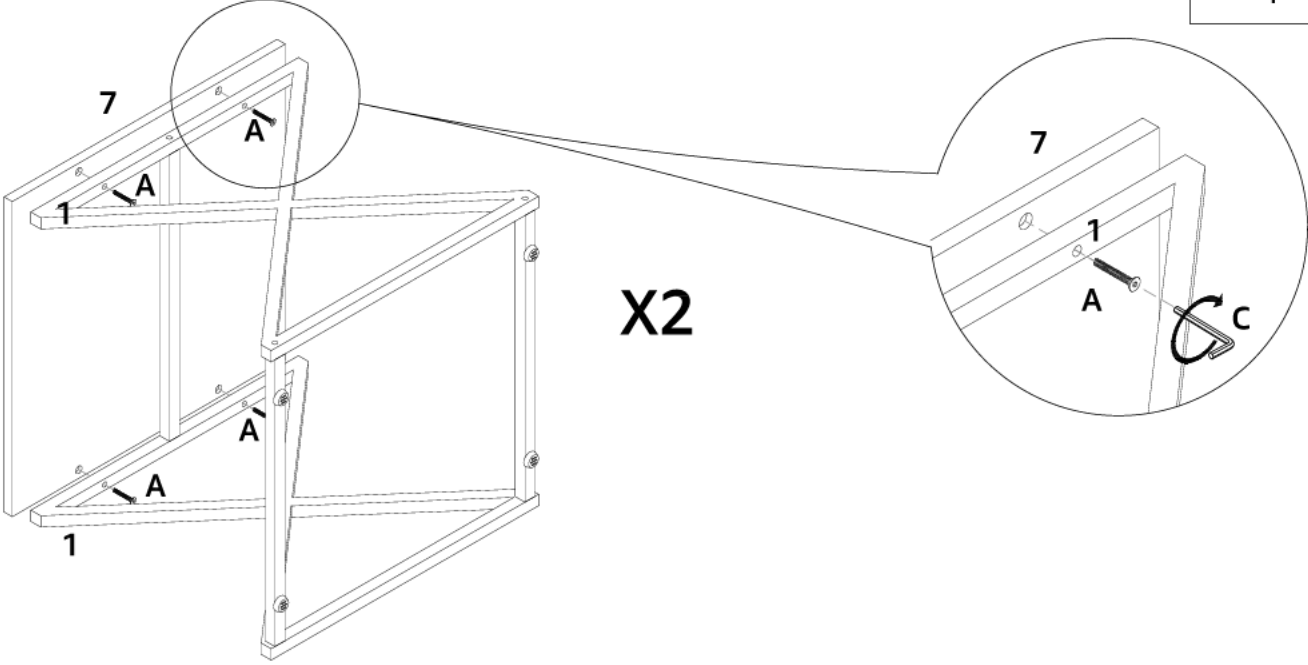
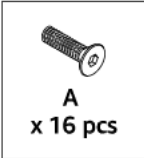

3 Tighten adjustable feet B to leg frame 4.

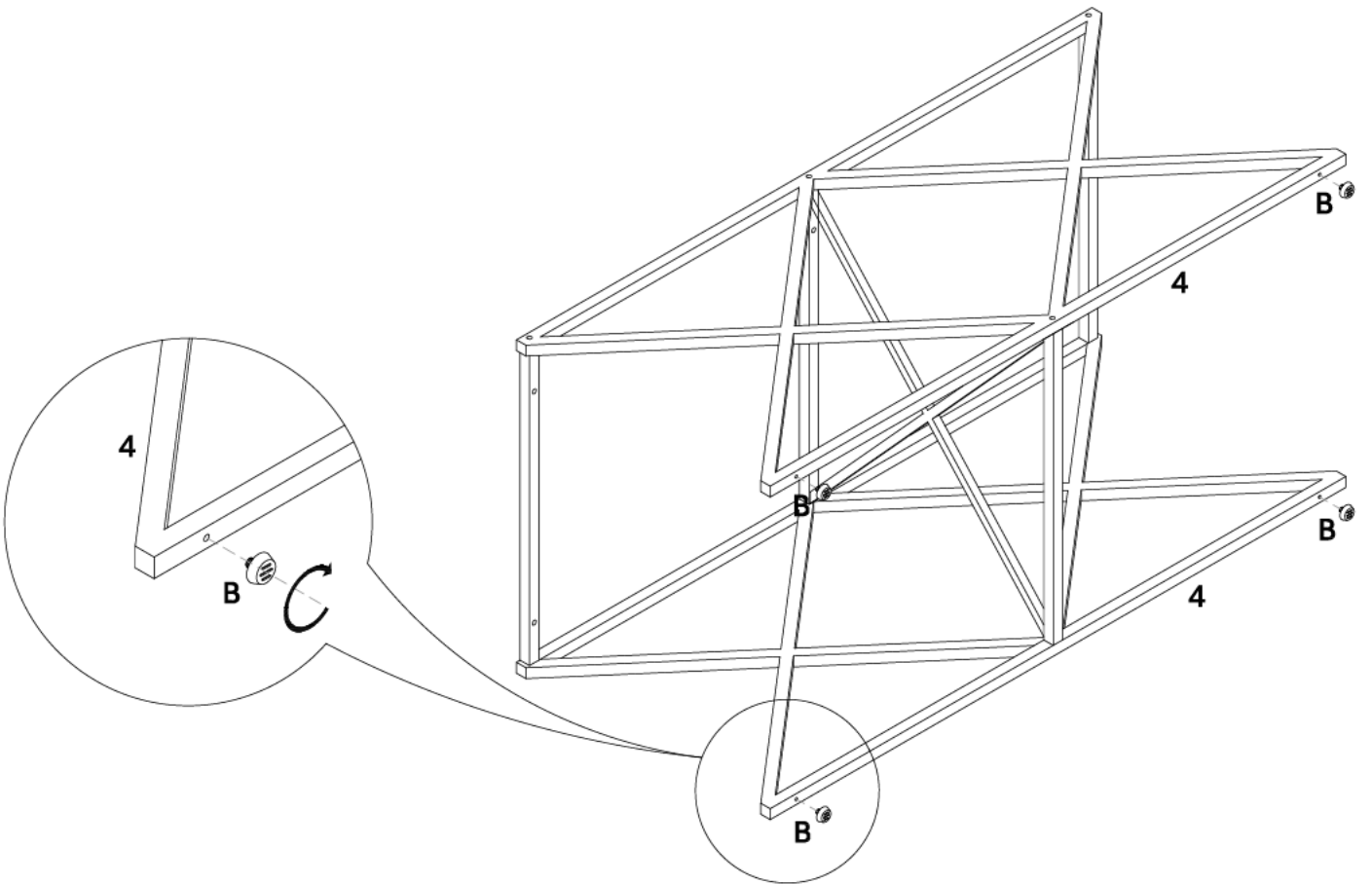
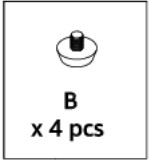

- 4 Connect rectangle table top 8 to strecher 6, support tube 5 with bolt A by Allen Wrench C.
Check and tighten all bolts.

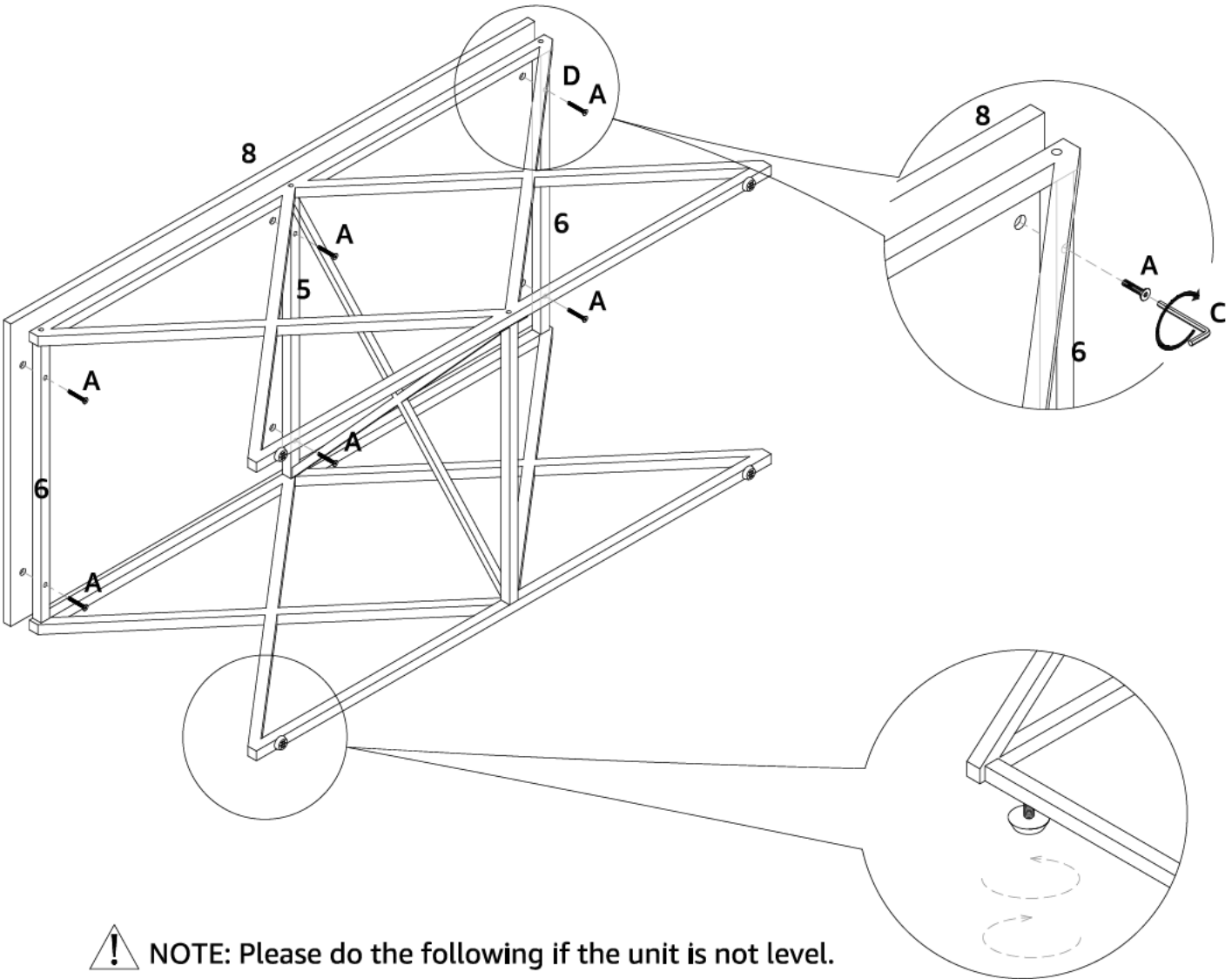
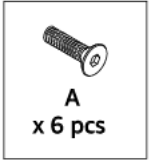

⚠ NOTE: Please do the following if the unit is not level.