

# ASSEMBLY INSTRUCTION

## ITEM NO : 510&520-CKING&EKING





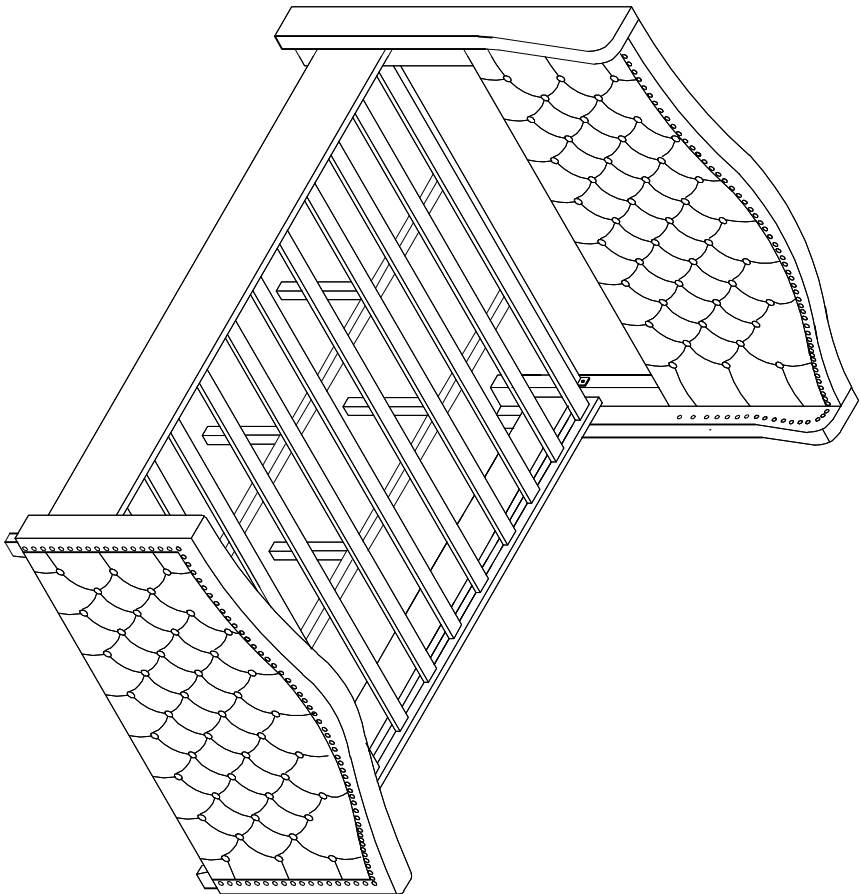

**IMPORTANT: PLACE ALL PARTS ON A CLEAN AND SMOOTH SURFACE SUCH AS A RUG OR CARPET TO AVOID THE PARTS FROM BEING SCRATCHED**



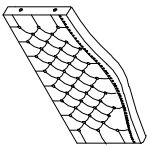
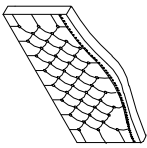
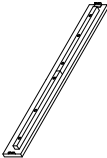

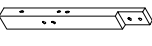

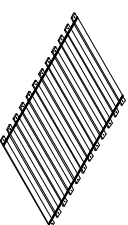
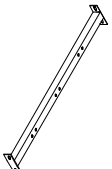
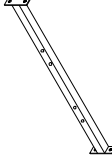



**KINDLY FOLLOW THE ASSEMBLY INSTRUCTIONS STEP**

**DO NOT TIGHTEN ALL SCREWS UNTIL THE BED IS FULLY SET-UP**



### PARTS LIST:

 <p>① Headboard=1pc</p>	 <p>② Footboard=1pc</p>	 <p>③ Side Rail=2pcs</p>	 <p>④ Wingpack=2pcs</p>
 <p>⑤ HB Leg=2pcs</p>	 <p>⑥ FB Feet=2pcs</p>	 <p>⑦ Slats=12pcs</p>	 <p>⑧ Support rail= 2pcs</p>
 <p>⑨ Crossband=1pc</p>	 <p>⑩ Support Leg=6pcs</p>	<p><b>HARDWARE LIST:</b></p>	

 <p>Ⓐ Allen Key=1pc</p>	 <p>Ⓑ Bolt <math>\frac{3}{8}</math>"x<math>1\frac{1}{2}</math>"=16pcs</p>	 <p>Ⓒ Bolt <math>\frac{1}{8}</math>"x2"-26pcs</p>	 <p>Ⓓ Bolt <math>\frac{5}{16}</math>"x<math>4</math>"=2pcs</p>
 <p>Ⓔ Flat Washer <math>\frac{1}{8}</math>"x19=62pcs</p>	 <p>Ⓕ Flat Washer <math>\frac{5}{16}</math>"x22=10pcs</p>	 <p>Ⓖ Spring Washer=32pcs</p>	 <p>Ⓗ screw 10mmx<math>1\frac{1}{4}</math>"=24pcs</p>
 <p>Ⓘ Nut= 16 pcs</p>	 <p>Ⓙ Wrench=1pc</p>		

STEP 1

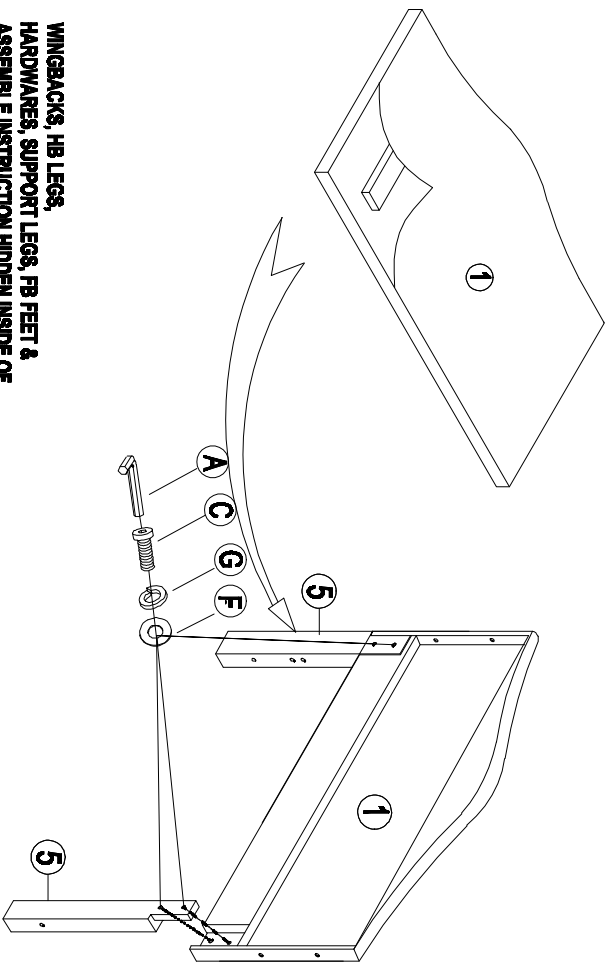

WINGBACKS, HB LEGS,  
HARDWARES, SUPPORT LEGS, FB FEET &  
ASSEMBLE INSTRUCTION HIDDEN INSIDE OF  
THE HEADBOARD. PLZ LIFT THE COVER .

STEP 2

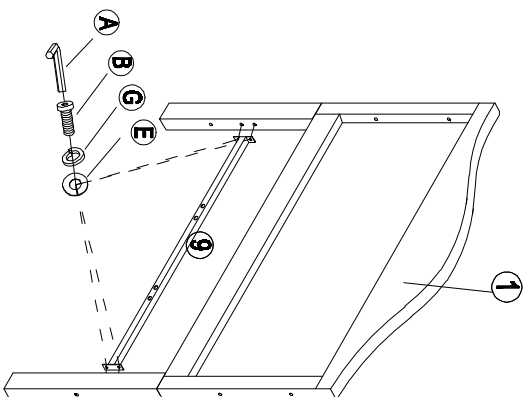

STEP 3

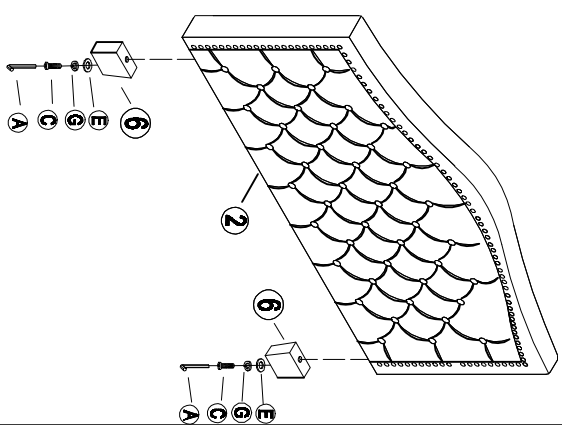

STEP 4

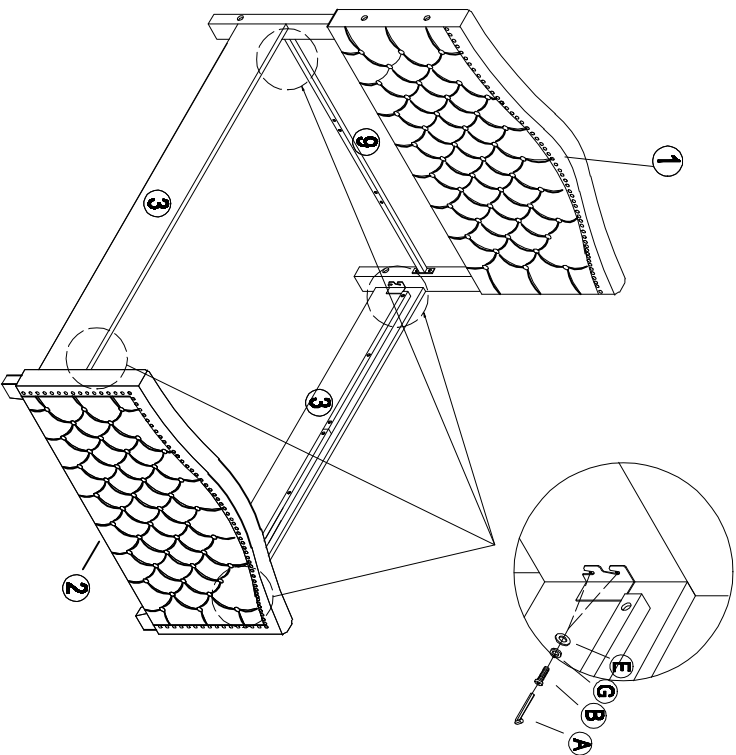

STEP 5

