

- 2** Attach Back Legs (C), Center Support Legs (B), Left Front Leg (D) and Right Front Leg (E) to Sofa Body (A) using Washer (1) and Bolt (2). Tighten using provided Allen Key (4).

Model: _____
Lot No: _____
Date of Purchase: _____

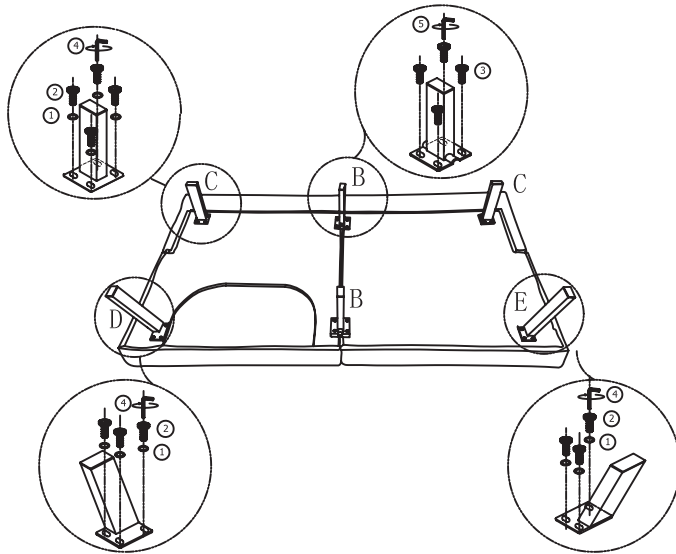

- 3** Operate your convertible sofa by pushing the backrest forward, this will release the sofa to the bed position. Lift the backrest up to transition from bed position to either lounge or sofa position. This sofa has a split back which will allow you to operate either the left or right side independently.

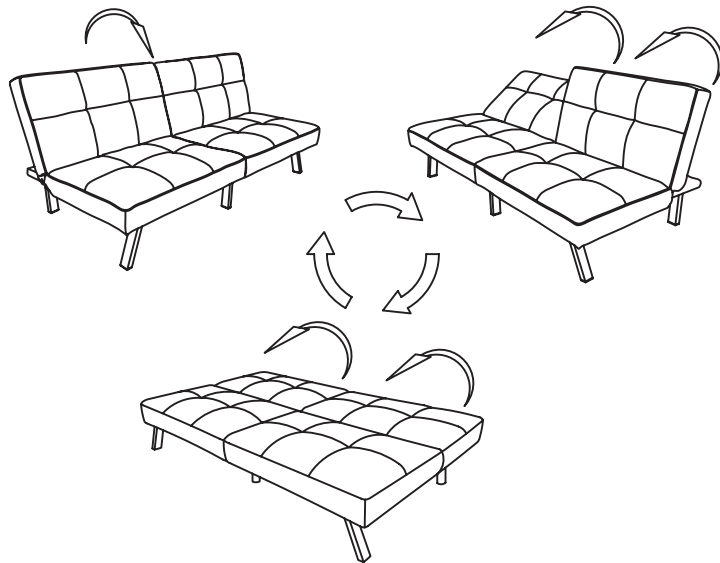

CONVERTIBLE SOFA

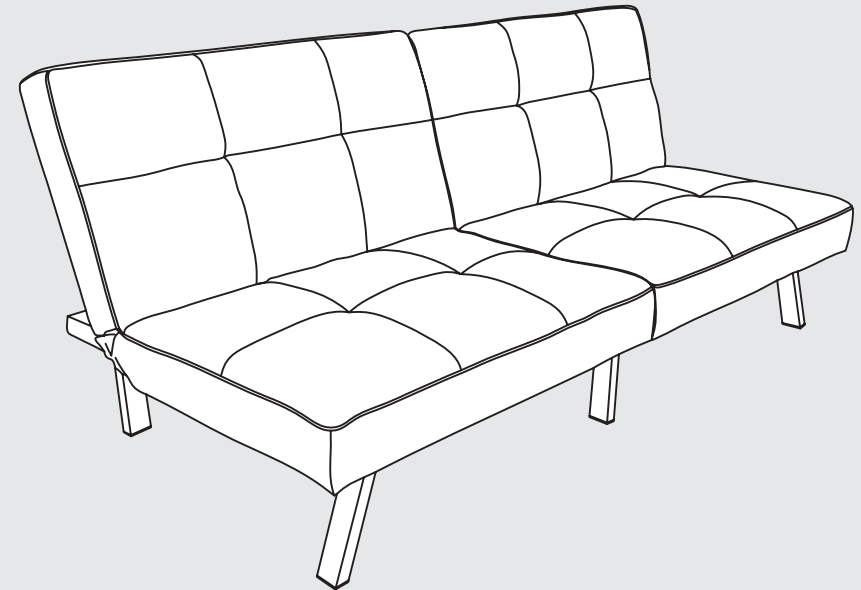

ADULT ASSEMBLY REQUIRED

If you are missing any parts or have any questions regarding assembly, do not return this item to the retailers store. Please call our toll-free, customer service number and have this assembly manual open to the parts list ready to provide the model name, number and part name or number.



WARNING: This product may contain small components, please ensure they are kept away from small children.

HARDWARE

Please do not completely tighten any screws until the entire assembly is complete. Once assembly is complete, please be sure to tighten all hardware.

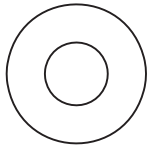

1. Washer
14x

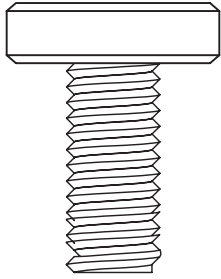

2. Bolt 5/16" x 1"
14x

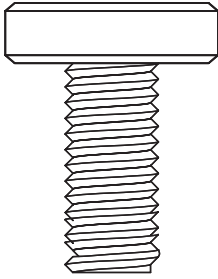

3. Bolt 1/4" x 1/4"
8x

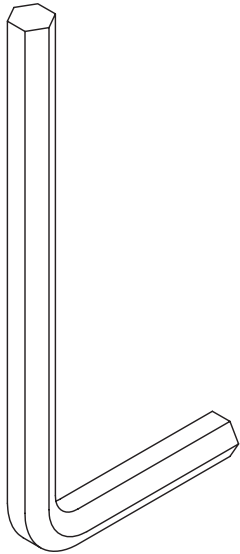

4. 5 mm Allen Key
1x

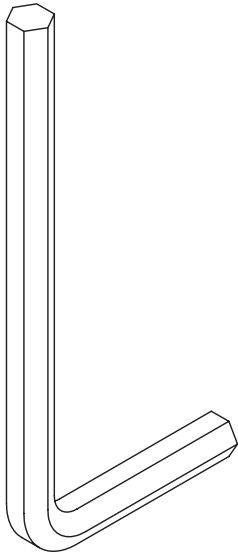

5. 4 mm Allen Key
1x

PARTS

Avoid using sharp objects such as a knife to cut open packing as you may accidentally damage the upholstery.

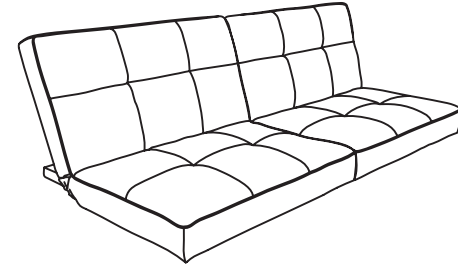

A. Sofa Body
1x

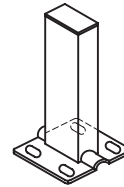

B. Center
Support Leg
2x

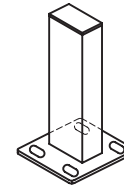

C. Back Leg
2x

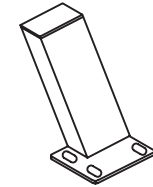

D. Left Front Leg
1x

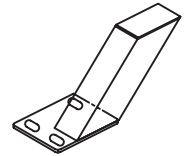

E. Right Front Leg
1x

ASSEMBLY INSTRUCTIONS

Do not fully tighten bolts until assembly is complete.

- 1 Flip Sofa Body (A) over.
Pull out Hardware and Parts from the zippered compartment.

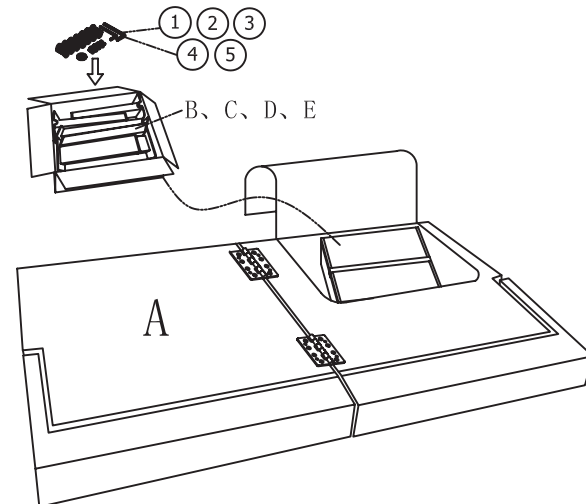

FINGER GUARD

- U.S. Patent No. 8,875,321
- Provides Users a Permanent Safety Solution
- Eliminates the Risk & Liability of an Accident
- Heavy Duty, Fully Welded, Protective Metal Plate