

# INSTRUCTION MANUAL

## Aluminum Textilene Dining Chair

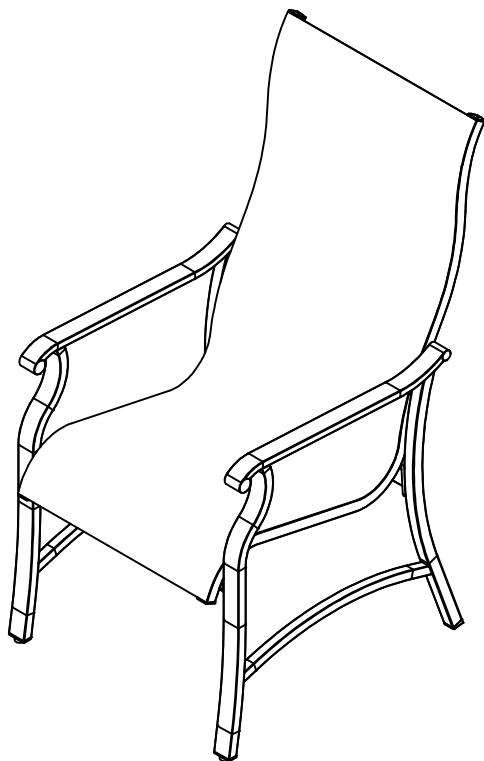

# INTRODUCTION

Patio Time is appreciating your trust and purchase for supporting your home decorating plans. This item is designed ergonomically and manufactured by Patio Time.

Patio Time is always devoted to R&D innovation and each year launches diverse outdoor collections with high quality.

After unpacking, please check if the parts show any damage. In addition, please check if all parts and hardware are in position before assembly. If there is any damage or missing, please do not assemble firstly and call customer service. If you do not have the parts lists, you can require your dealer to send you immediately.

This furniture can be applied for both indoor and outdoor environment. Please take time to read and follow the instructions below. Use the item as described in this operating manual. Patio Time will not be liable for any damage caused by improper use.

May you enjoy your patio time!

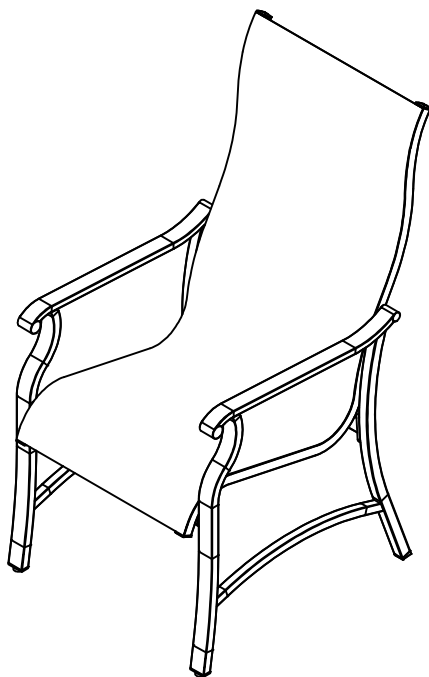

Step1: Attach back horizontal pipe (B) to left armrest (D) using 2 bolts (E) , 2 spring washers (H), 2 washers (G). Do not screw down.  
Attach seat and back (A) to left armrest (D) using 1 bolt (E) , 1 bolt (F), 1 spring washer (H), 1 washer (G). Do not screw down.





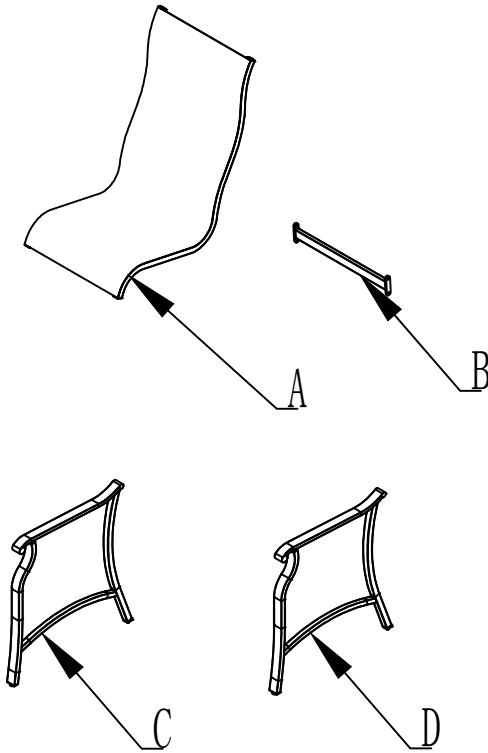
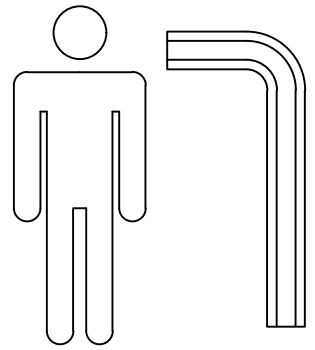
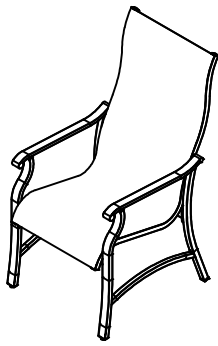

Step 2 : Attach back horizontal pipe (B) to right armrest (C) using 2 bolts (E) , 2 spring washers (H), 2 washers (G). Do not screw down.  
Attach seat and back (A) to right armrest (C) using 1 bolt (E) , 1 bolt (F), 1 spring washer (H), 1 washer (G). Do not screw down.

Step3: Upon completion of full assembly and bolted up-all screws can be tightened down.

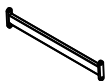
Note:Please do not tighten any bolt until all bolts have been put into right place.

If you tighten one bolt, it maybe cause other bolts out of position.



Part Number	Images and Sizes	Qty.
A		1
B		1
C		1
D		1
E	 M6*20	6
F	 M6*40	4
G	 M6*ø16	10
H	 M6*ø9.5	10

# 1

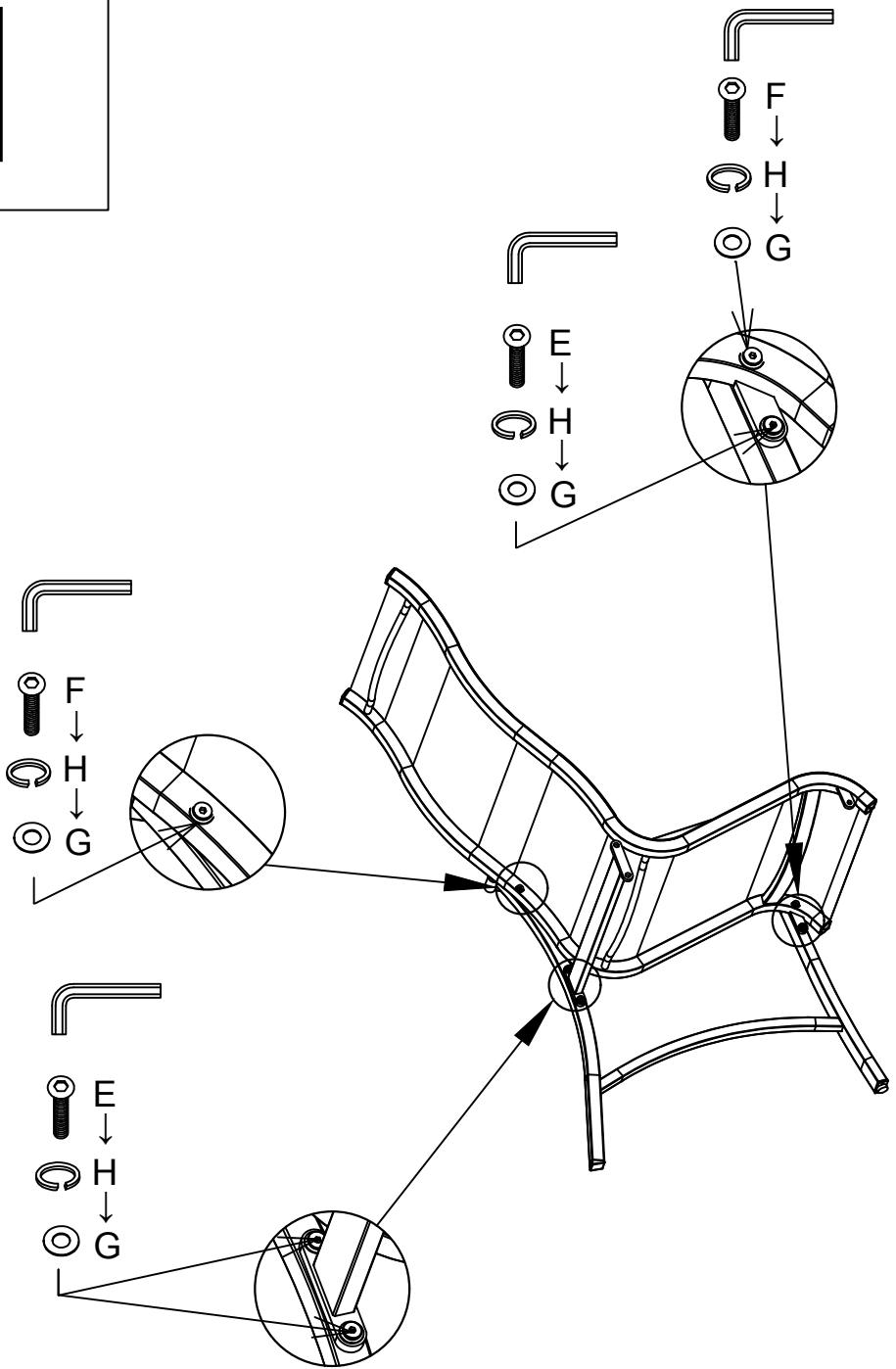

# 2

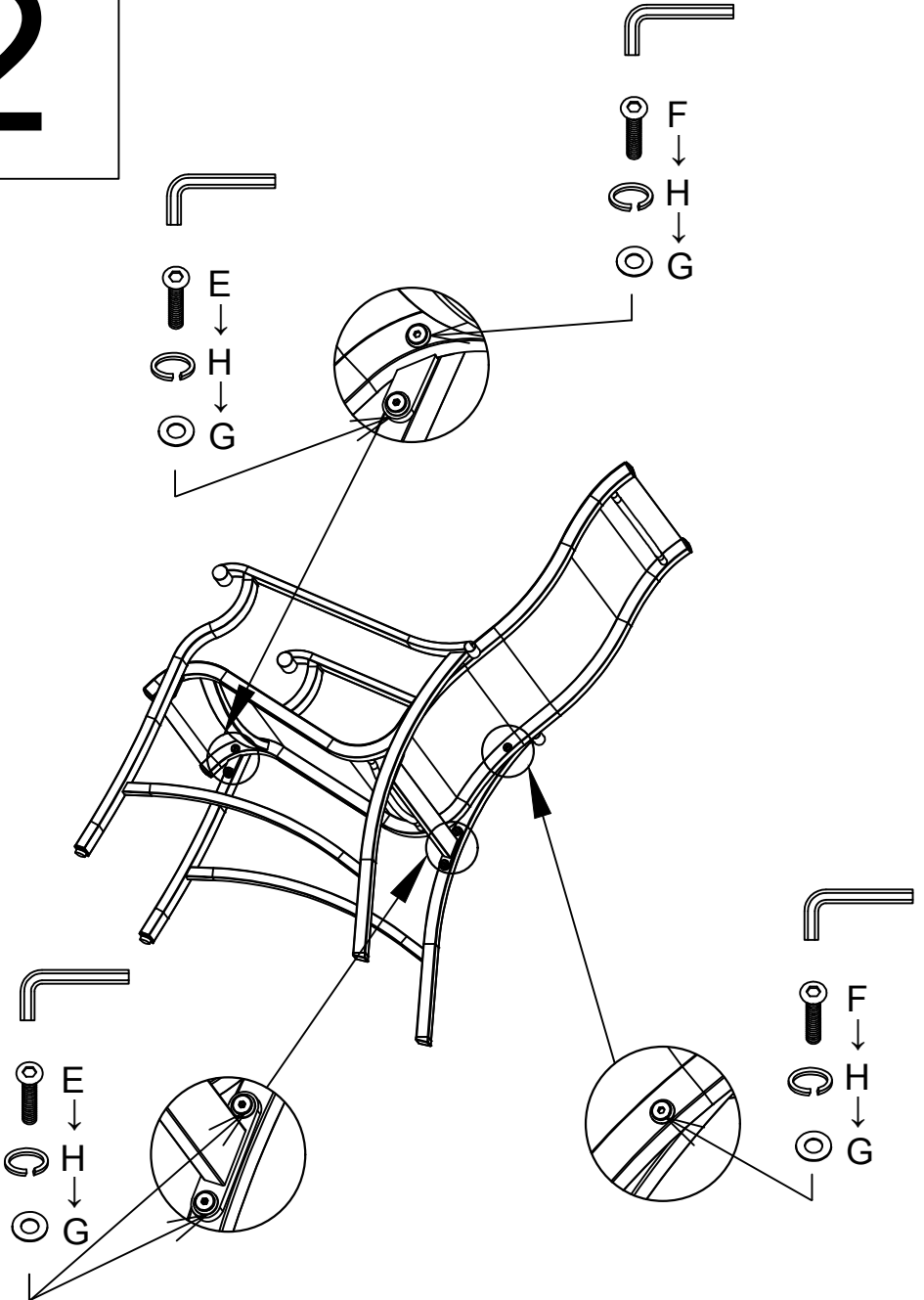

## CARE AND MAINTENANCE

Following the instructions to make the item remain in its best status as long as possible. The solutions below are only regarded as a general guideline. For more information, please contact us.

Rinse it thoroughly with clean water to wash away dirt and grime. Never use abrasive cleanser on the furniture, since it can damage the surfaces and leave scratch marks.

For the stubborn grime and stains, use a soft sponge and mild soapy water, and then dry it with a cloth or paper towel.

Check the stability of screws, nuts and nut caps in priority. Tighten up them after one(1) to two(2) months' use whenever required.

Avoid improper use and be careful not to scratch or damage the surface with sharp objects.

When moving furniture, make sure lifting it rather than pulling or pushing it so as to avoid any damage to the floor, legs and mounting.