







ASSEMBLY INSTRUCTIONS & PARTS IDENTIFICATION CHAIRSIDE TABLE

Thank you for purchasing this quality product. Be sure to check all packing material carefully for small parts that may have come loose inside the carton during shipment.

Parts key			Hardware kit			
No	Qty	Description	No	Description		Qty
1	4 pcs	Legs	A		Bolt - Large to attach the shelf	Ø6 x 50 08 pcs
2	1 pc	Top Frame	B		Bolt - Small to attach the legs	Ø6 x 15 08 pcs
3	1 pc	Glass Insert	C		Lock washer	Ø8 16 pcs
4	2 pcs	Shelf	D		Flat washer	Ø8 x 18 16 pcs
5	4 pcs	Floor Glide	E		Allen key	K4 01 pc
			F		L Plate	04 pcs
			G		Wood Screw	Ø4 x 25 08 pcs

Do not use power tools to assemble this table

Step 1 Attach the L Plate "F" to the top of the legs, by using wood screws "G".

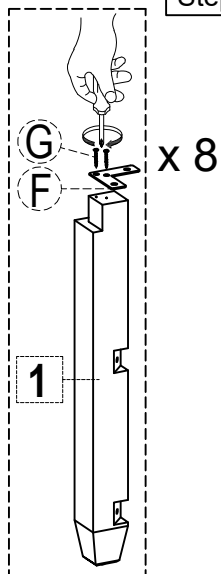

Step 2 Attach the legs to the shelves, then position the legs inside the top frame and attach as shown.

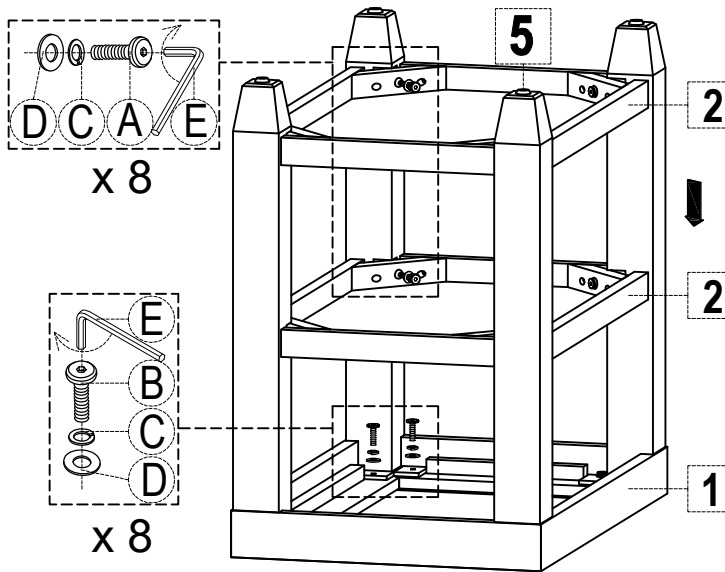

FINISH

Carefully lay the Glass Insert in place

