

# Assembly Instructions

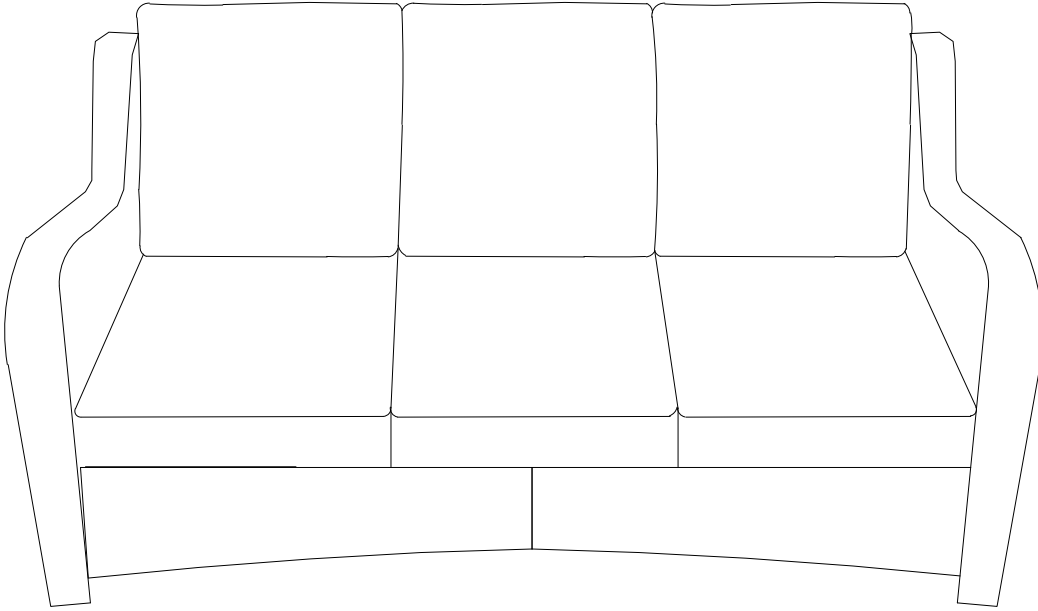









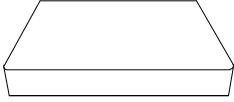
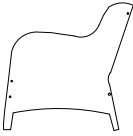

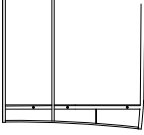
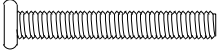
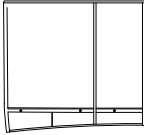
For any missing hardware, damaged parts and other problems.

**\*Don't fully tighten all the bolts till the very end!**

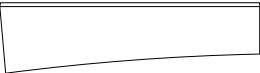
## PRE-ASSEMBLY PREPARATION:

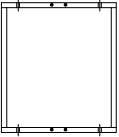
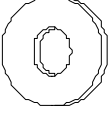
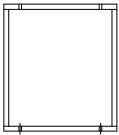
- Please read through the instructions before beginning assembly.
- Clear out the space for assembly and lay out all of the parts based on the Parts List, extra room will allow you to easily determine if all the pieces are present.
- Keep small parts and pieces away from children until fully assembled.

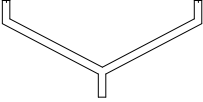
Part no.	Part	QTY	Image	Part no.	Part	QTY	Image
A1	Left arm	1		G	Seat cushion	3	
A2	Right arm	1		H	Back cushion	3	
B1	Left back panel	1		I	Bolt (M6*45mm)	12	
B2	Right back panel	1		J	Bolt (M6*40mm)	4	
C1	Left front panel	1		K	Bolt (M6*35mm)	9	
C2	Right front panel	1		L	Bolt (M6*15mm)	4	
D	Seat middle panel	1		M	Washer M6	29	
E	Seat panel	2		N	Allen wrench	1	
F	Middle foot	1					

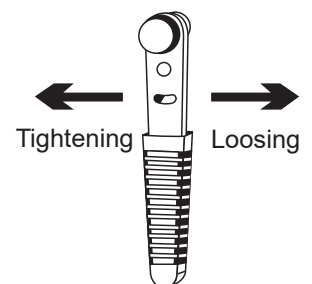
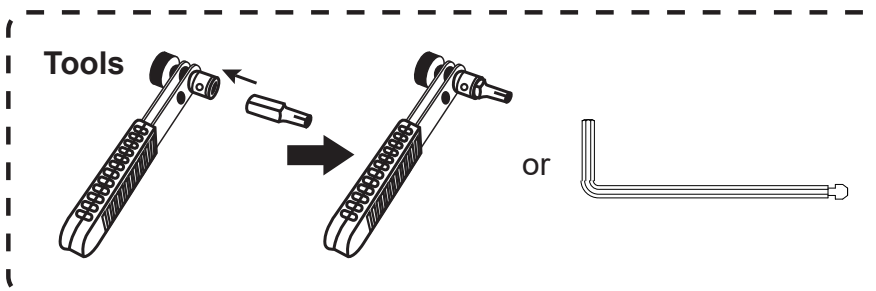

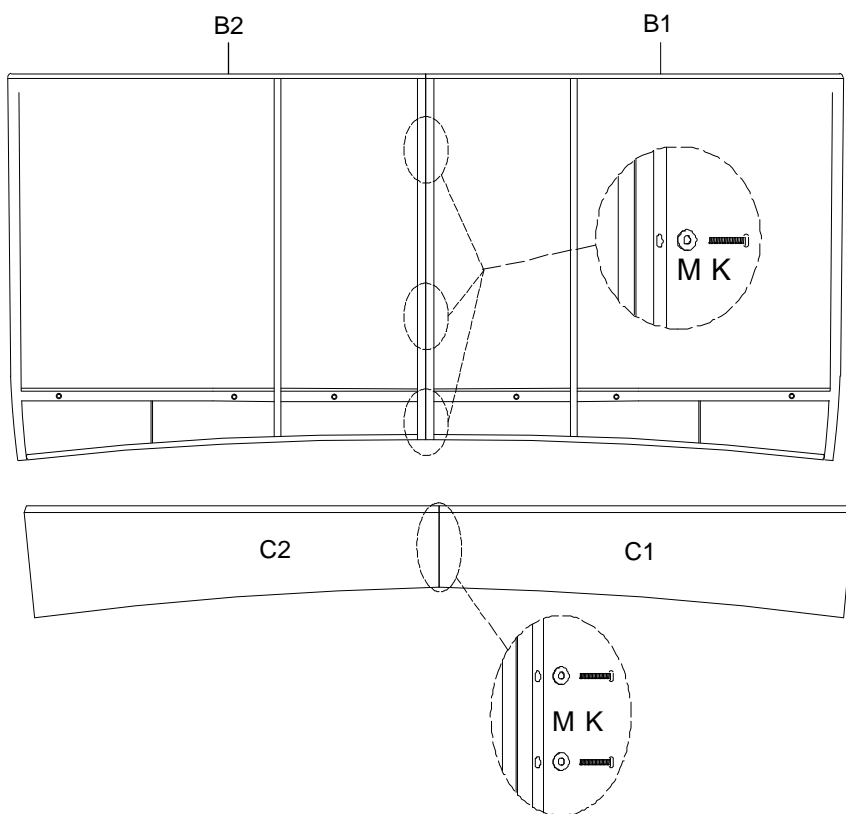

**Step 1:** Attach front panels C1&C2 with 2pcs bolts K and 2pcs washers M, attach back B1&B2 with 3pcs bolts K and 3pcs washers M, using Allen wrench N. Note: Don't fully tighten the bolts.

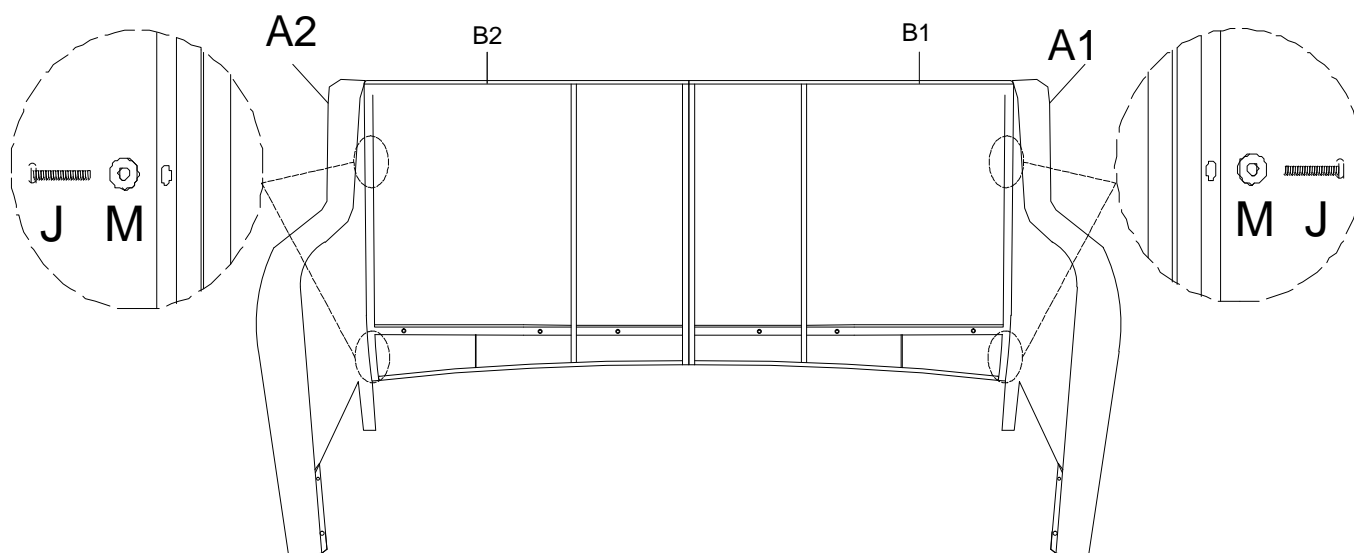

**Step 2:** Attach arms A1&A2 to back panels B1&B2 with 4pcs bolts J and 4pcs washers M, using Allen wrench N. Note: Don't fully tighten the bolts.



J		M6*40	4
M		Ø16*Ø6.5*1	4

**Step 3:** Attach arms A1&A2 to front panels C1&C2 with 4pcs bolts K and 4pcs washers M, using Allen wrench N. Note: Don't fully tighten the bolts.

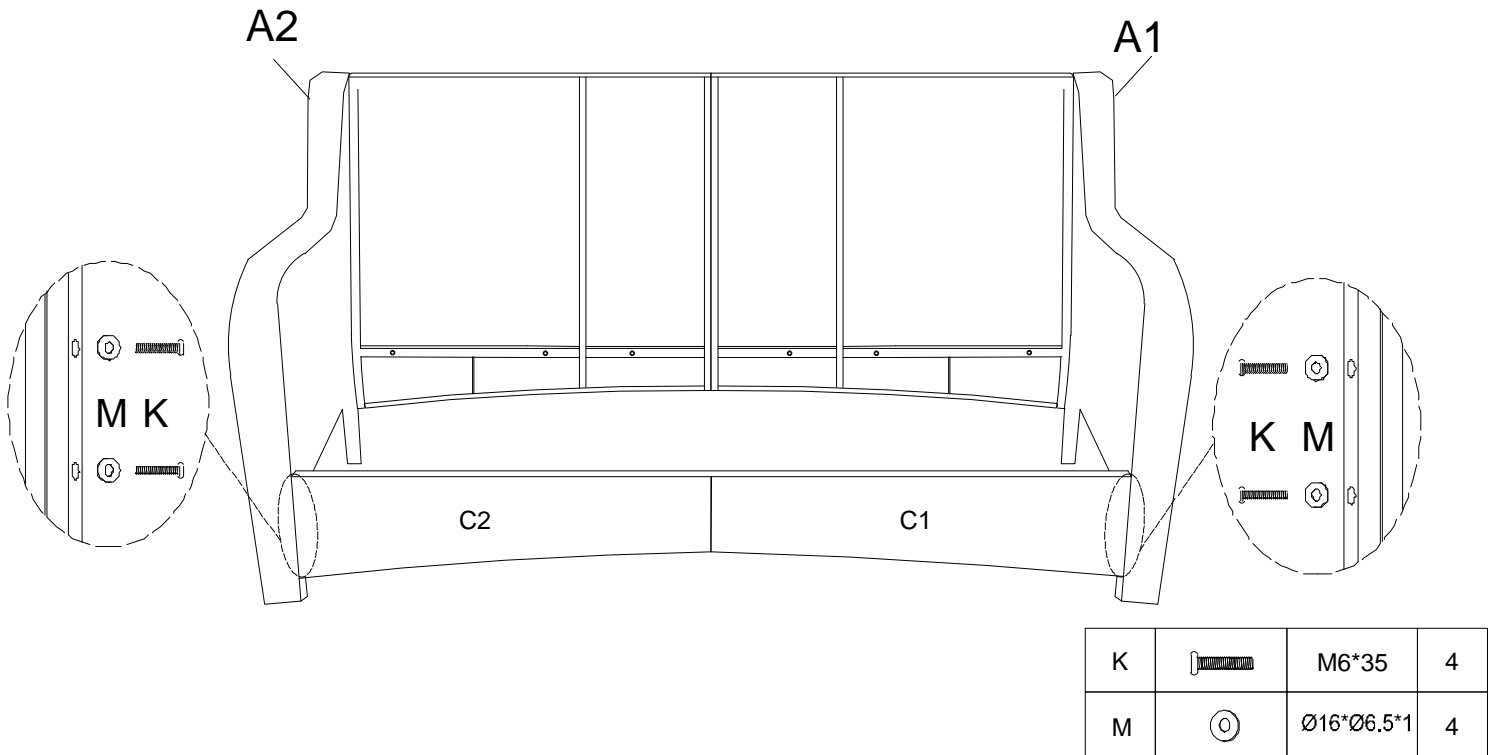

**Step 4:** Attach seat panels D&E to front panels and back panels with 12pcs bolts I and 12pcs washers M, using Allen wrench N. Note: Don't fully tighten the bolts.

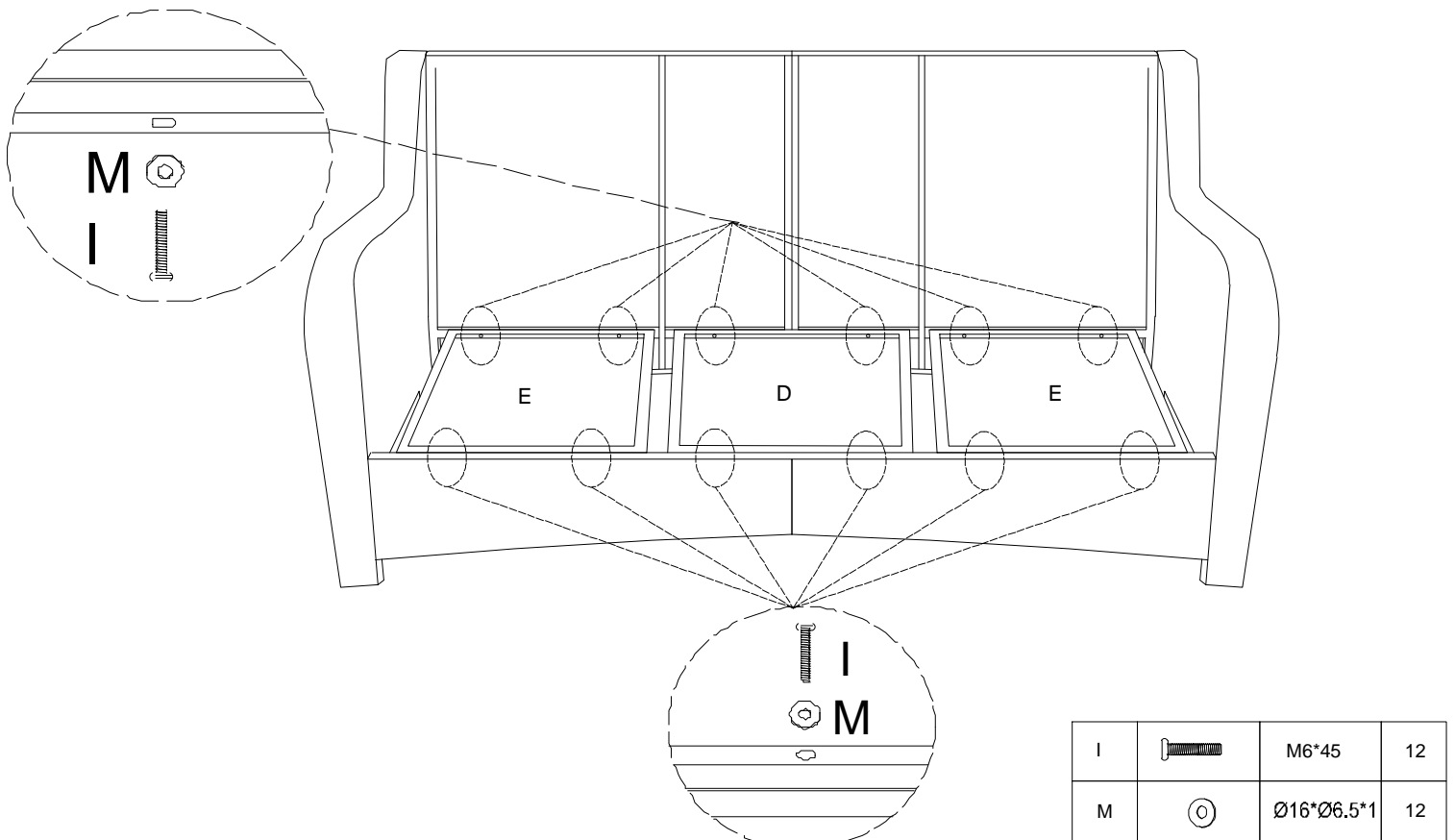

**Step 5:** Attach middle foot F to seat middle panel D with 4pcs bolts L and 4pcs washers M, using Allen wrench N. Note: Please fully tighten all the bolts.

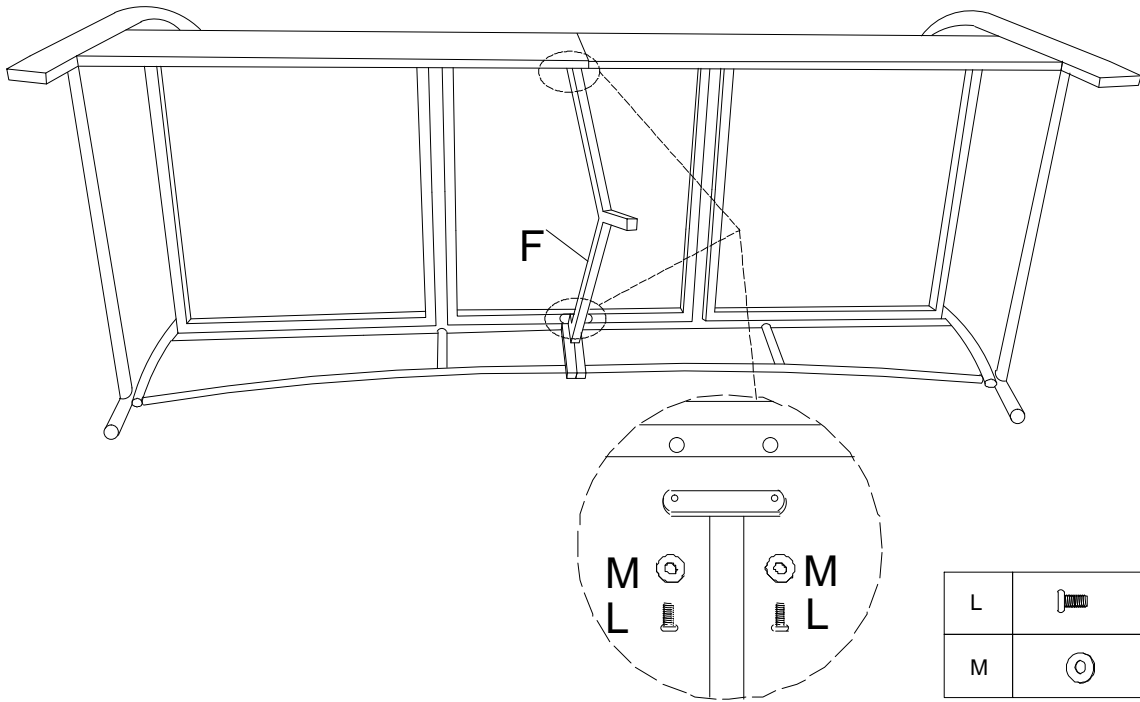

**Step 6:** Put seat cushions G and back cushion H onto the seat .  
Assembly is now complete and the product is ready for use.

