

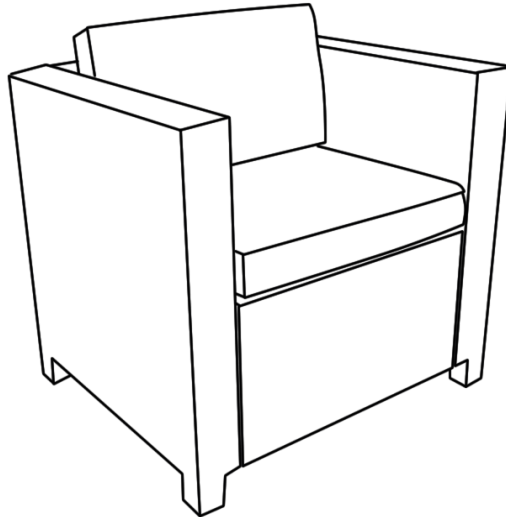

# Assembly Instructions

**Caution : You must read this before you proceed**

## Chair



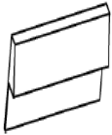
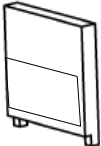
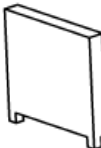
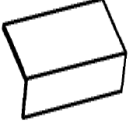



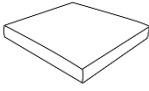

## Parts List

Label	Picture	Description	QTY
A		Chair - Backrest	1
B		Right Armrest	1
C		Left Armrest	1
D		Seat	1
E1		Back Cushion	1

F1		Seat Cushion	1
----	---	--------------	---





## Hardware

Label	Picture	Description	QTY
①		Plastic Cap	13
②		Bolt M6*45mm	9
③		Washer	13
④		Spring Washer Ø16*2mm	13
⑤		Allen Key	1
⑥		Bolt M6*40mm	5

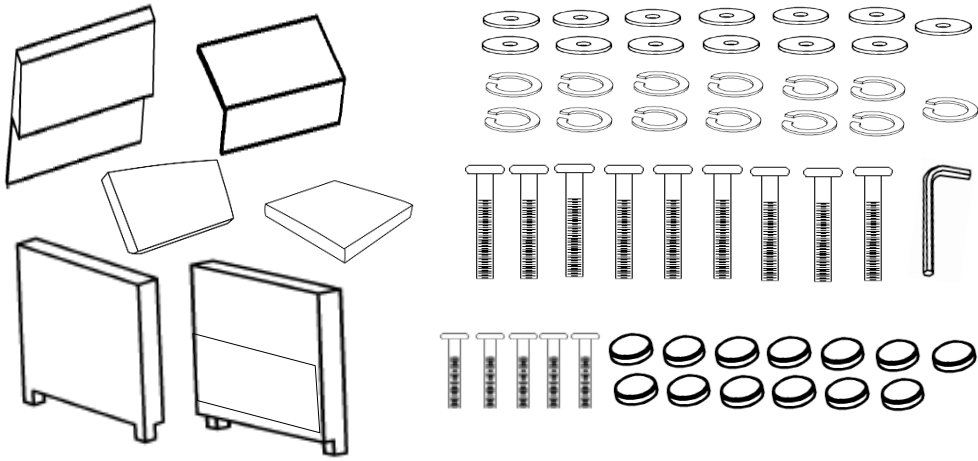
## Assembly Preparation

**Before Beginning Assembly:**



-  • Read instructions, cover to cover-
-  • Have 2 adults on hand for assembly-
-  • Do not assemble on flooring or carpet-
-  • Assemble on a clean non-marring surface (packing foam)-
-  • Save all packaging until finished-

# Assembly Steps

## Overview

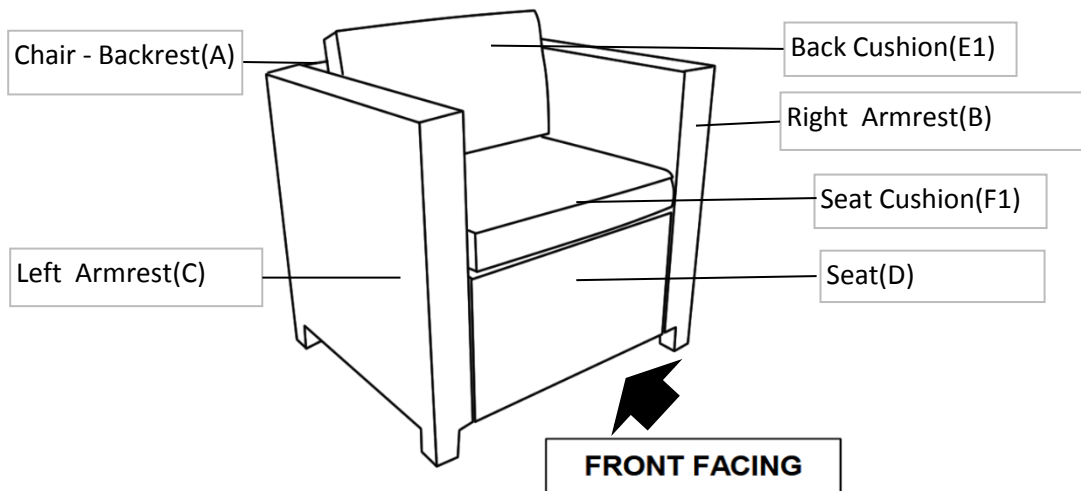

This Chair has multiple parts and may require up to some 30 minutes to assemble. To give you an overview of the Chair parts, the above picture is to help you put the various parts into perspective. Please read through the instructions herebelow to familiarise yourself with the parts and steps before assembly.

## Step 1

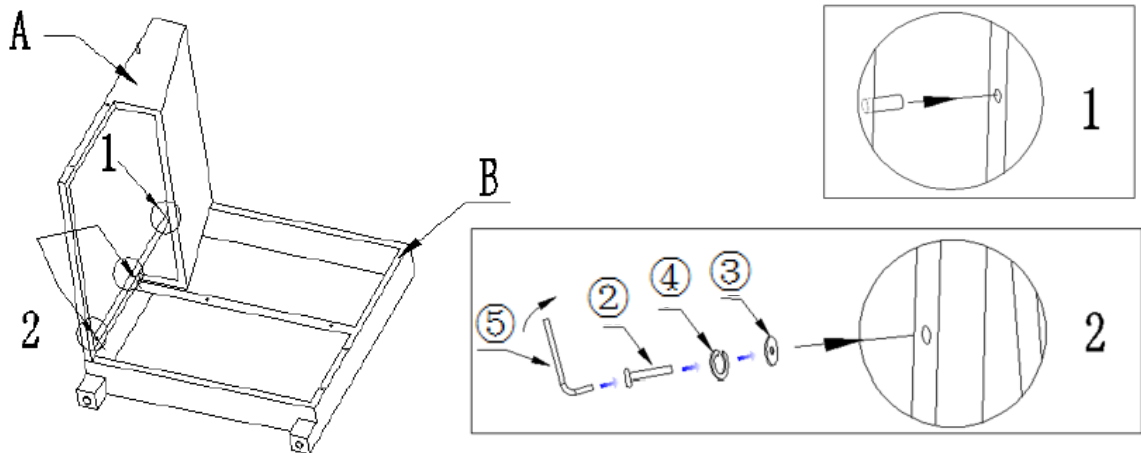

Open the carton and place all the parts onto a clean and soft surface.

Unpack all packages of hardware.

Place the Right Armrest (B) with its inside facing skywards.

Put the Backrest(A) against the Right Armrest(B), make the metal rod on the Backrest(A) insert into the MOUNTING POSITIONS of the Right Armrest(B) as picture 1 shows.

Then attach Backrest(A) and Right Armrest(B) together with hardware as picture 2 shows.

Use an Allen Key(5) to partially tighten these.

**Do not fully tighten the bolts.**

**It can happen that some of the PE wicker covers the bolt points, preventing easy assembly the PE wicker should not be cut but only moved away from the mounting positions.**

## Step 2

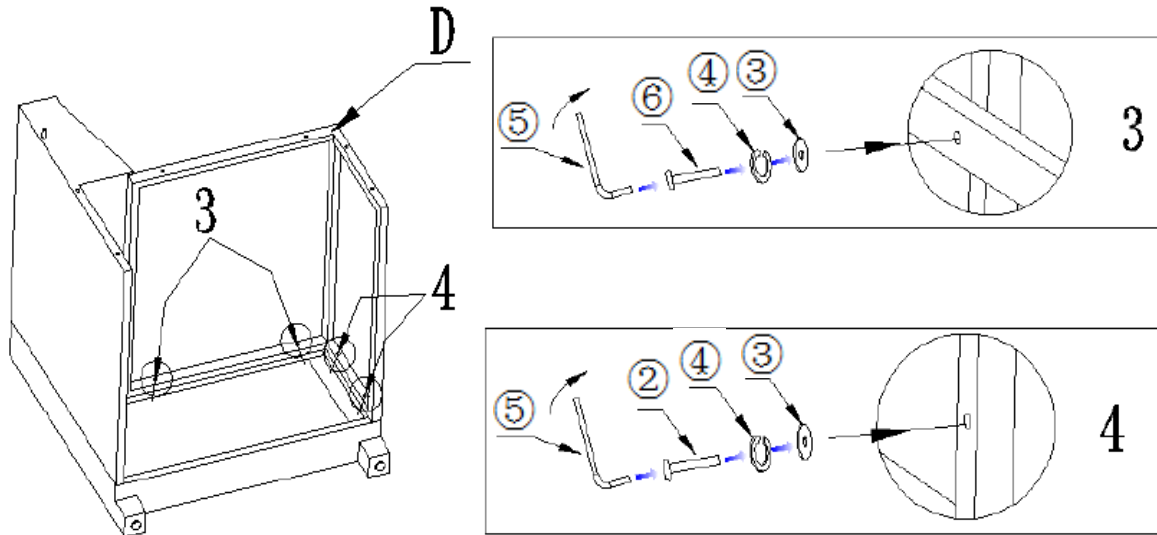

Place the Seat (D) between the Right Armrest(B) and Backrest(A).  
Attach the Seat(D) to the Right Armrest(B) with hardware as picture 3 and 4 shows.  
Use an Allen Key(5) to partially tighten these.  
**Do not fully tighten the bolts.**

## Step 3

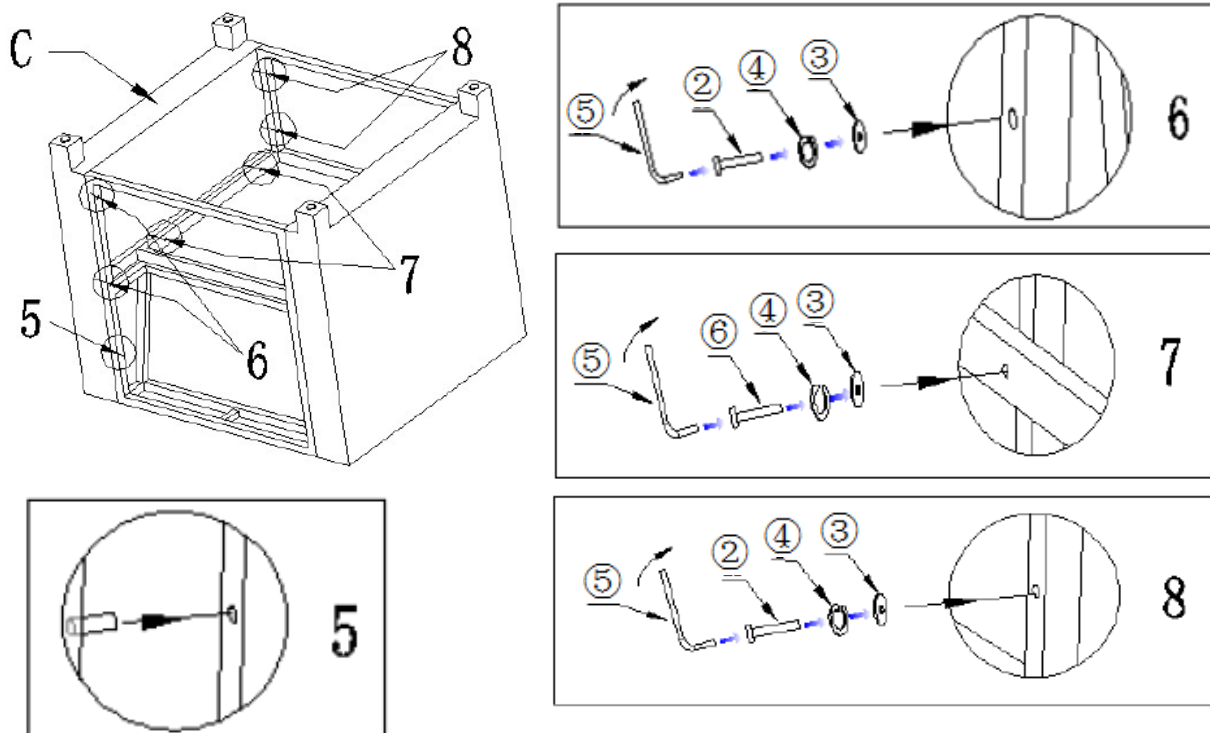

Place the Left Armrest (C) against the Backrest(A) and Seat(D).  
Make the metal rod on the Backrest(A) insert into the MOUNTING POSITIONS of the Left Armrest(C) as picture 5 shows.  
Attach the Left Armrest(C) to Backrest(A) with hardware as picture 6 shows.  
Attach the Left Armrest(C) to Seat(D) with hardware as picture 7 and 8 shows.  
Use an Allen Key(5) to partially tighten these.  
**Do not fully tighten the bolts.**

## Step 4

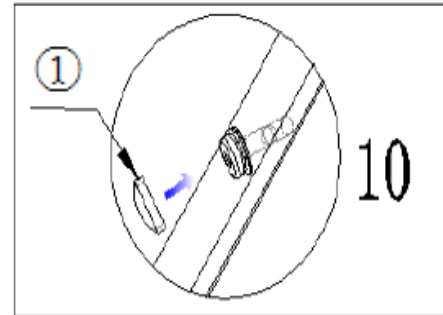
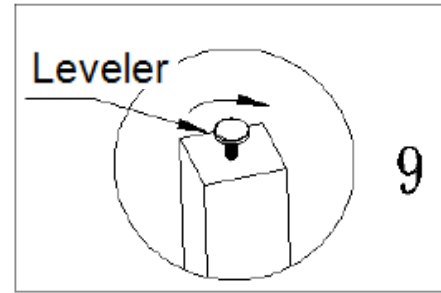
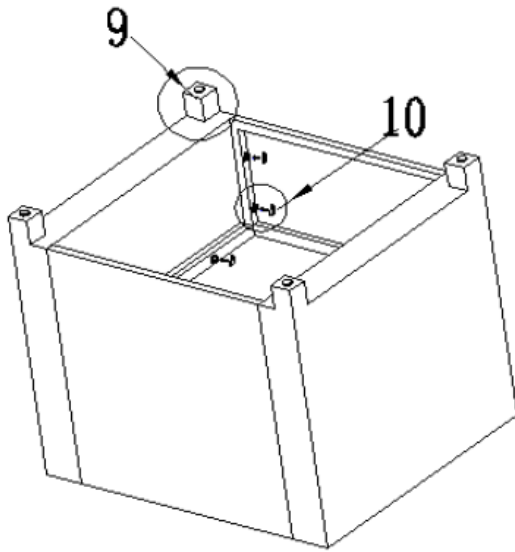

Tighten all bolts completely.  
Put the Plastic Cap(①) to cover the bolt heads, adjust the Leveler to ensure good stability.



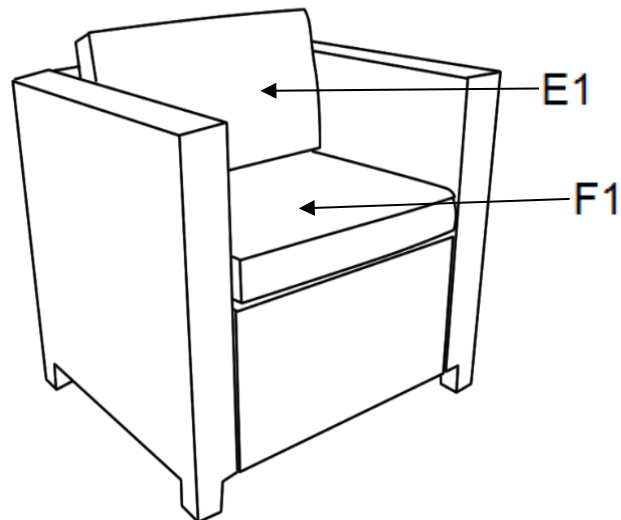

















## Step 5



Put the Seat Cushion(F1) & Back Cushion(E1) on the Chair  
It is ready for use.

**This Chair can only be used on a flat, level surface.**

## Care & Maintenance

-   ● Do not put hot items directly on furniture surface
  -   ● Do not clean furniture with harsh cleansers or polish.
  -   ● To obtain the longest lifespan of your outdoor products, minimizing exposure to direct sunlight is recommended.
  -   ● Children should not climb or jump on the furniture.
  -   ● Do not write on furniture without a padded barrier to protect the surface.
  -   ● To obtain the longest lifespan of your outdoor products, avoid extended and lengthy exposure to rain, snow, and direct sunshine. Whenever possible cover the product and /or place under patio or awnings.
  -   ● Not for commercial use. For residential use only .
  -   ● Stains may be removed with mild soap solution and damp cloth.
  -   ● Keep away from sources of ignition.
- 
-   ● Dust and pick-up spills using a clean, non-colored, lint-free cloth.