



INSTRUCTIONS D'ASSEMBLAGE
ASSEMBLY INSTRUCTIONS

TABLE DE SALON -
44"L / METAL CHROME AVEC VERRE TREMPE

COFFEE TABLE -
44"L / CHROME METAL WITH TEMPERED GLASS



POUR DE L'ASSISTANCE OU POUR COMMANDER
DES PIÈCES CONTACTEZ NOTRE DÉPARTEMENT
DE SERVICE À LA CLIENTÈLE.

FOR ASSISTANCE OR TO ORDER PARTS
CONTACT OUR CUSTOMER SERVICE DEPARTMENT

LISTE DES PIÈCES
PARTS LIST

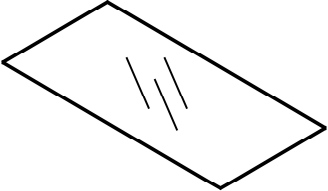
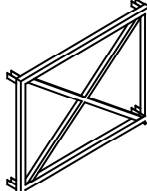
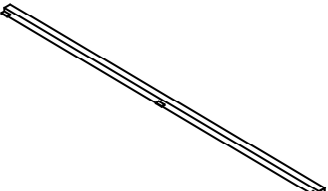
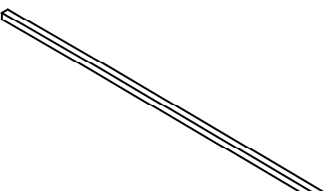
PIÈCE / PART #	IMAGE	DESCRIPTION	QTY / QTÉ
1		GLASS TOP SURFACE EN VERRE	1
2		METAL LEG PATTE EN METAL	2
3		CROSSBAR BARRE TRANSVERSALE	2
4		CROSSBAR BARRE TRANSVERSALE	2

LISTE DES PIÈCES DE MONTAGE
HARDWARE LIST

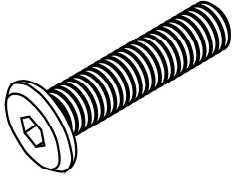
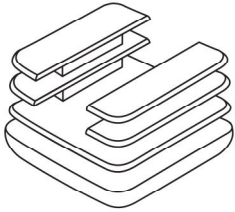
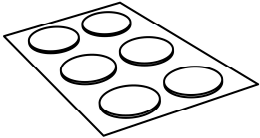
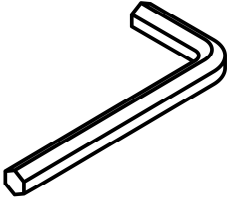
PIÈCE / PART #	IMAGE	DESCRIPTION	QTY / QTÉ
A		ASSEMBLING BOLT - Ø1/4" X 1/2" BOULON D'ASSEMBLAGE - Ø1/4" X 1/2"	16
B		FLOOR PROTECTOR - 3/4" X 3/4" PROTECTEUR DE PLANCHER - 3/4" X 3/4"	4
C		TRANSPARENT RUBBER - Ø3/8" CAOUTCHOUC TRANSPARENT - Ø3/8"	6
D		HEX KEY CLÉ HEXAGONALE	1

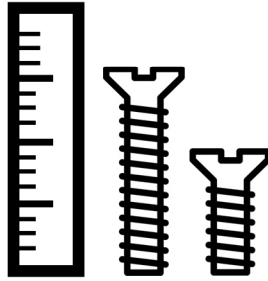

OUTIL DE VÉRIFICATION DE DIMENSIONS DES PIÈCES
HARDWARE DIMENSIONS VERIFICATION TOOL

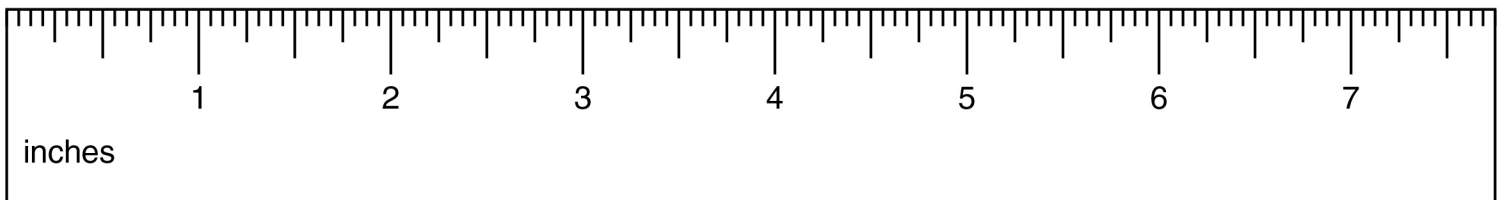

ÉTAPE / STEP 1

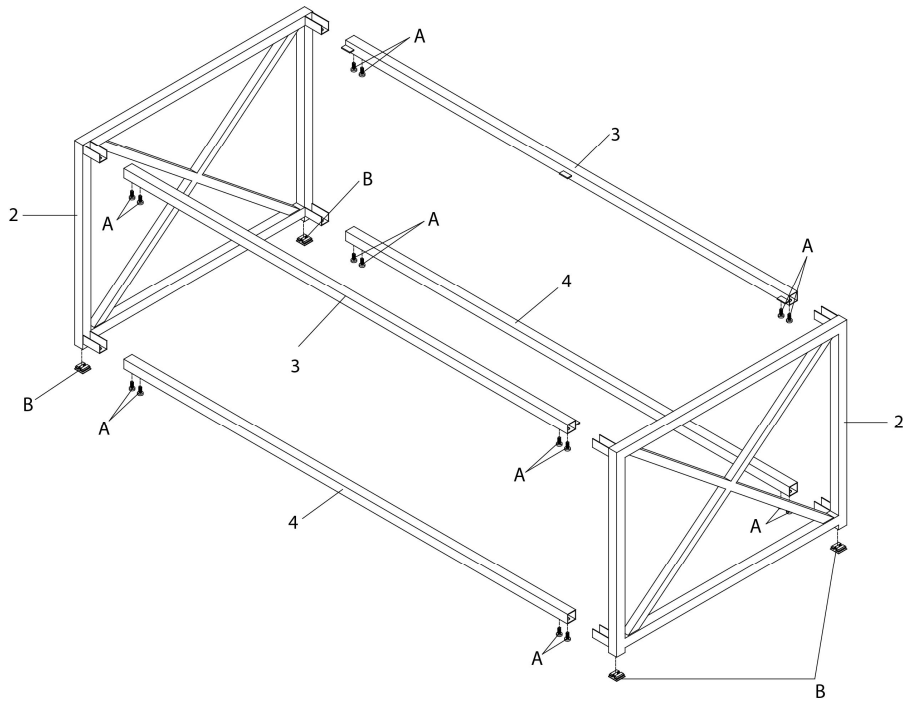

ÉTAPE / STEP 2

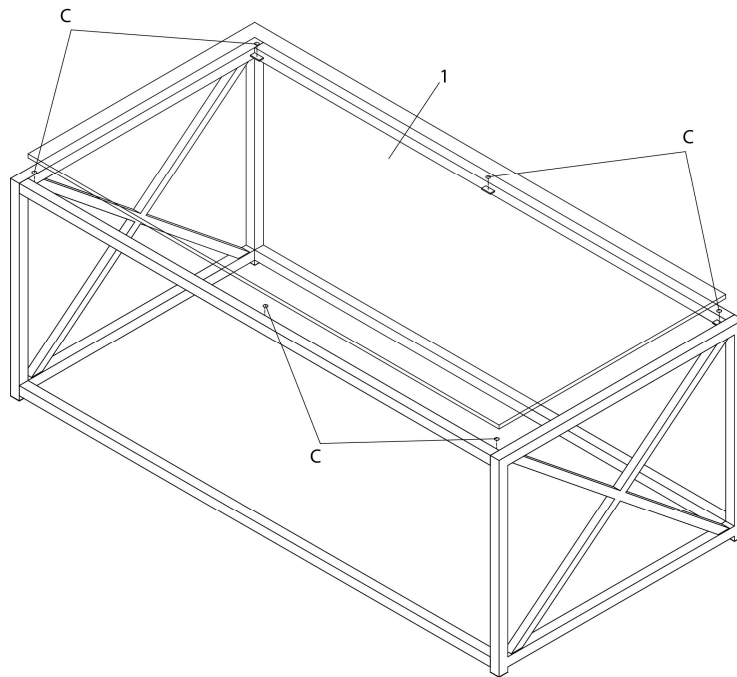

ÉTAPE / STEP 3

