

Assembly Instructions

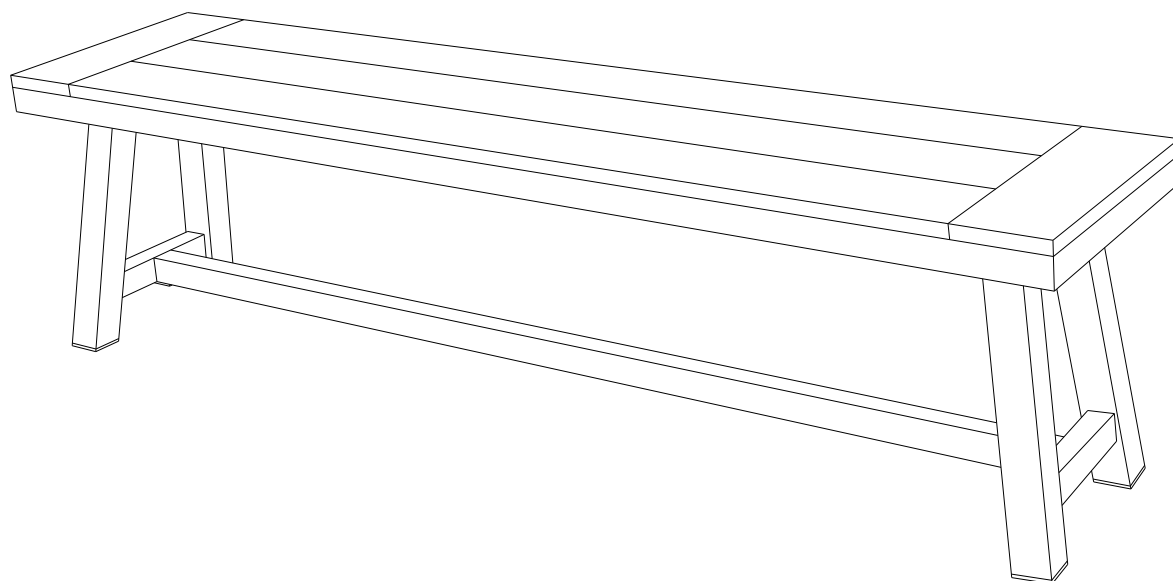

BENCH

CAUTION: You must read this before you proceed.





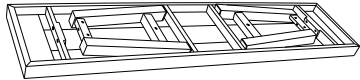

CAUTION : This Bench is NOT a TOY. Keep your child / children at bay in the process of assembly.
For turning the bench and to prevent damage to the bench, 02 persons may be needed to execute this action.

Parts List

| No. | Picture | Description | Qty |
|-----|---|---------------|-----|
| A |  | Bench | 1 |
| B |  | Leg Connector | 1 |

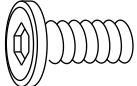
Hardware

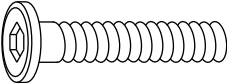
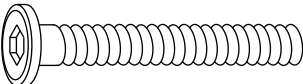
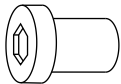
Bench Hardware

| No. | Picture | Description | Qty |
|-----|---|-----------------------------------|-----|
| ① |  | Short Bolts (M8x20mm) | 3 |
| ② |  | Big Flat Washers (M8.5/16x2mm) | 3 |
| ③ |  | Middle Bolts (M6x38mm) | 5 |
| ④ |  | Long Bolts (M6x55mm) | 3 |
| ⑤ |  | Sleeve Nuts (M6x18mm) | 5 |
| ⑥ |  | Small Flat Washers (M6/16x1mm) | 7 |
| ⑦ |  | Allen Keys | 2 |

Assembly Preparation

Before Beginning Assembly:

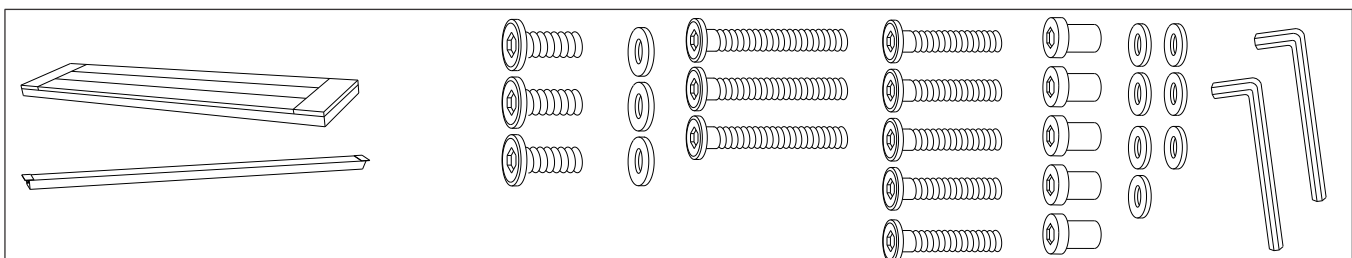

Read instructions, cover to cover.



Have 2 adults on hand for assembly.



Do not assemble on flooring or carpet.



Assemble on a clean non-marring surface (packing foam).



Save all packaging until finished.

Assembly Steps

OVERVIEW

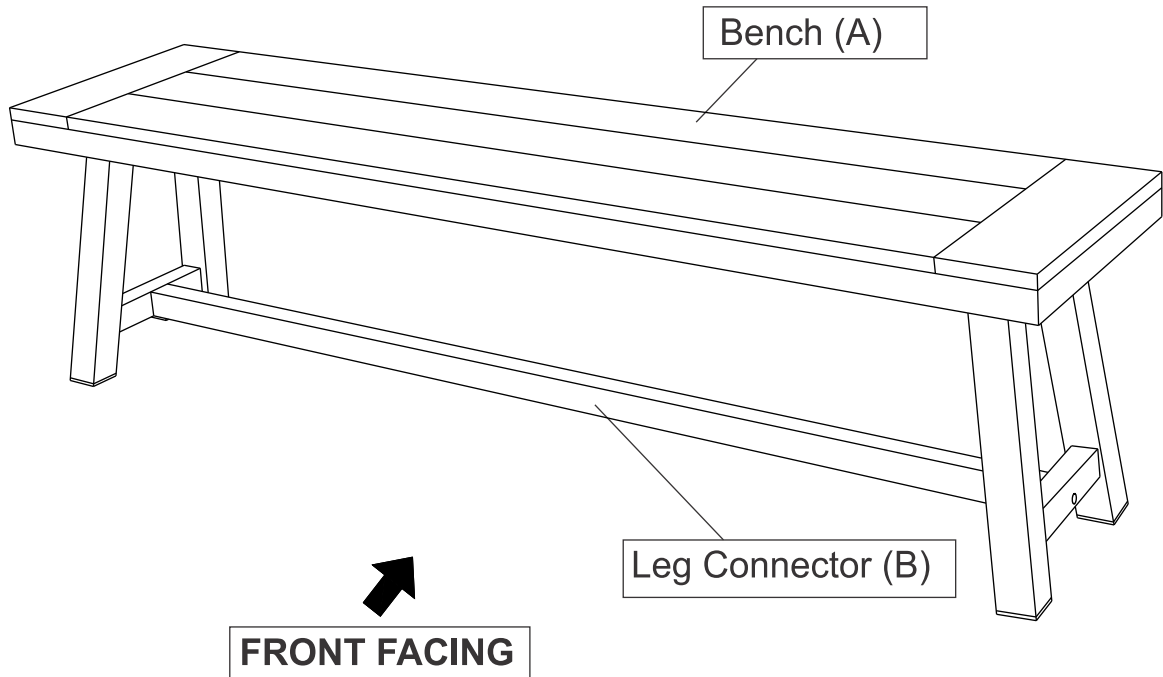

This Bench has multiple parts and may require up to 30 minutes to assemble. To give you an overview of the bench parts, the above picture is to help you put the various parts into perspective. Please read through the instructions herebelow to familiarise the parts and steps before assembly

Step 1

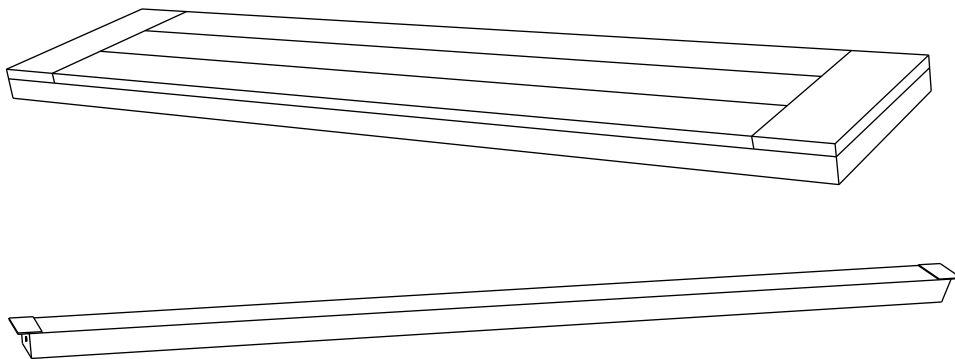

Unpack and place all parts on a clean, non-marring surface.

Assembly Steps

Step 2

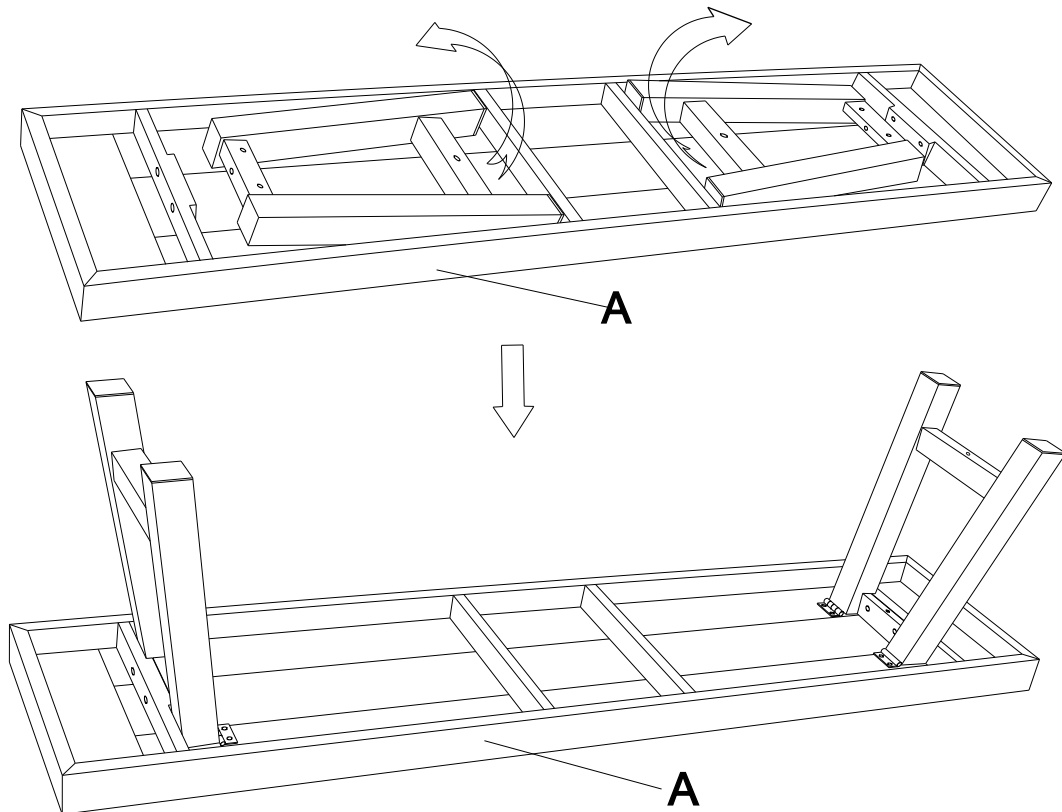

Place the Bench (A) with the fabric face skywards onto a clean, soft surface to avoid any scratches or damages to the product.

Lift legs upright in degrees until the braces are locked, as shown in the diagram.

Step 3

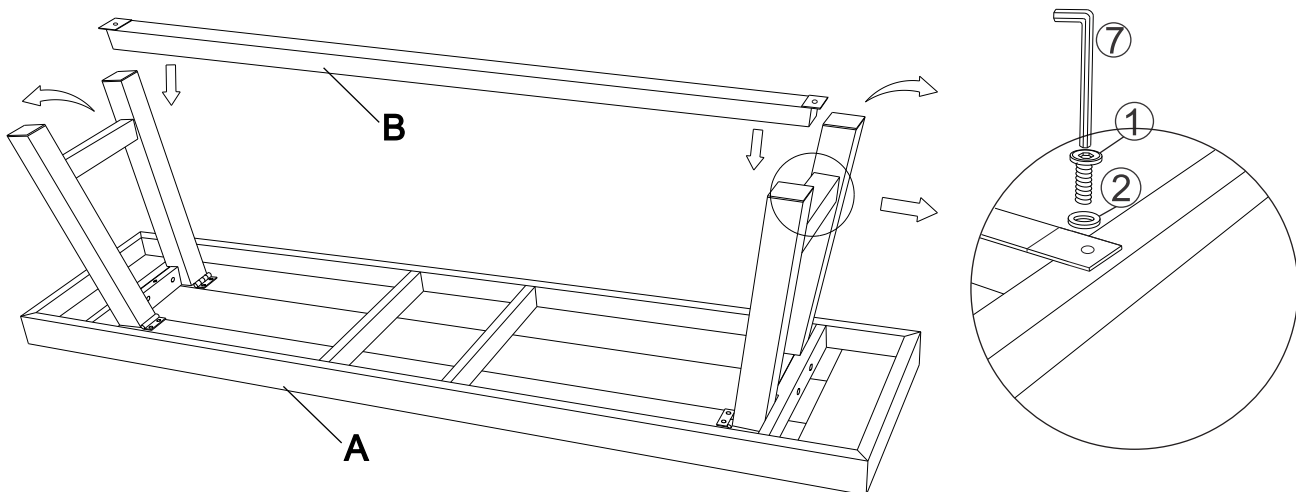

Attach the Leg Connector (B) to the Bench (A),
You may need to apply a little pressure to the Bench Legs - pushing outwards to position the Leg Connector(B).

Using the Short Bolts(1) with Big Flat washers(2), tighten the bolts by using the Allen Key(7) as shown in the diagram.

CAUTION !! DO NOT OVER TIGHTEN.

OVER TIGHTENING COULD LEAD TO DAMAGE OF THE PRODUCT.

TIGHTEN BOLTS IN A SEQUENTIAL MANNER, UNTIL SECURE AND STABLE.

Assembly Steps

Step 4

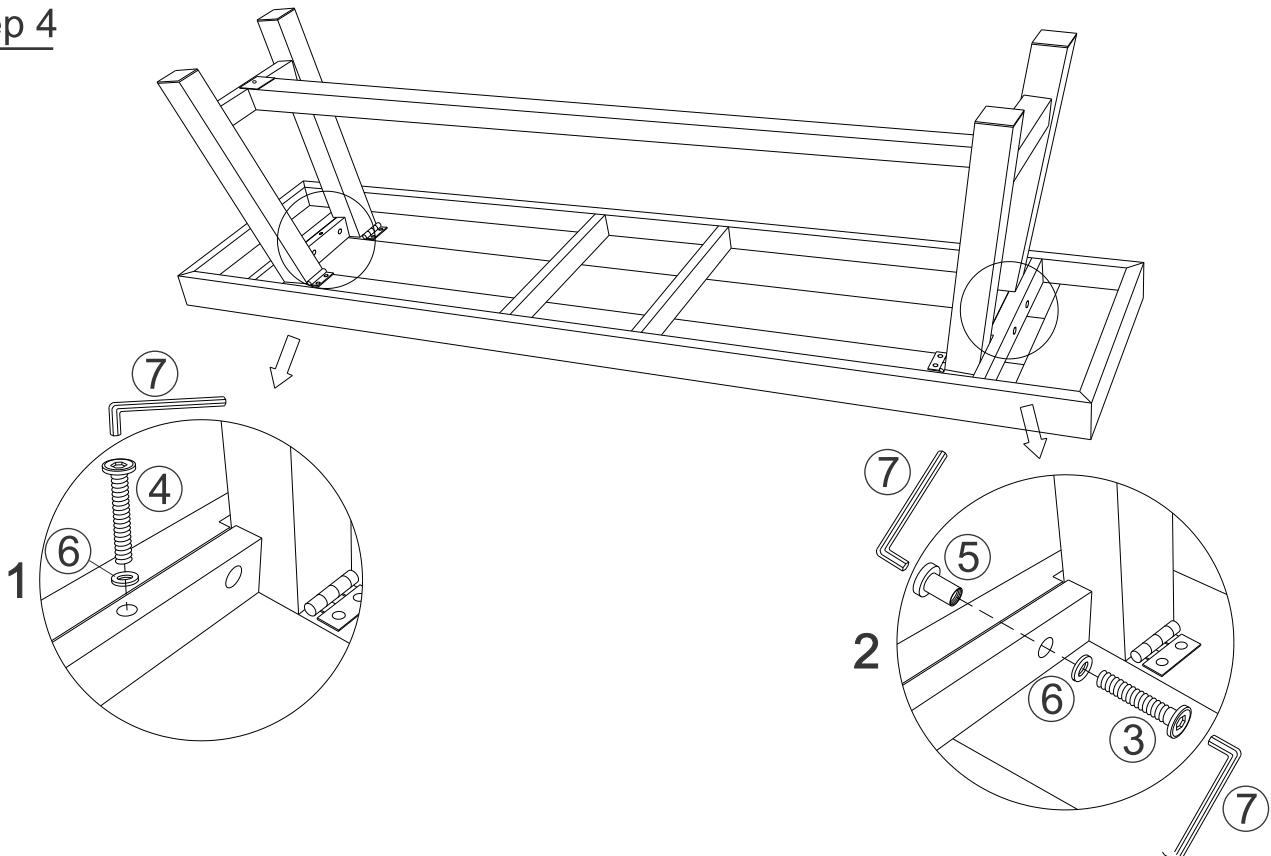

Loosely affix by using Long Bolts (④) with Small Flat Washers (⑥), as shown in the picture (1) and Middle Bolts(③) & Small Flat Washers(⑥) with Sleeve Nuts(⑤), as shown in the picture (2). Tighten with using the Allen key (⑦).

NOW, go back to all bolts previously loosely fasten, drive in and tighten all bolts in sequential manner. This sequential manner will reduce possible distortion of frame.

CAUTION !! DO NOT OVER TIGHTEN.

OVER TIGHTENING COULD LEAD TO DAMAGE OF THE PRODUCT.

SLOWLY TIGHTEN ONLY UNTIL SECURE AND STABLE.

Step 5

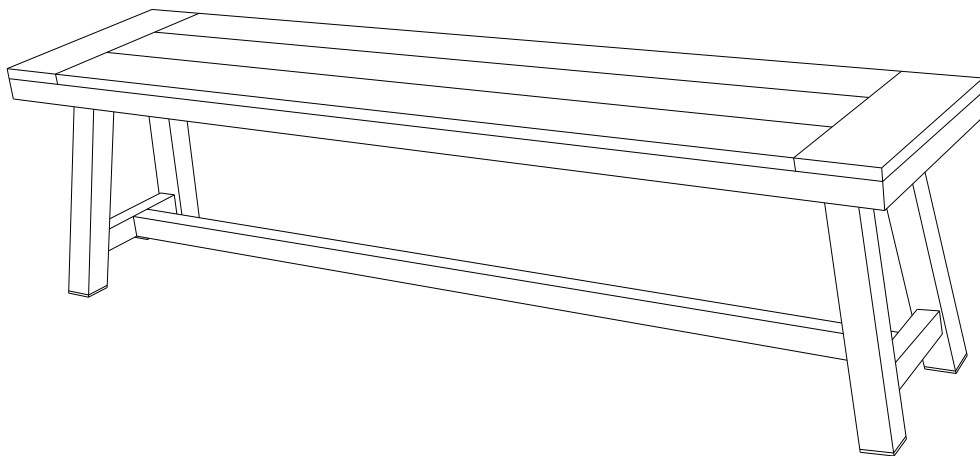









Now, in a sequential manner, drive in and fully tighten all bolts.

Thereafter, turn the bench right way up.

The Bench now is ready to be used.

Caution: This Bench can only be used on a flat, level surface.

Care & Maintenance

-  Do not put hot items directly on furniture surface.
-  Do not clean furniture with harsh cleansers or polish.
-  To obtain the longest lifespan of your outdoor products, minimizing exposure to direct sunlight is recommended.
-  Children should not climb or jump on the furniture.
-  Do not write on furniture without a padded barrier to protect the surface.
-  To obtain the longest lifespan of your outdoor products, avoid extended and lengthy exposure to rain, snow, and direct sunshine. Whenever possible cover the product and /or place under patio or awnings.
-  Not for commercial use. For residential use only
-  Stains may be removed with mild soap solution and damp cloth.
-  Dust and pick-up spills using a clean, non-colored, lint-free cloth.