

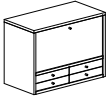





# ASSEMBLY INSTRUCTION SECRETARY DESK

No.	Part List		Qty	No.	Name of Hardware	Qty
1		Bergstrom Secretary Desk	1	A	 Bolts M6 x 30mm	6
				B	 Lock Washer M6	6
				C	 Washer M6	6
2		Table Leg	1	D	 Allen key M4	1
				E	 Anti-tip Kit Set	2

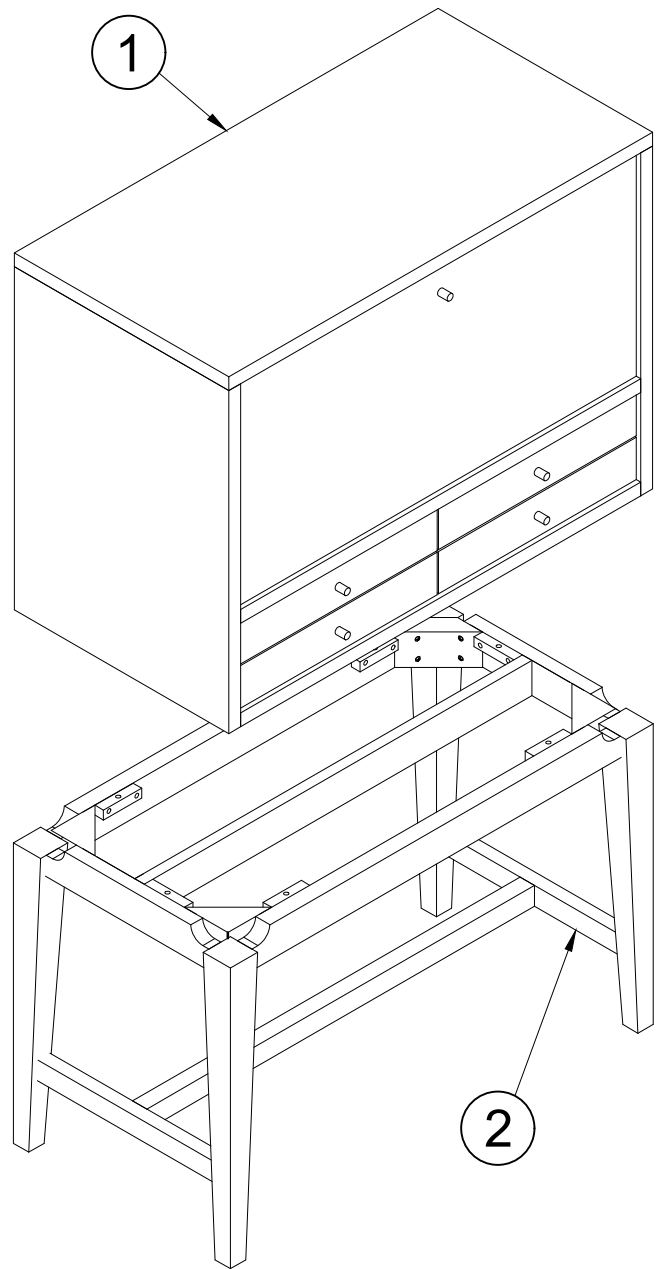
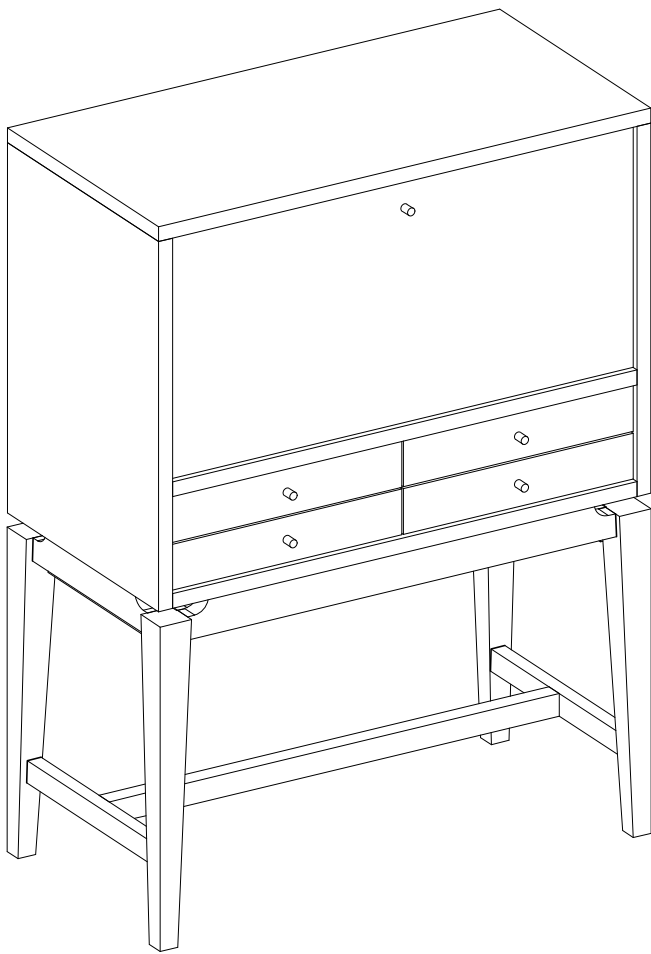

# ASSEMBLY INSTRUCTION SECRETARY DESK

Step: 1

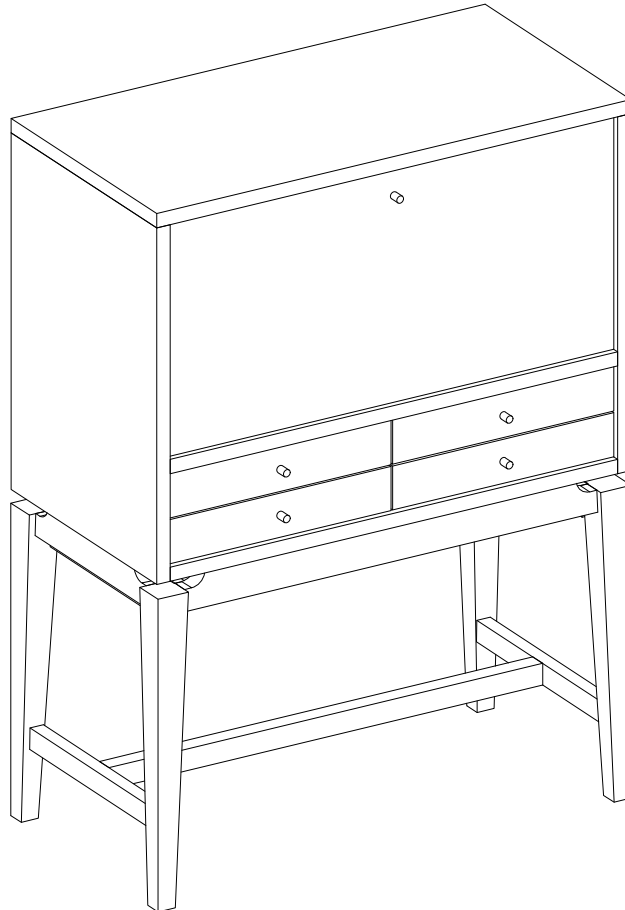
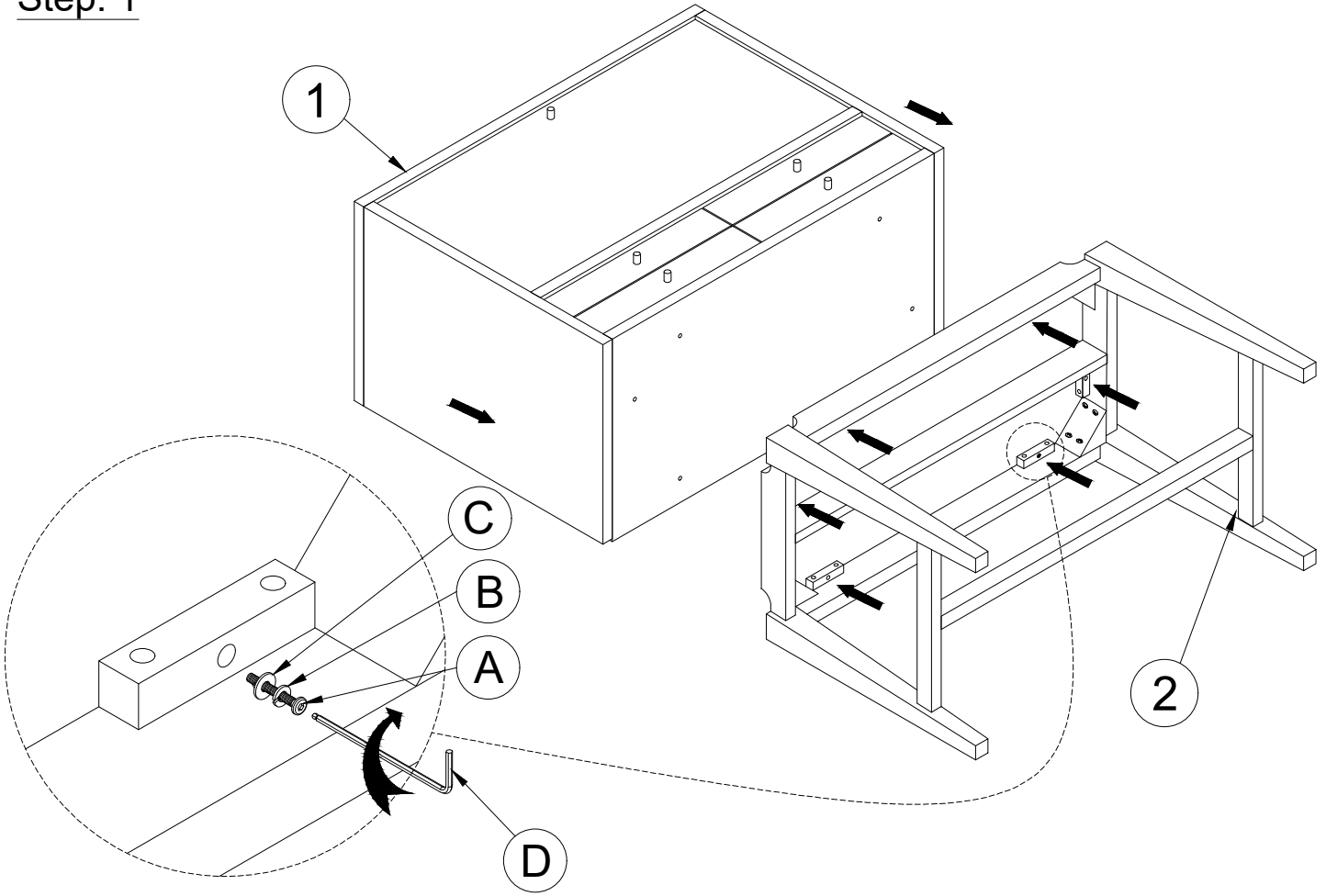

MADE IN VIETNAM

FINISH

# ASSEMBLY INSTRUCTION SECRETARY DESK

## ⚠ WARNING

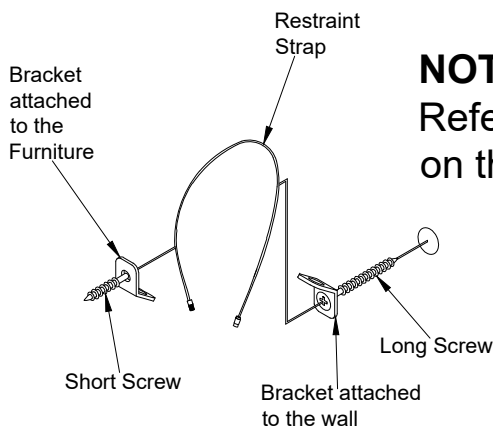
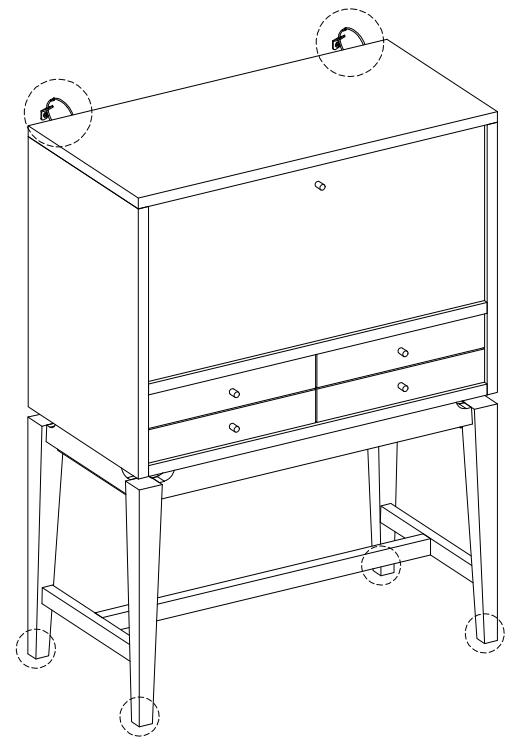
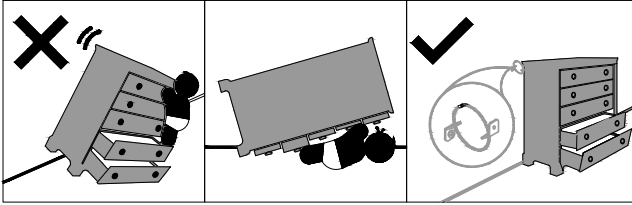

**NOTE:**  
Refer the instructions  
on the anti-tip kit bag.

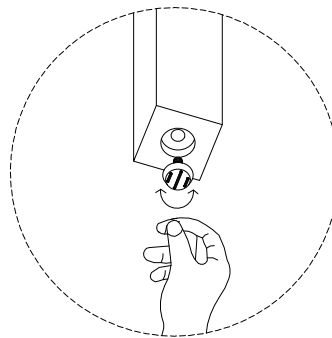

## Adjusting Floor Levelers

## Adjustable Leveler

Your furniture has been expertly crafted and pre-adjusted by professionals. However, slight shifts can occur during transportation. If you notice that the doors are not perfectly aligned or the furniture wobbles, a quick adjustment can help ensure stability and a seamless look.

## Adjust the Floor Levelers

**Check for Stability** - Place the furniture in its final position on a level surface. If it wobbles or doesn't sit evenly, the floor levelers need adjusting.

**Locate the Levelers** - These are small adjustable feet found at the bottom corners of your furniture.

**Adjust as Needed** - Using your hand or a wrench, turn the levelers clockwise to raise or counterclockwise to lower the furniture. Make small adjustments and check stability after each turn.