

© 7x7

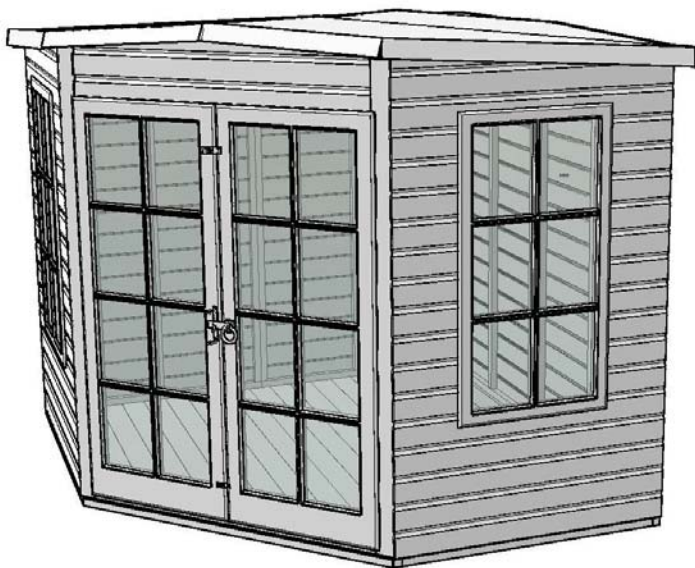

**These instructions are for your safety. Please read through them thoroughly before use .
PLEASE KEEP THIS LEAFLET FOR FUTURE REFERENCE**

Let's get started...



Important information...

Safety	03
Base and positioning	04
Warranty	04
Care maintenance & Recycling	05



In more detail...

Hardware chart	06
Parts List	07
Detailed Technical Drawing	08-11
Before you start	12
Assembly instructions	13-24

EN	For a copy of the instructions or a copy in another language please send an email or write to the address below.
F	Pour obtenir un exemplaire des instructions ou une copie dans une autre langue s'il vous plaît envoyez un e-mail ou écrire à l'adresse ci-dessous.
PL	Na kopii instrukcji lub kopii w innym języku prosimy o wysłanie maila lub pisać na adres podany poniżej.
RUS	Для получения копии инструкции или копия на другом языке, пожалуйста, отправьте по электронной почте или написать по указанному ниже адресу.
TR	Başka bir dilde talimatları veya bir kopyasını bir kopyası için bir e-posta gönderebilir veya aşağıdaki adrese yazınız.

Safety

Check that you have noted all the following instructions



- We advise the use of non slip protective gloves throughout the assembly process.
- We advise the use of steel capped protective footwear throughout the assembly process
- We advise that you use a helper to hold the glass in position whilst you nail the beading in place
- We advise the use of protective headwear and safety goggles throughout the assembly process
- Where a ladder is in use another person must hold the ladder.
- Do not attempt to work in windy conditions
- We advise the use of a scaffold tower when fitting the roof , for felting or if you cannot reach from the ground.
- Do not allow children near the tools and work area
- Follow any safety precautions quoted by the manufacturer for any equipment you use
- Check all parts before assembly
- Only use child and animal safe wood preservative
- Do not use creosote
- Allow the wood preservative to fully dry before use
- Regularly check the building for wear and tear

Important!



EVERY PRECAUTION IS TAKEN TO ENSURE THAT YOUR BUILDING HAS NO ELEMENT INCORRECTLY PLACED OR POSSIBLY HAZARDOUS, HOWEVER PRIOR TO USE PLEASE CHECK ALL SURFACES FOR THE FOLLOWING:

- (1) RAISED GRAIN, SPLINTERS: Sand down timber to smooth finish
- (2) NAIL/SCREW/PIN HEADS PROUD: Tap home to be flush with surface of timber
- (3) DAMAGED SCREW HEADS RESULTING IN SHARP SPLINTERS OF METAL: Replace
- (4) SHARP ENDS OF NAILS/ SCREWS/ PINS PROTRUDING THROUGH THE PANEL: Remove and reposition.
- (5) ENSURE ALL PARTS ARE SECURED AGAINST REASONABLE FORCE: Remove and refit
- (6) ENSURE THERE ARE NO LOOSE PARTS: Remove and refit/discard



IMPORTANT ! For your safety please read carefully the safety warnings

Preparation of base...

We recommend that the base onto which your building will stand should be at least 75mm larger in each direction than the total floor size of the building.

Actual floor area of the building: 2048mm x 2048mm

Total height clearance: 2140mm

The chosen position in your garden for your building should be excavated to a depth of 75mm to allow a base of sand, on to which paving slabs can be evenly laid. You may also use an adjustable timber base or a concrete base. Whatever base you decide upon IT MUST BE LEVEL AND FIRM.

Warranty...

10 Year anti rot warranty subject to the following -

- The building must be raised so it is not in contact with any water retaining base surface (for example grass).
- This can be achieved using a timber, concrete or slab base
- When using a concrete or slab base use damp proofing strips under the bearers
- The building must have been completely treated and sealed immediately prior to or after assembly
- The building must have been re-treated and re-sealed annually
- If your building has been pressure treated or has any pressure treated parts additional treatment need not be applied (except for aesthetic purposes)
- Wood is a natural product and therefore the following are excluded from the warranty
 - Colour changes
 - Warping
 - Splitting

The following are also excluded

- Damage resulting from poor assembly
- Poor treatment application
- Poor care and maintenance
- Changes to the design
- Misuse
- General wear and tear

The 5 golden rules of care

- (1) (1) Ensure your base is level and firm
- (2) (2) Ensure the building is not sitting directly on the ground using damp proof membrane or the optional timber base.
- (3) (3) Ensure every piece of timber and surface, especially that is hidden upon assembly is treated with a top quality wood preservative at least twice (see note on pressure treated buildings in warranty section). Turn the panels upside down whilst painting so the treatment runs into the seams.
- (4) (4) Garden buildings are not waterproof, therefore we recommend you seal between all the panels with a silicone based sealant .
- (5) (5) Regularly check your roofing felt for weather damage and leaks

The 7 golden rules of maintenance

- (1) Re apply the timber treatment annually. (see note on pressure treated buildings in warranty section)
- (2) Visually check for weather damage
- (3) Check and replace if necessary any Silicone sealant if used on your building.
- (4) Check the roofing material for wear
- (5) The doors and windows may require periodical adjustment
- (6) Ensure your building is well ventilated especially during hot weather
- (7) During extremely hot periods humidify your building to prevent the timber from drying out .



packaging

1. Pallet and timber widely recycled
2. Cardboard widely recycled
3. Plastic strapping subject to local regulations
4. Plastic sheeting subject to local regulations



Building

1. Timber widely recycled
2. Metal fixings widely recycled
3. Glass widely recycled
4. Roofing felt not currently recycled

Hardware Chart Scale 1:1

09mm Felt Nail
(A0266) x150



16mm Panel Pin
(A0024) x224

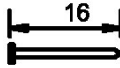

40mm Round head nail
(A0025) x55

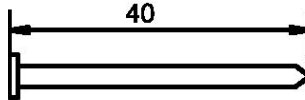

Black 25mm
Posi-drive screw
(A0031) x12

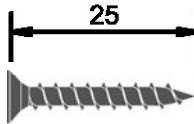

25mm Posi-drive screw
(A0032) x94

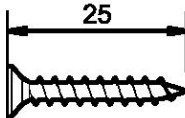

60mm Posi-drive screw
(A0035) x63

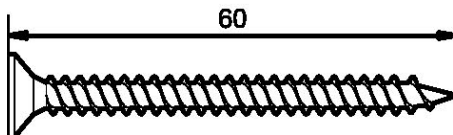

Description

(part No) qty

Fascia bag contents

Fascia

(A1395-1120mm) x02

(A1396 -800mm) x02

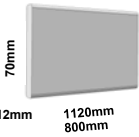

Door & Window Hinges

(A0013) x10

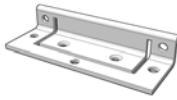

Casement set

(A0038) x02

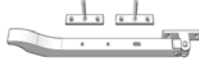

Door Bolt

(A0014) x02

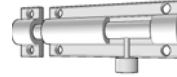

Gate latch set

(A0015) x01



Turn button

(A1388) x02



Cover strips 1940mm

(A1393) x04

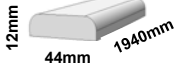

Profiled cover strip

(A1394) x02

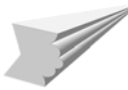

Diamond

(A0019) x01



Beading

(A0021) x56

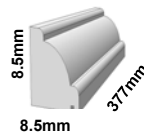

Beading

(A0022) x56

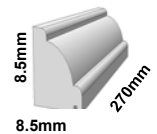

Stacked parts list

Doors

LH A1314

RH A1313

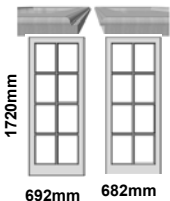

Window insert

(A0367) x02

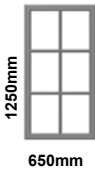

Window Panel LH

(A1319) x01

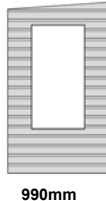

Window Panel RH

(A1320) x01

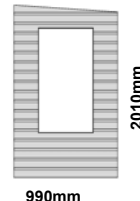

Floor panel

(A1382) x01

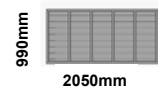

Floor panel

(A1383) x01



Plain Panel

(A1384) x04

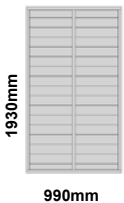

44s framework

Square corner post

(A1385) x01

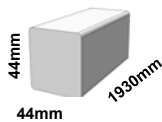

Angled door post

(A1386) x02

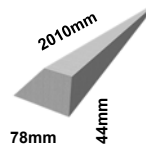

44D framework

Door step

(A1387) x01

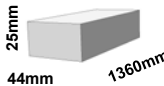

Felt strips

3.5m (A0054) x02

(1.3m (A0126) x01

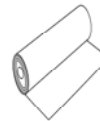

Gable Panel;

(A1318) x01

(A1318) x01

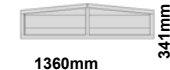

Large Roof panel LH

From inside looking forward

(A1389) x01

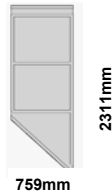

Large Roof panel RH

From inside looking forward

(A1390) x01



Triangle Roof panel LH

From inside looking forward

(A1391) x01



Triangle Roof panel RH

From inside looking forward

(A1392) x01

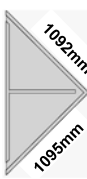

Glazing

(A0020) x28

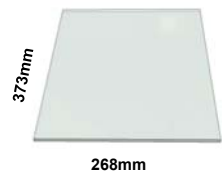

In more detail.....

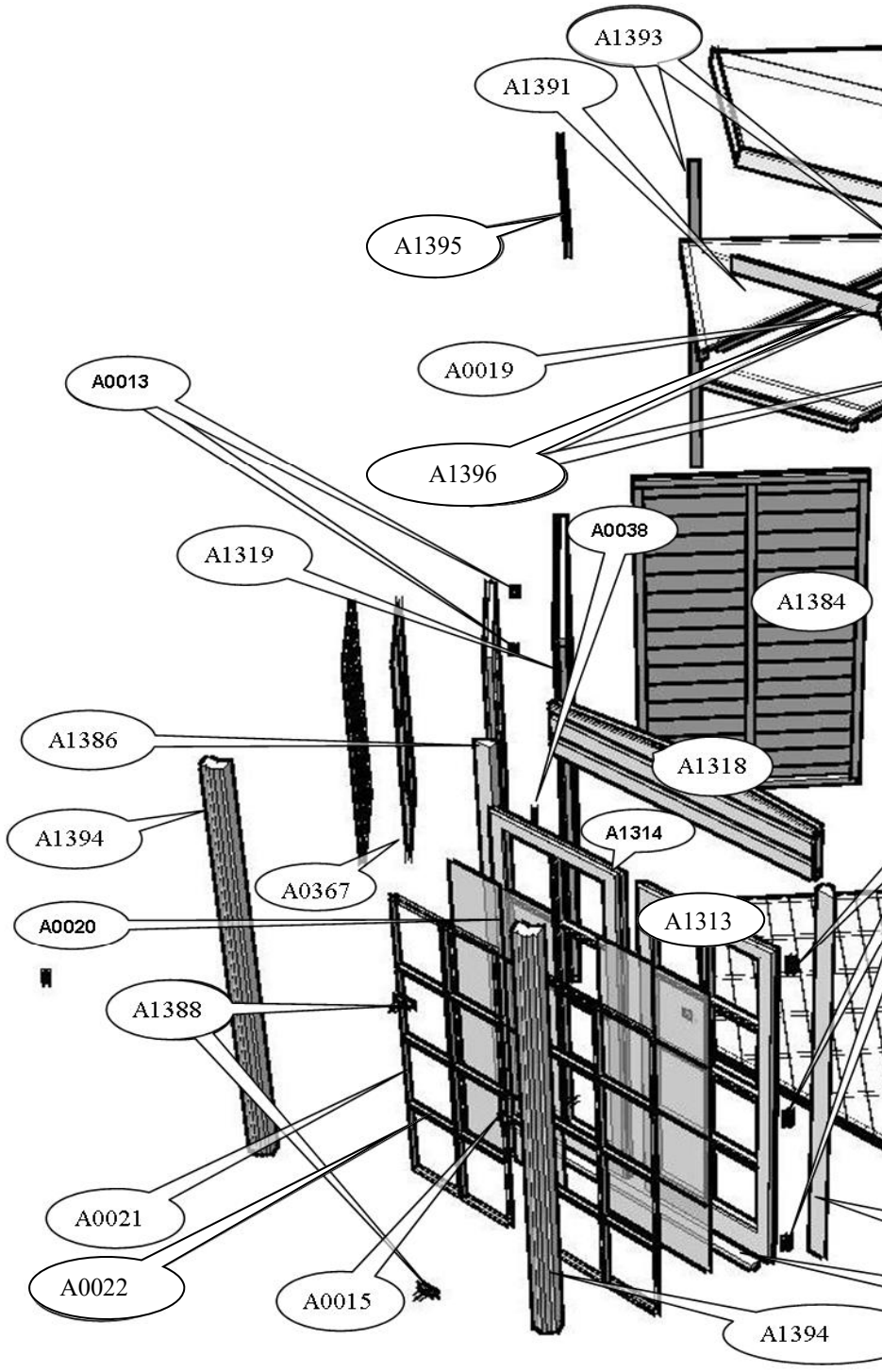

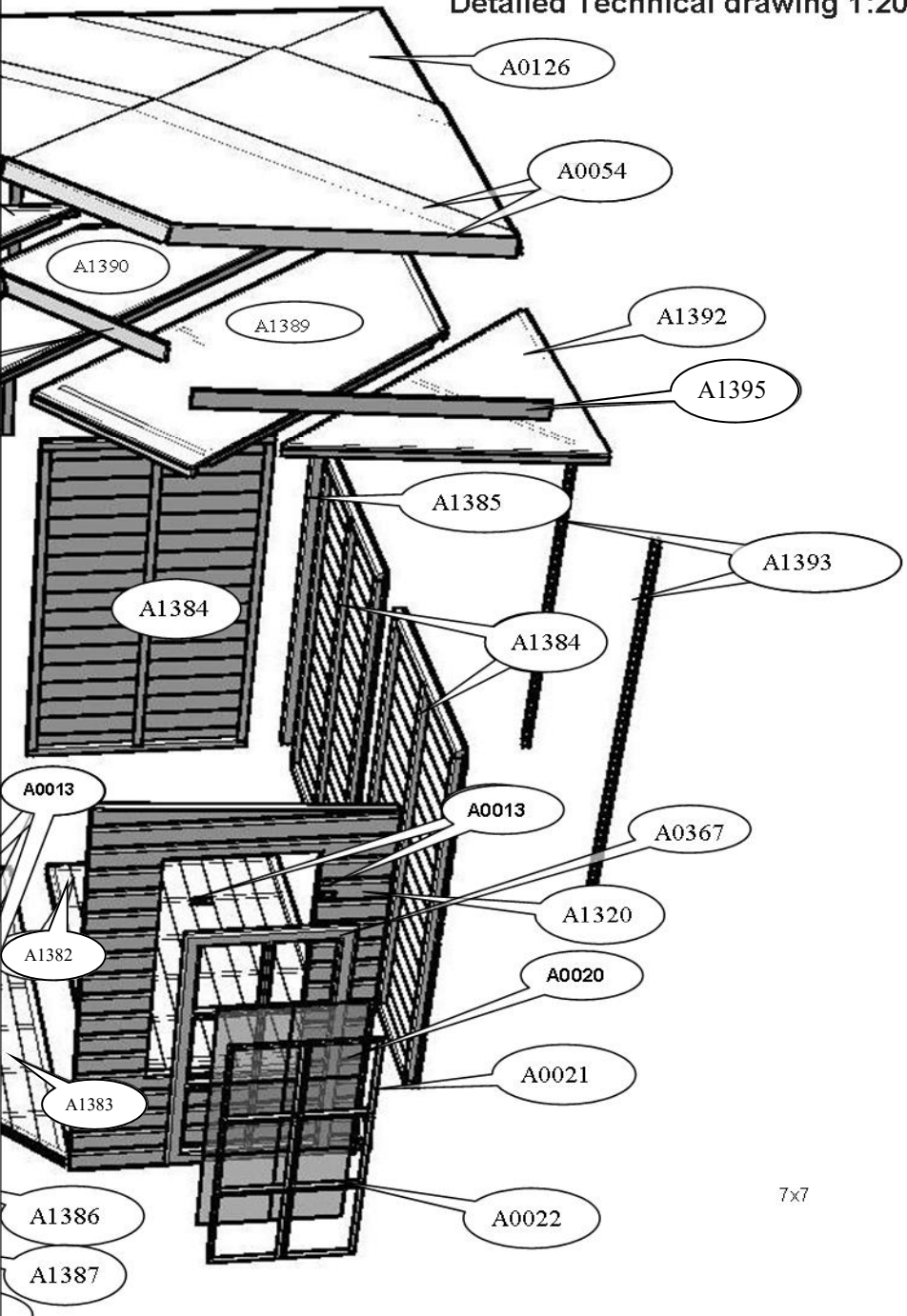

In more detail.....

7x7

In more detail.....

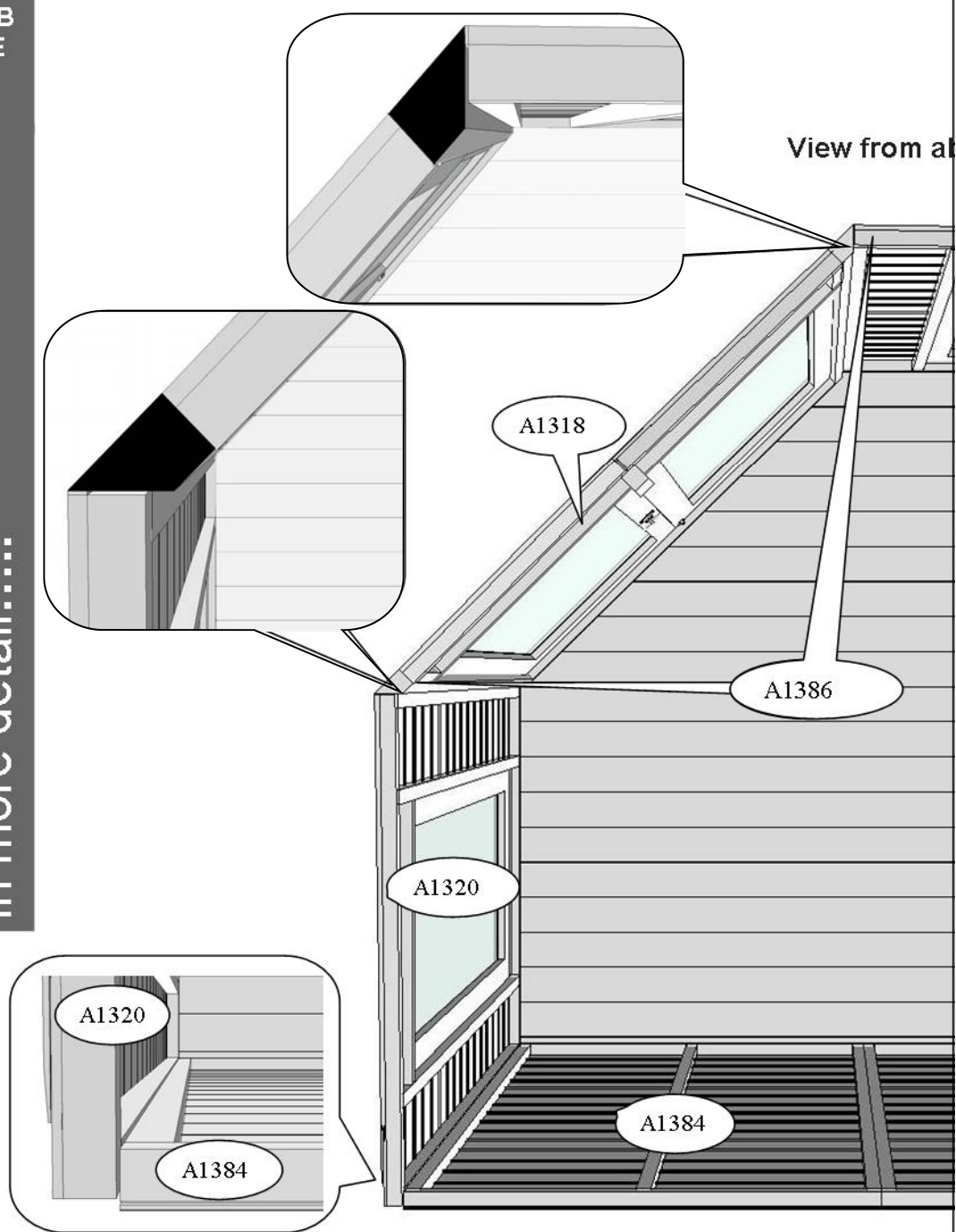

above and enlarged corner details

7x7

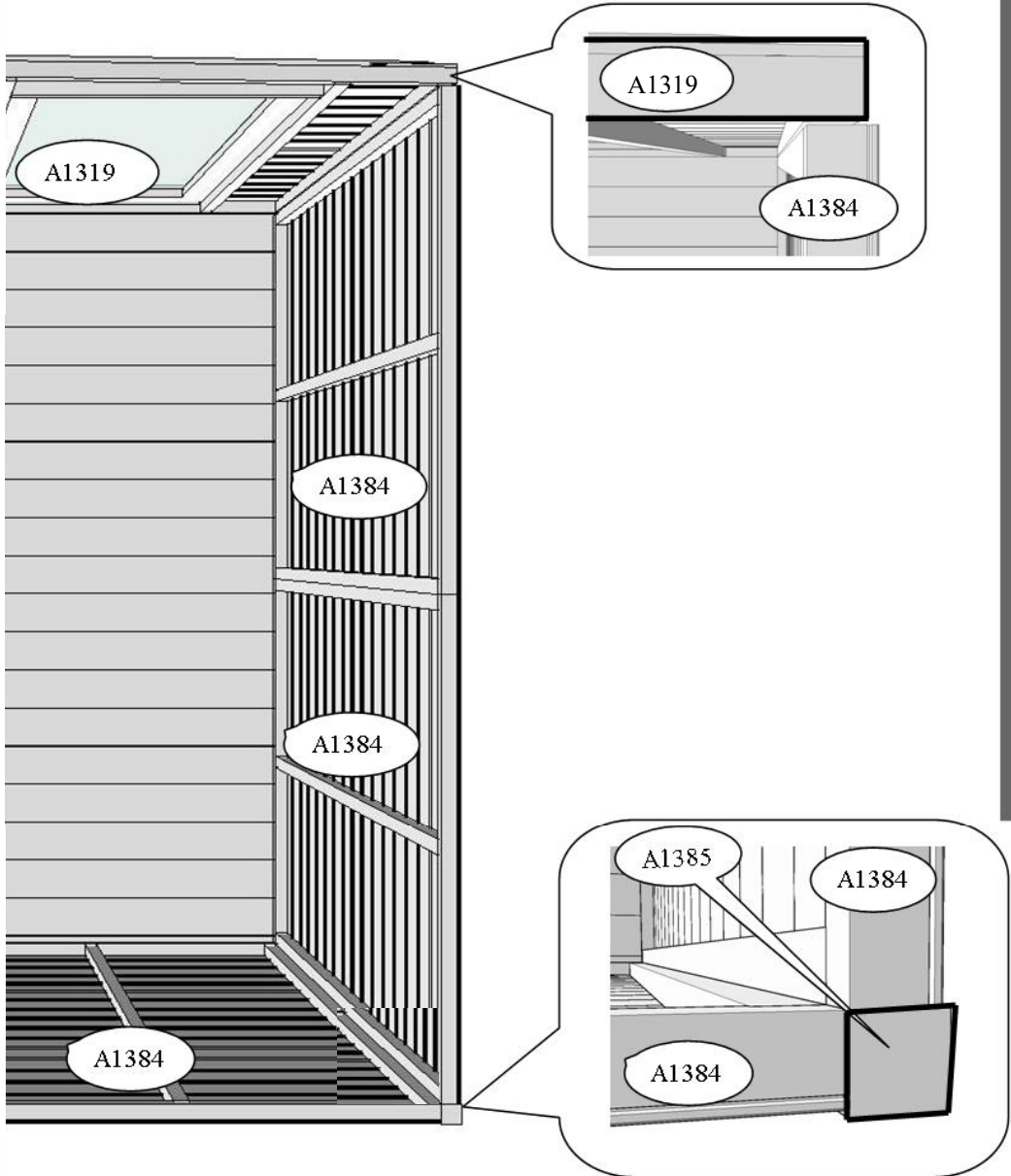

7x7

In more detail.....

Things to check before you start

- ✓ Ensure your base is ready– See page 4
- ✓ Check all parts as listed in the parts lists
- ✓ Read the instructions fully before starting work
- ✓ Follow all the health and safety guidelines
- ✓ Treat as described on page 5 golden rules of care



When you see the drill icon
 Only ever drill through the first piece of framework which will be a pilot hole for the screw to attach the second piece of framework
The required drill bit size is shown with the icon.

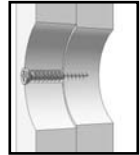
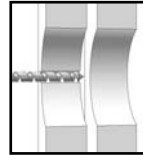

You will need



- Hammer



- Spirit level



- Ladder



- 1mm, 3mm 5mm & 8mm drill bit



- Drill



- Tape measure & Ruler



- Sand paper



- Gloves



- Saw

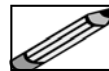

- Pencil



- Goggles

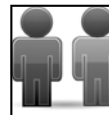

- A helper for some tasks



- Screwdriver

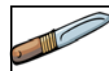

- Sharp knife

Assembly

These instructions are for your safety. Please read through them thoroughly before use .
Treat all the parts before assembly –see page 5

GB-IE

Attach the smaller inner part of 3 of the hinges on the long edge of each of the doors.

01

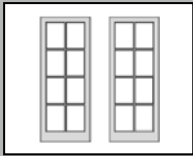

Doors
(A1314 A1313)

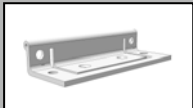

Door hinge
(A0013)x06

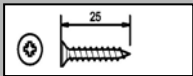

25mmScrew
(A0032)x12

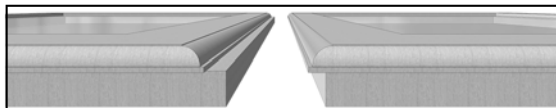
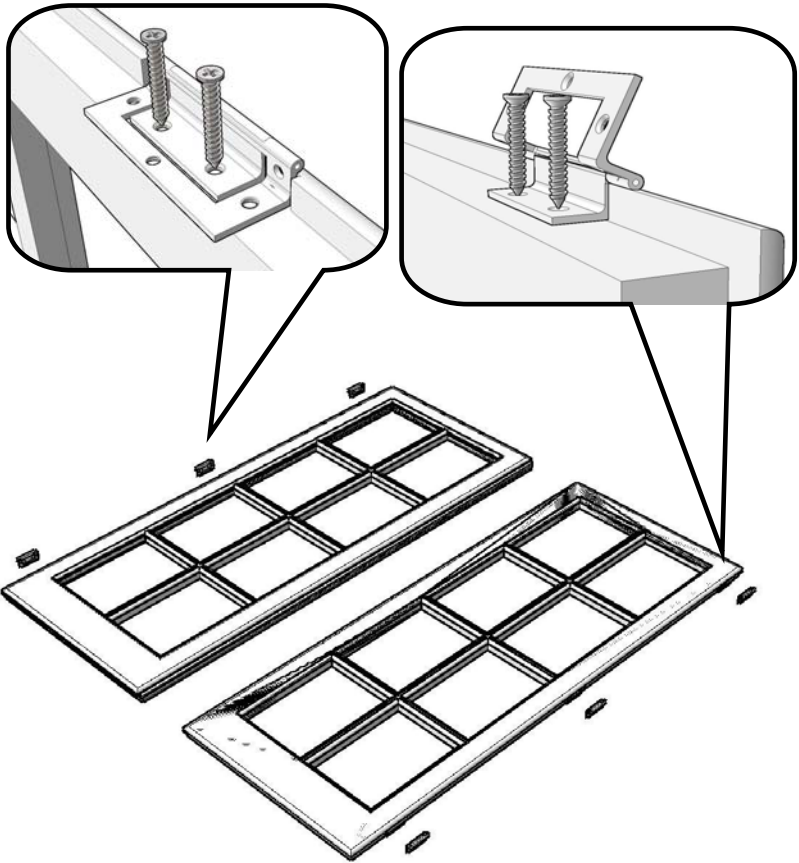

A1314
Secondary door
Bolted

A1313
Primary door
Opening first

View on bottom of doors

GB-IE

Try the window in position in the panel to check that you have it the correct way around. The hinges fit the top of the window.

02



Window insert
(A0367) x02

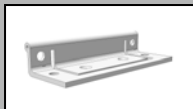

Hinge
(A0013) x04

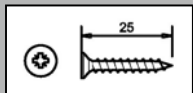

25mm Screw
(A0032) x08

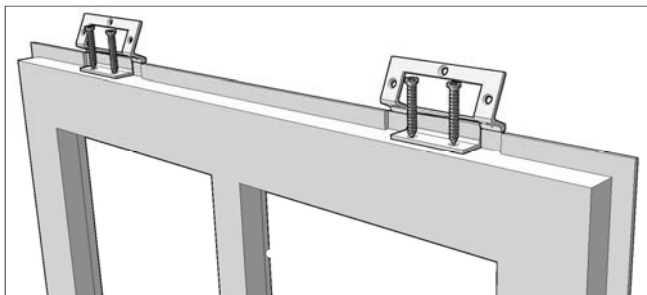
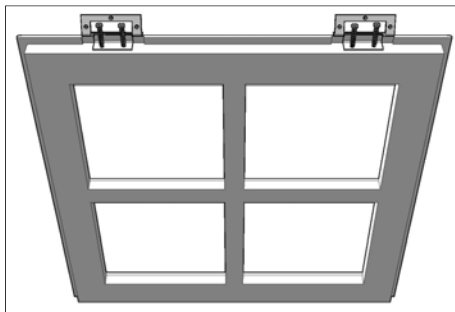
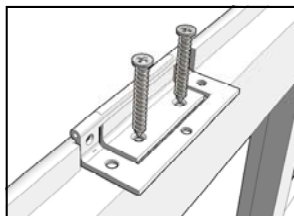

GB-IE

Position the window insert in the aperture and screw the inner screw holes that are just visible first. Open the window and insert the remaining screws.

03

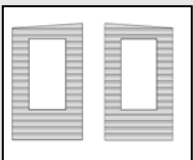

Window panels
(A1319 & A1320)

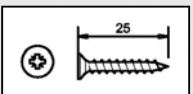

25mm Screw
(A0032) x20

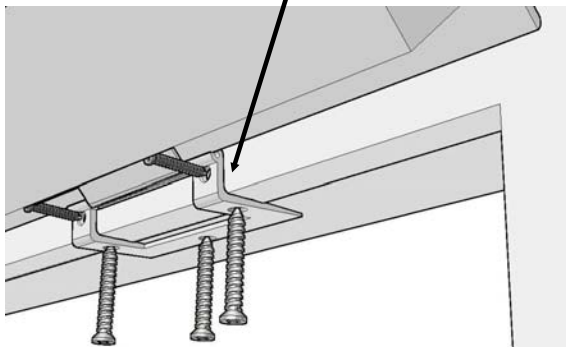
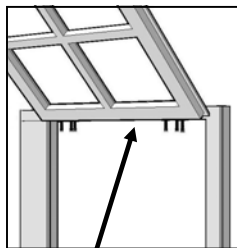

14

GB-IE

Case ment stay and pins must fit together loosely. Fix the case ment stay to the window insert first. Then mark and fix the pins .

04

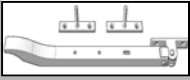

Case ment set (A0038) x02

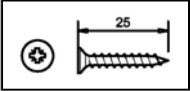

25mmScrew

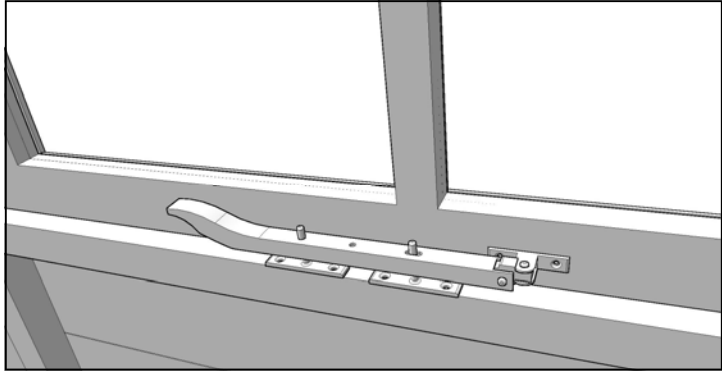

GB-IE

Stand both floor panels on edge, drill one floor panel and screw them together. Lay your floors in position on your base.

05

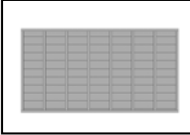
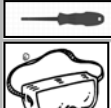
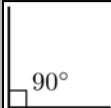

Floor (A1382) x01

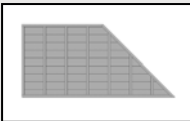

Floor (A1383) x01

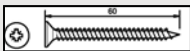

60mmScrew (A0035)x04

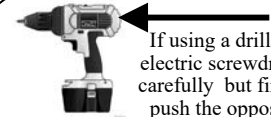
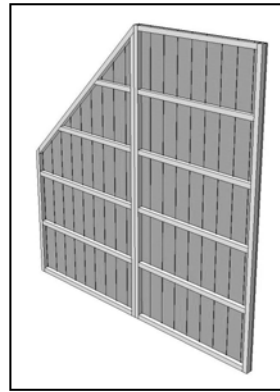
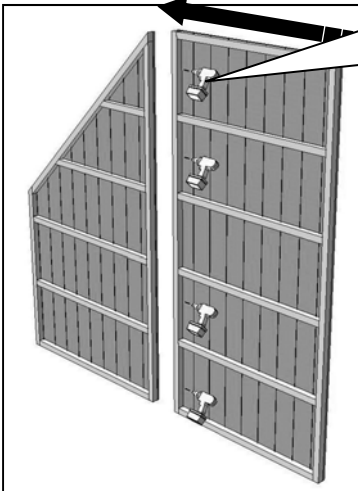

If using a drill or electric screwdriver carefully but firmly push the opposite end to the screwdriver bit into the screw head and keep the pressure on to prevent the screwdriver spinning in the screw

GB-IE Attach the plain panel "A1384" to the post "A1385" so the post is flush with the framework and the face of the cladding. At the bottom the post is flush with the framework.

06

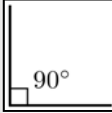

Plain panel (A1384) x01

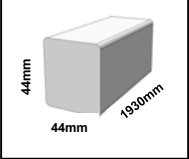

Corner post (A1385) x01

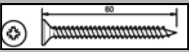

60mmScrew (A0035)x03

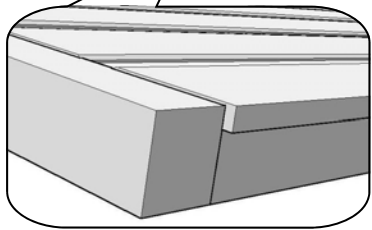
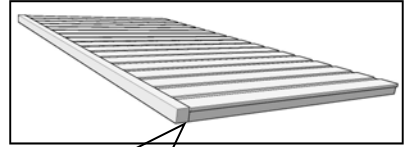
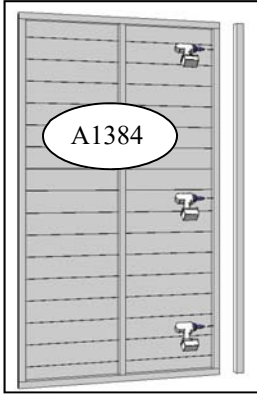

GB-IE

Place the panel from step 3 in the corner. Position & fix another "A1384" plain panel against the post as above so the post overhangs the floor and is not seen from inside the building.

07

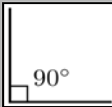

Plain panel (A1384) x01

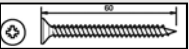

60mmScrew (A0035)x03

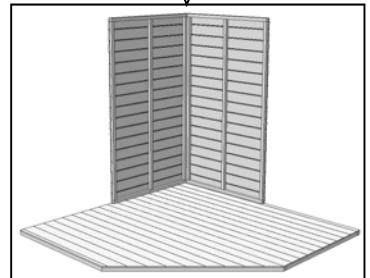
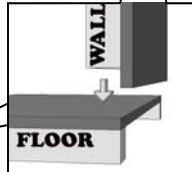
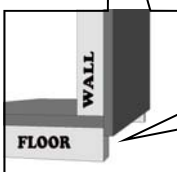
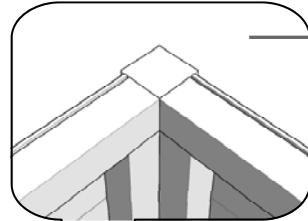
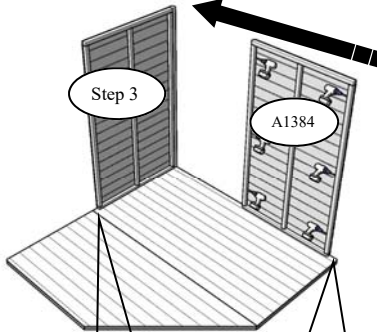

GB-IE

Add two more plain panels "A1384".
This will leave a 34mm step on both corners to the edge of the floor.

08

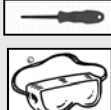
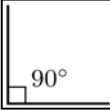

Plain panel
(A1384) x02

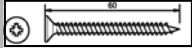

60mmScrew
(A0035)x06

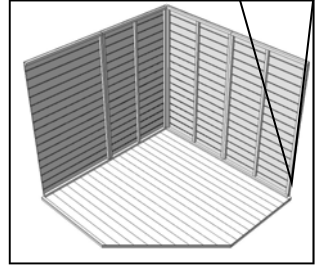
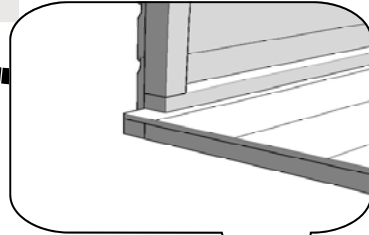
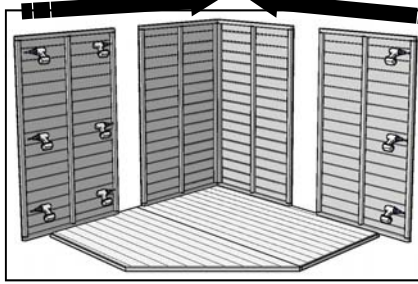

GB-IE

Position and fix the two window panels, the panels will be flush with the corners.
Drill 3 holes per window panel to fix the step 10 "A1386" angled posts

09

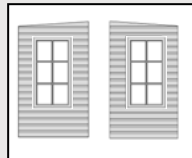
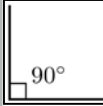
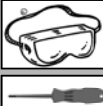

Window panels
Step 3

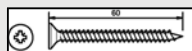

60mmScrew
(A0035)x06

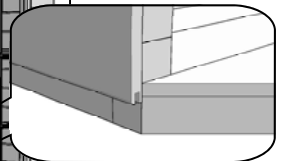
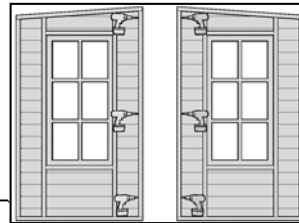
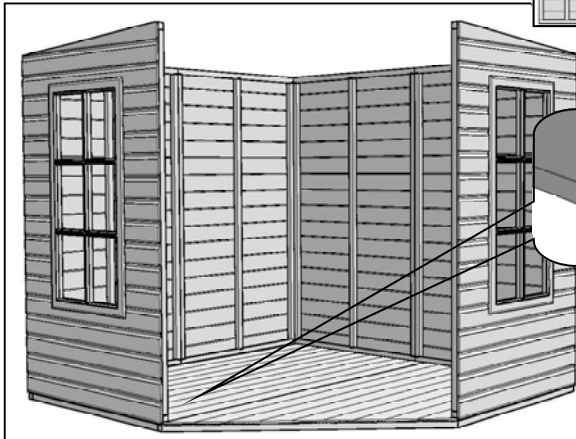

GB-IE Place one Angled door post 'A1386' at the edge of a window panel. The corner of the wider part of the post should be flush to the front of the window panel with its face flush with the floor. The sawn edge should rest against the window panel. The post should rest on the floor, but will overhang slightly. Drill/screw into position through the panel framework into the post using 3x 60 mm screws. Repeat at other side.

10

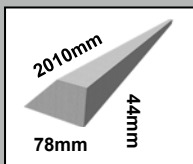

Angled door post (A1386) x02

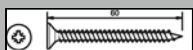

60mm Screw (A0035) x06

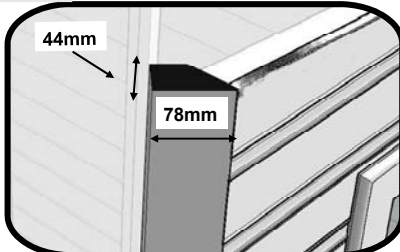
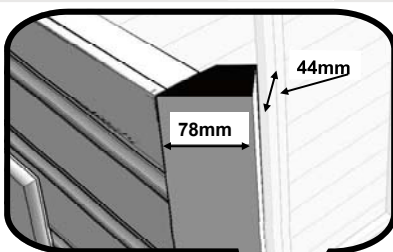

SEE PAGE 10

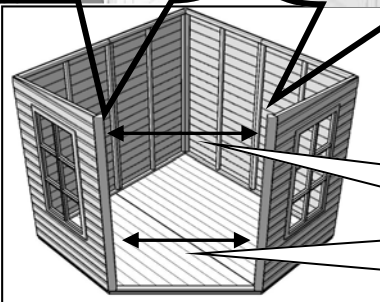

MUST BE 1360mm between posts

GB-IE Pre drill the door step "A1387" and the "A1318" gable before positioning. Fix the door step "A1387" on the floor between the posts from the previous step with 60mm screws. It should be central to the floor and it may be necessary to adjust the position wall panels to line up everything correctly. Fix the gable panel "A1318" level with the top of the posts with 60mm screws.

11

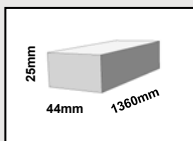
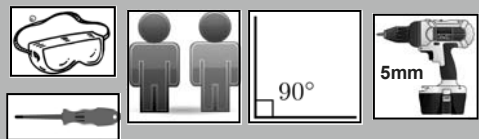

Door step (A1387)x01



Gable Panel (A1318)X01

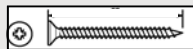

60mm Screw (A0035) x7

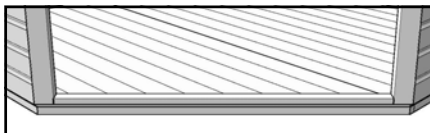
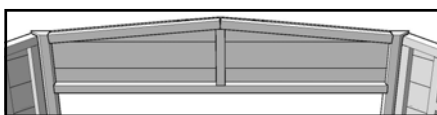
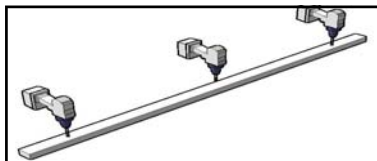
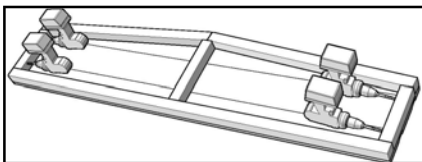

18

GB-IE Screw all the panels to the floor with 2 60mm screws each.

12

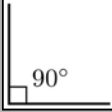

60mm Screw
(A0035)x12

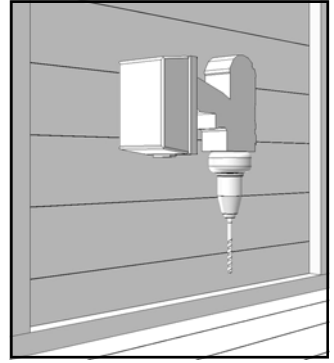

GB-IE Fix both doors leaving an even gap top and bottom with 1 x 25mm screw at first to the angled posts at each of the hinges
Adjust the door if necessary and fit the remaining screws

13

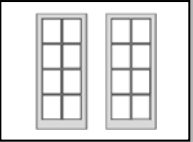

Doors
STEP1

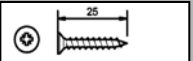
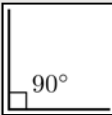

25mm Screw
(A0032)x30

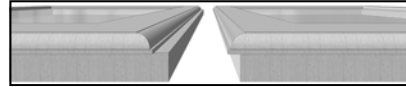
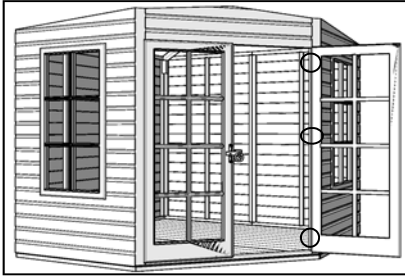

Secondary door
Bolted

Primary door
Opening first

View on bottom of doors

GB-IE Fix a bolt at the top and bottom of the secondary door
Mark where the bolt strikes the frame and drill an 8mm hole to take the bolt.

14

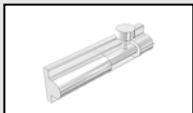

Door barrel bolt
(A0014)x02

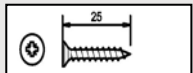

25mm Screw
(A0032)x12

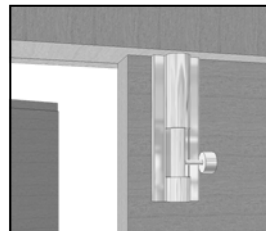
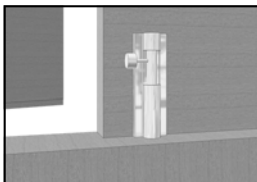

GB-IE

Fix a turn button to the top and bottom of the secondary door so they hold the primary door shut. This is to help with natural timber movement during different weather conditions. Failure to fit these turn buttons may result in the doors bowing.

15



Black Turn button (A1388)x02

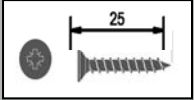

Black Screw (25mm)x2

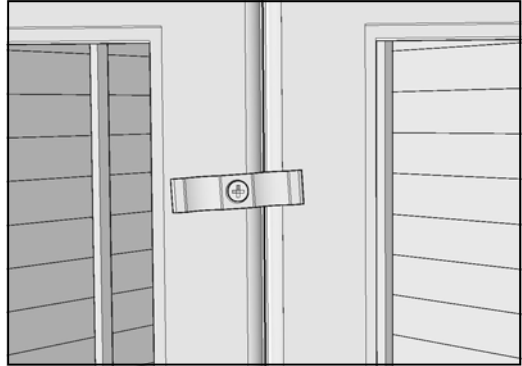

GB-IE

Position the Gate latch "A0015" on the outside over the **primary door**. Mark the screw holes as shown. Drill the middle hole only and fit the "SQUARE SHAFT" in the hole, locate the two ring handles onto the shaft and fix to the door. Align and fit the catch plate to the secondary door.

16



8mm



Gate latch (A0015) x01

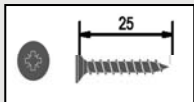

25mm Black screw (A0031)x10

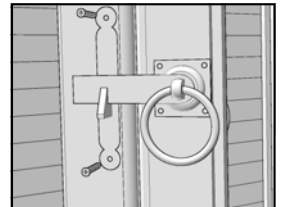
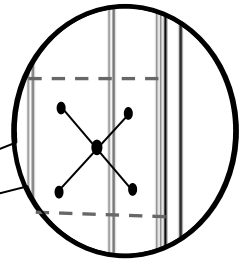
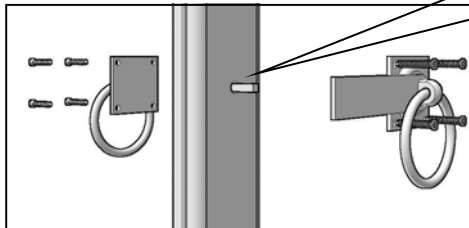

20

17



5mm

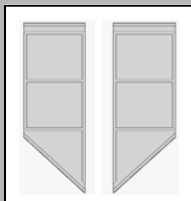
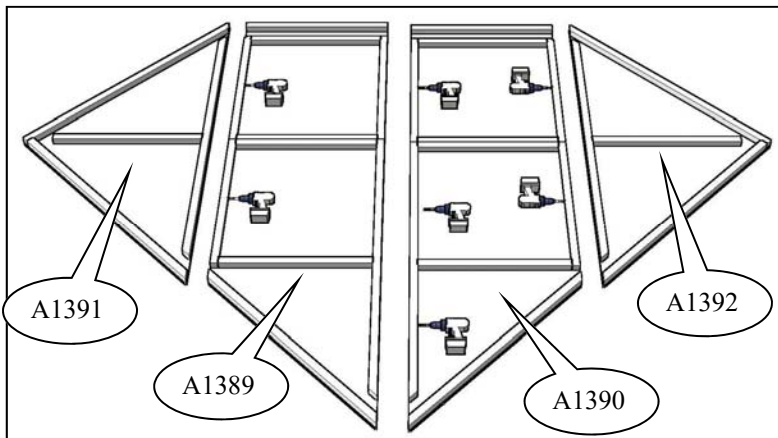

Front

Large roof panels
(A1389 A1390)Triangle roof Panel
(A1391 A1392)

GB-IE

Place the roof panels into position without fixing at this stage as it may be necessary to make adjustments to get the best fit

18

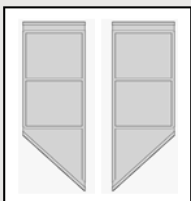
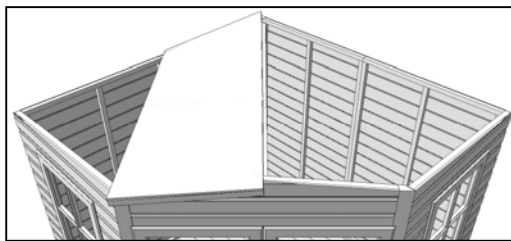
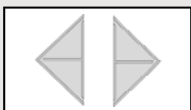
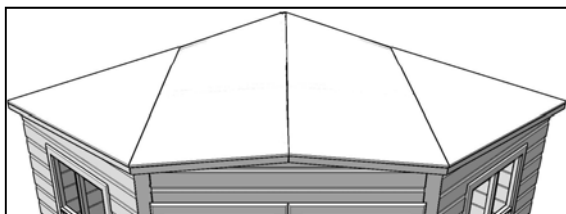
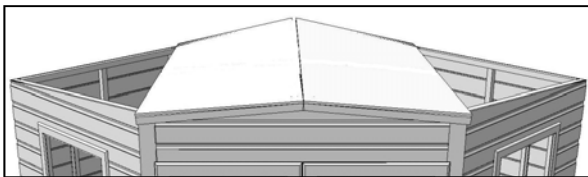
Large roof panels
(A1389 A1390)Triangle roof Panel
(A1391 A1392)

Carefully screw the panels together using the pre drilled holes and also use 4 screws to fix to the gable.
Nail through the roof panels into the top of the walls.

19

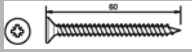
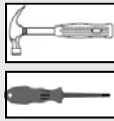

60mm Screw
(A0035) x 11

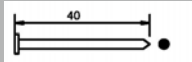

40mm Nail
(A0025) x 16

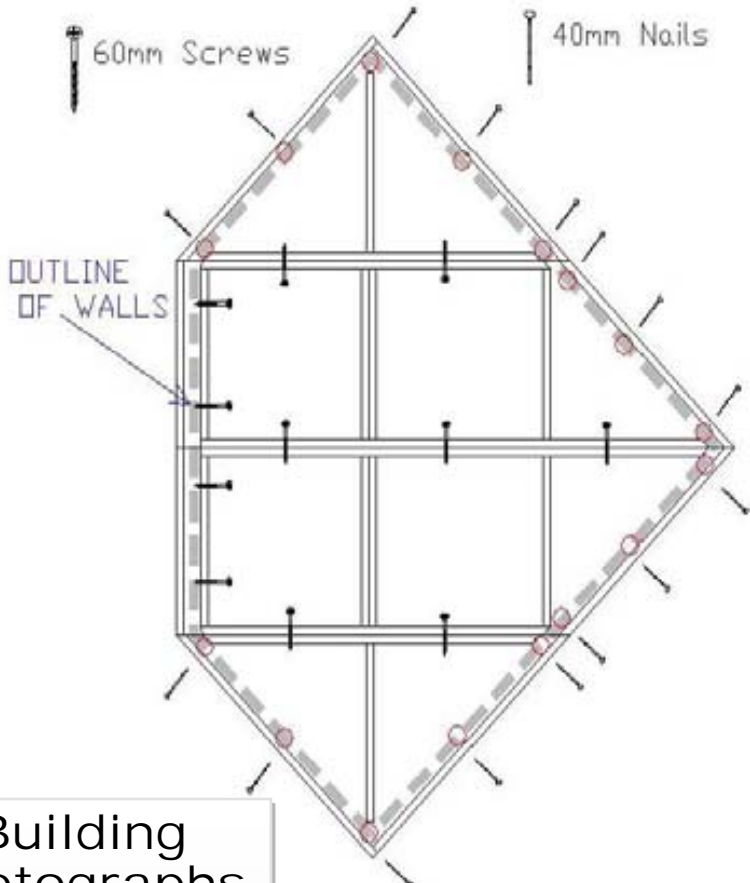

Building Photographs

It will be greatly appreciated if you could forward images of your completed

GB-IE

Position all the felt, starting from the back, without fixing first to ensure you have an even overlap. and at least 50mm to fold over the roof edgings and trim later .

Once you are happy with the positioning nail on top of the felt near the edge approximately 75mm apart.

Fold down the excess over the roof edgings fix as above and trim off the excess felt level with the bottom of the roof edging.

20

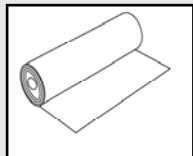

Felt strips
3.5m (A0054) x02
1.3m (A0126) x01

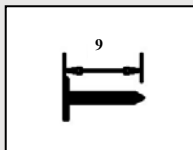

9mm Felt Nail
(A0266) x150



Reverse view

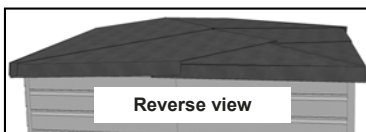

Reverse view

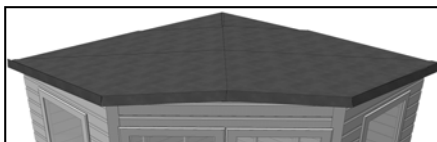
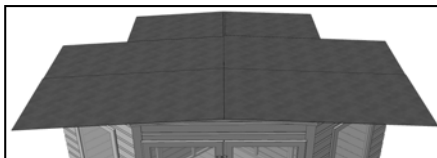
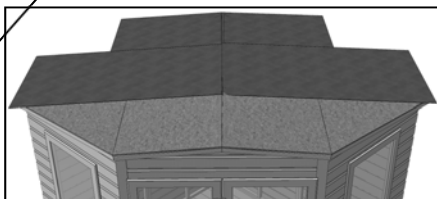
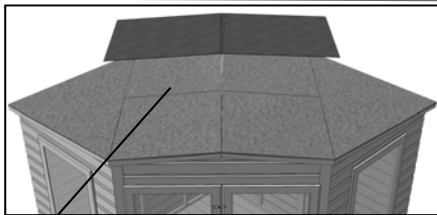

GB-IE

Fit cover strips at each corner with 4 nails each

21

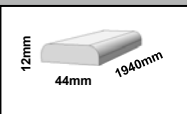

1190mm Cover strip
(A1393) x04

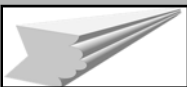

Cover strip
(A1394) x02

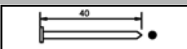

40mm Nail
(40mm) x24

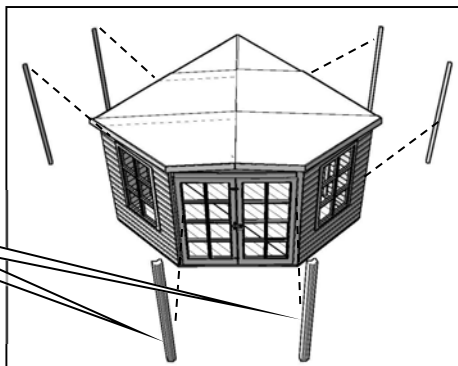

A1394

Drill and fix the fascias to the window panel first and then the gable with 3 nails each.
Drill and fix the diamond over the fascia join with 3 nails

22



1120mm
800mm

Fascia
1070mm(A1395) x02
800mm(A1396) x02



Diamond
(A0019) x01

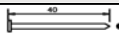

40mm Nail
(A0025) x15

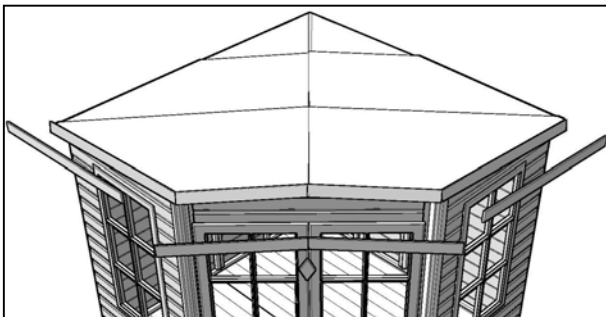

Remove the protective film from both sides of the glazing material before fitting.
Nail the beading at approximately 100mm spacing
Danger of cutting We advise you that a helper should hold the glass in position whilst you nail the beading. Wear gloves, suitable clothing and Shoes,



23

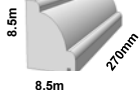

270mm Beading
(A0022)X56

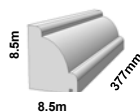

377mm Beading
(A0021)X56

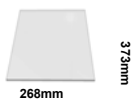

Glazing
(A0020) x56

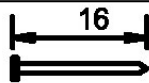

16mm Panel pin
(A0024) x224

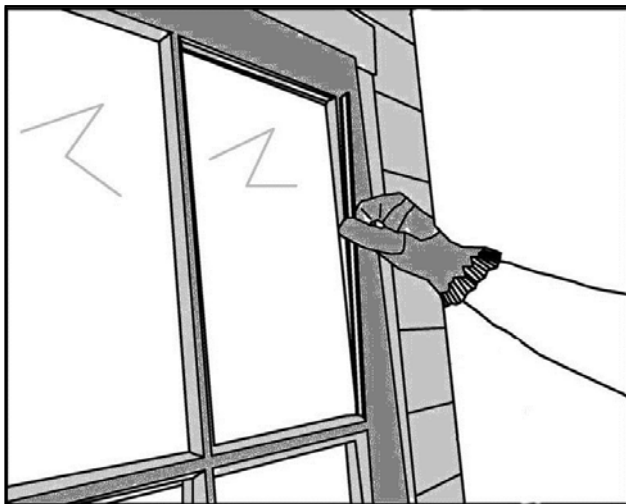

Glass
Danger of cutting