

## WARRANTY

We strive to offer high-quality products, and we also try our best to satisfy each and every customer that orders from us with product or service as needed. We provide 30 days warranty starting from the time you receive the item. Each customer must provide a record of their order such as the order number, or item receipt for any items that are out of the warranty period you may also still receive replacement parts by purchasing them with our company if they are available.

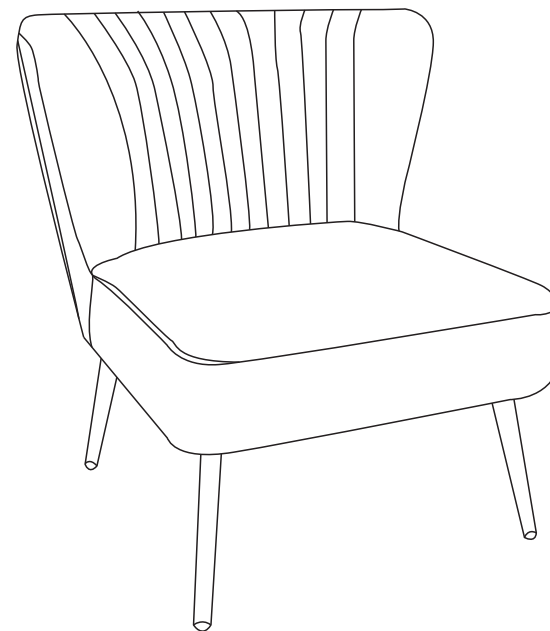

---

### NOTE:

---

This brochure contains IMPORTANT safety info. Please read and keep for future reference.

---

## MAINTAINANCE AND WARNING

- Keep furniture away from heat.
- Do not clean furniture with harsh cleansers or polish. Do not use detergents, Solvents, abrasives, spray packs or leather cleaner. Use non-color mild soap with warm water clean spills(Mix 1:10 soap to water)
- Do not place furniture under direct sunlight, material will possibly fade over time.
- Do not use on site dry Cleaning machine.
- Children should not climb or jump on the furniture.
- Do not write on furniture without a padded barrier to protect the surface.
- Not for commercial use, For residential use only.



Weight Limitation

**250LBS**

## PARTS LIST

**Ax1**

Seat

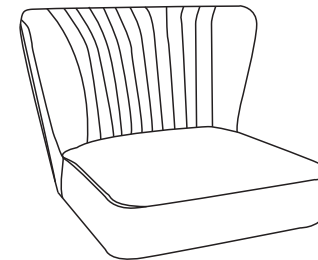

**Bx4**

Chair foot

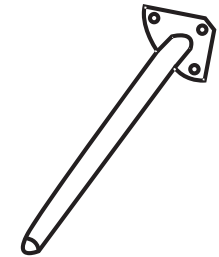

## HARDWARE LIST

Cx12  
M6\*20mm  
Screw

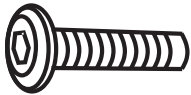

Dx1  
M6  
Spanner



## SPARE

Cx1  
M6\*20mm  
Screw

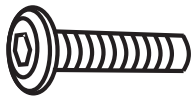

Hx1  
Gasket clasp



Be sure to check all packing material carefully for small parts, which may have come loose inside the carton during shipment.

## ASSEMBLY INSTRUCTIONS

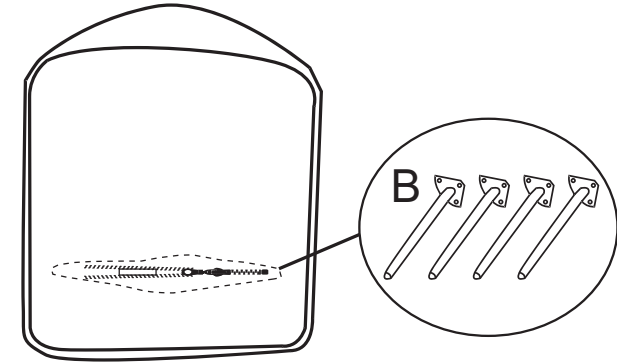

**STEP 1:** Open the zipper pocket under the seat and take the legs B out.

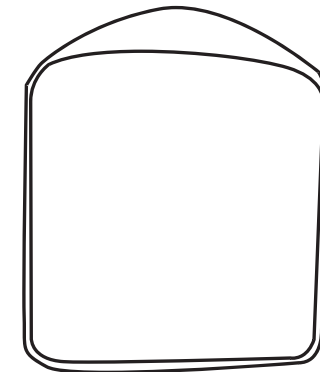

**STEP 2:** Place the Chair Back A on a clean padded surface.

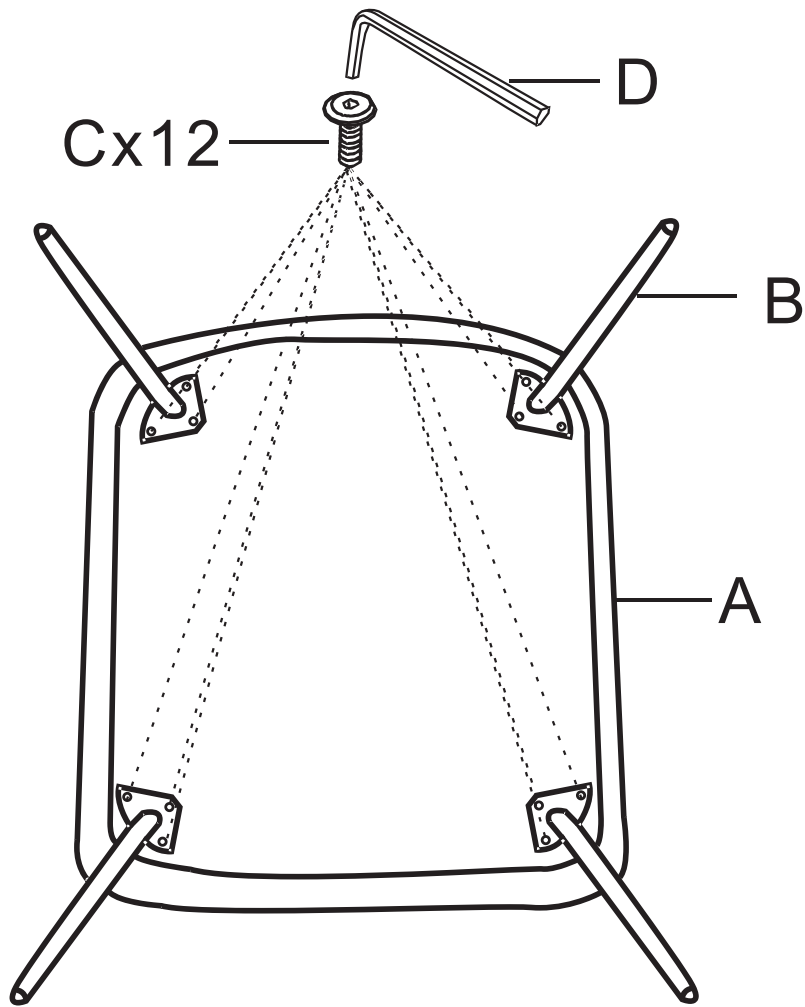

Place the chair seat/back assembly on clean padded surface.

**STEP 3** :Use bolt C, allen key D to connect the metal leg B to bottom of the seat cushion A, make sure all holes align, fasten all bolts to secure.

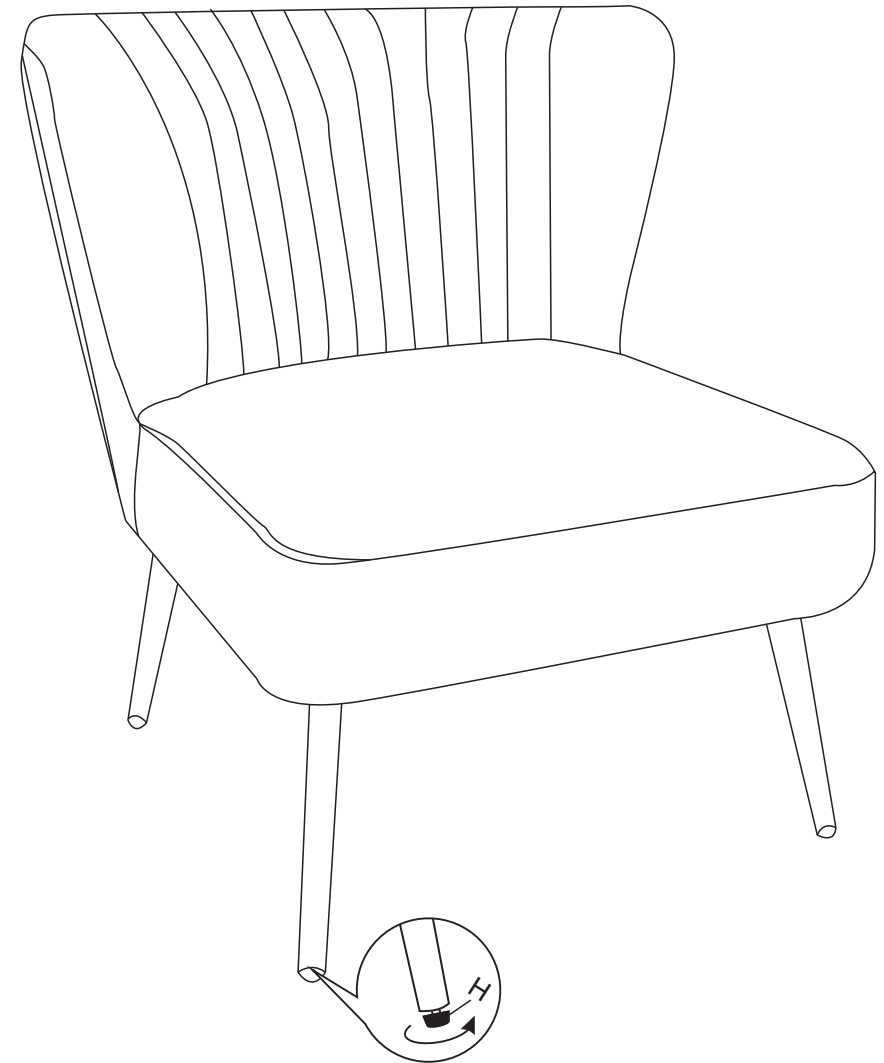

Adjust levelers under legs to set the seat level.

**STEP 4** :Assembly completed.