

WY-48495

—User Manual

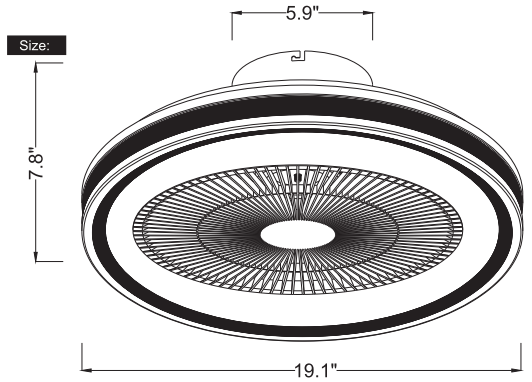

Installation instructions:

1

A
B

OFF

please confirm that the voltage matches the product, and turn off the power at the installation location to ensure safety.

2

Securely attach the mounting plate to the ceiling.

3

Connect the lamp driver input to the power source correctly and securely.

4

Rotate the lamp body to align the screws on the mounting plate with the holes on the leftmost hub.

5

Tighten the four screws on the mounting plate to ensure the fixture is securely installed.

6

C

ON

Turn on the power switch.

Precautions:

- Do not disassemble and modify the goods by yourself to avoid electric shock
- Do not use the product in high temperature, high humidity or outdoor places.
- Please clean the lamps with a dry soft cloth, and do not wipe the lamps with corrosive detergent.
- Do not use multiple electrical appliances in the same socket at the same time to avoid short circuit or fire.
- During cleaning and maintenance, the operating instructions and precautions should be followed to avoid the danger of electricity.
- Pay attention to the condition of ceiling fan lights at any time. If there is any malfunction, stop using them immediately and contact the maintenance station designated by the manufacturer for maintenance. Do not replace parts or disassemble and repair them by yourself and pay attention to regular maintenance to ensure safe use.

Emergency treatment method:

- Please immediately turn off the power supply and stop using it in the following situations:
- When the main lamp is wet or comes into contact with liquid/rain
 - When the main lamp falls and is damaged.
 - Smoke, sparks, etc. occur in the ontology lamps.
 - LED light source flashes abnormally or is damaged.

Packaging accessories:

- Fan lamp body*1
- Instructions (assembly instructions)
- Remote control
- Parts package

Warning:

- This appliance is not intended to be used by users (including children) with insufficient physiology, awareness mental ability, experience or knowledge, unless it is safely used under the supervision or guidance of those responsible for the safety of women and children, electrical appliances.
- This appliance should be installed with fan lights according to the instructions, and adhesive is not allowed.
- When installing electrical appliances, the fan blades should be more than 2.3m above the ground (for electric fans installed at high places).

1.Tuya WiFi Fan With Light App Instructions

1.1. Download and install App

Scan the QR code below or search SmartLife to download SmartLife



1.2.Register/Login/Forget password

Register:Register your account to the following tips before using at the first time.If you have an account,please enter the password to login directly.

Login:Input the correct account number and password to login.

Forgert your password:You can enter the login page to retrieve your password.

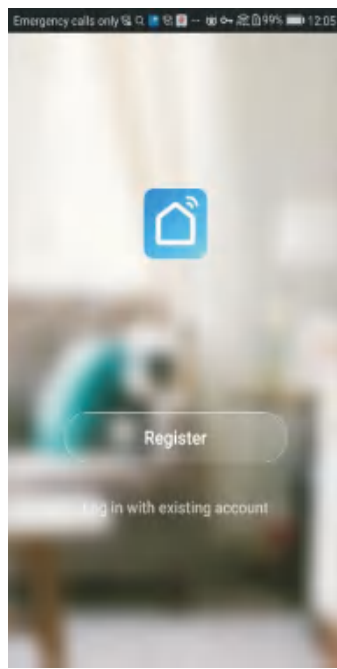
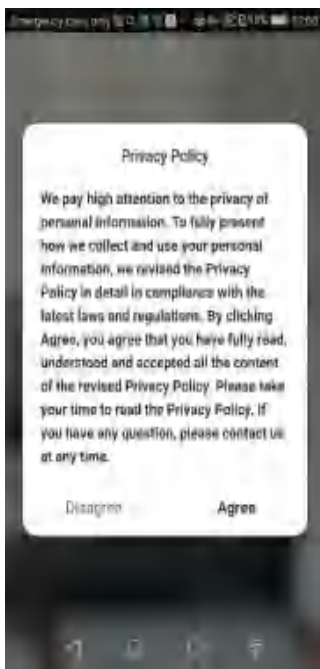
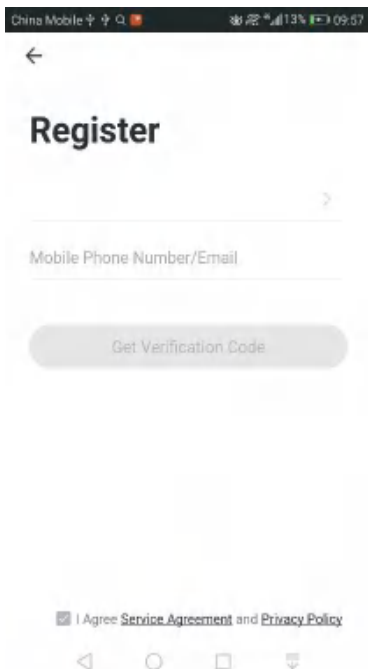

1.3. Device configuration and control

1 Open your Phone Bluetooth, then connect the device to the power supply and confirm that the device can work normally (the light turns on slowly);

2 Continuous ON-OFF-ON-OFF-ON Power on and off three times (power on for 2~3 seconds, power off for 5~10 seconds) to make the device enter the distribution network mode, at this time the main light source will remind you to breathe;

3 Open the Smart Life App, click Add Device in the upper right corner, and wait for the App to automatically search for peripheral devices;

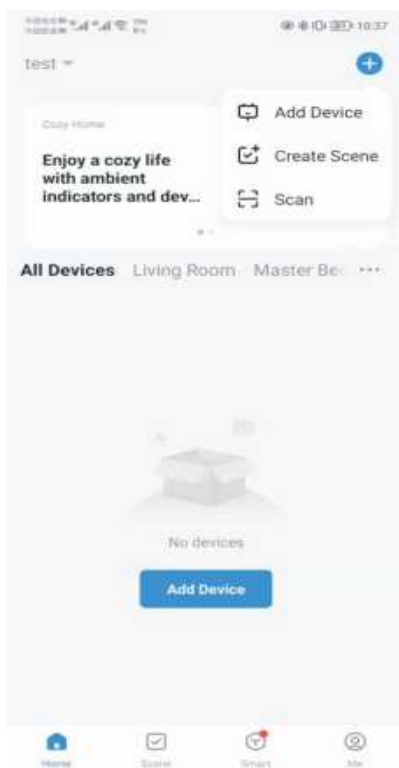

4 After the App scans the device, click Add to bind the device, then enter your router password:

Note: Only support 2.4GHz WiFi network

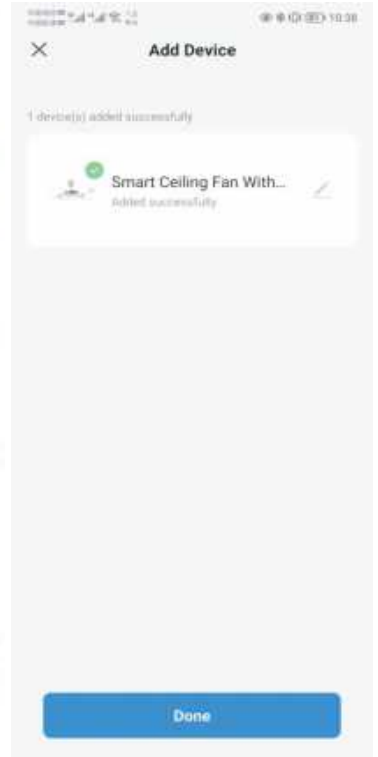
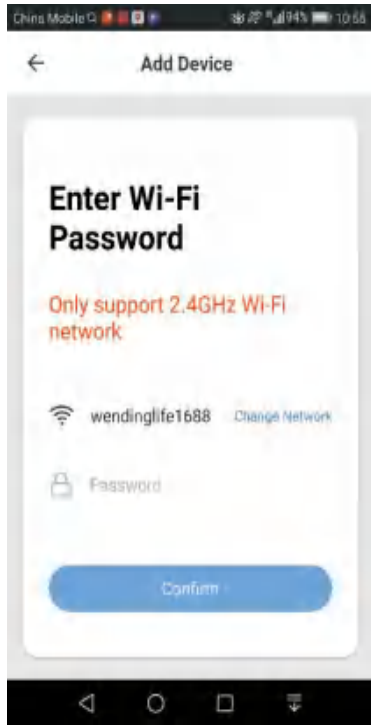

5 Click Done to enter the device control page



2. Remote Control Instructions

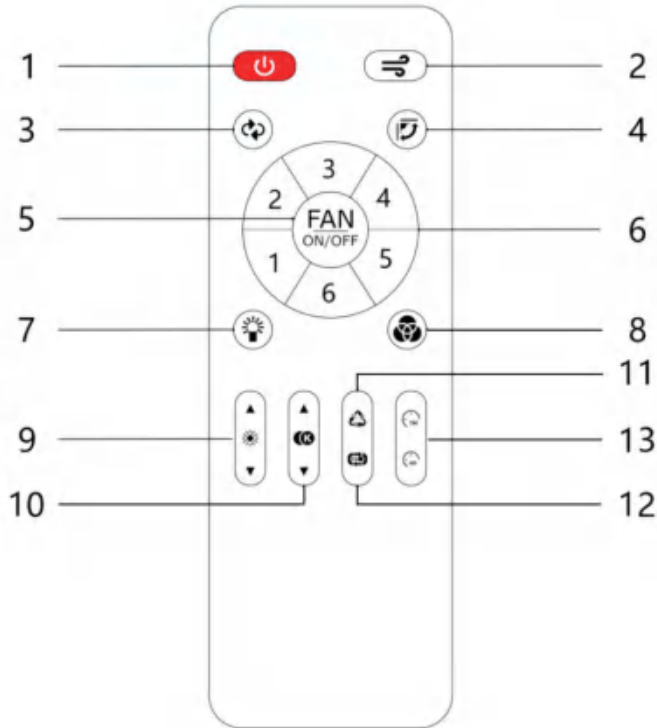

2.1. Pair code

Connect the device to the power supply and confirm that the device can work normally (the light turns on slowly);

Turn off the power of the device for 5~10 seconds and then turn on the power again;

Long press Button 1 until the device flashes 3 times quickly, then let go;

The code pairing of the remote control is successful. At this time, you can press the button to control the device.

2.2. Clear code

Connect the device to the power supply and confirm that the device can work normally (the light turns on slowly);

Turn off the power of the device for 5~10 seconds and then turn on the power again;

Long press Button 1 until the device flashes 3 times quickly, then let go;

The remote control is successfully cleared. At this time, the remote control can no longer control the device and needs to be re-paired before it can be used.

2.3. Control

Button 1: All off, short press to turn off the main light & color light & fan;

Button 2: Fan mode, short press to switch between natural and comfortable wind;

Button 3: Fan direction, short press to switch between forward and reverse;

Button 4: fan rocker switch, only some models support this function;

Button 5: Fan switch, short press to turn on/off the fan, long press the button for 5 seconds to enable the device to enter the App distribution network mode;

Button 6: Fan speed, short press to adjust the speed of 6 levels

Button 7: White light switch, short press to turn on/off the white light;

Button 8: Color light switch, short press to turn on/off color light;

Button 9: Brightness addition and subtraction, short press to adjust the brightness of 10 levels, and long press to adjust the brightness steplessly;

Button 10: Addition and subtraction of temperature, short press to adjust the 10-level temperature, long press to adjust the temperature steplessly;

Button 11: Color static cycle switching (red, yellow, green, blue, purple, white);

Button 12: Color dynamic cycle switching;

Button 13: 1 hour/4 hours countdown timer off, fan & white light & color light all off at the same time;

3. Works with Amazon Alexa

3.1. Configure Amazon Echo and enable Smart Life skill

Download the Alexa mobile App:

Log in to the App Store with Apple ID registered in the United States, and search and download Amazon Alexa for iOS.

Go to Google Play, and search and download Amazon Alexa for Android.

This section describes how to configure Amazon Echo in the Alexa mobile app. The configuration procedure is similar for the Alexa web application.

3.2. Configure Amazon Echo in Alexa mobile app

Prerequisites:

The Echo is powered on.

The Echo is connected to a Wi-Fi network over which Amazon services are accessible.

Procedure:

1. Open the Amazon Alexa app.
2. Enter the Amazon account and password, and tap SIGN IN.

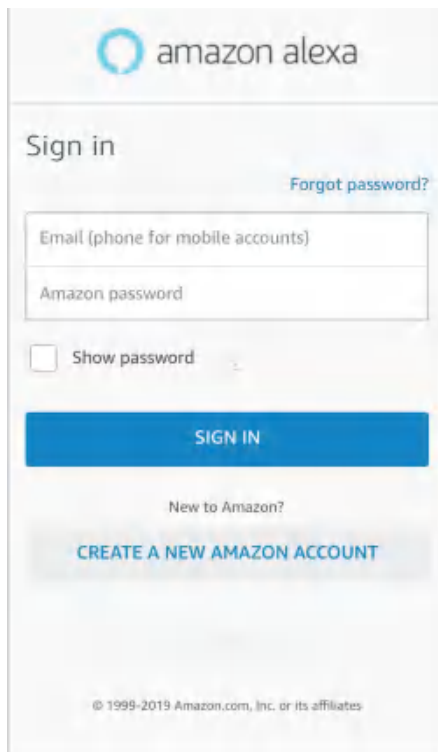

The screenshot shows the sign-in interface of the Amazon Alexa mobile app. At the top, the Amazon Alexa logo is displayed. Below it, the text "Sign in" is shown, with a link for "Forgot password?". There are two input fields: "Email (phone for mobile accounts)" and "Amazon password". A checkbox labeled "Show password" is located below the password field. A prominent blue "SIGN IN" button is centered on the screen. Below the button, there is a link for "New to Amazon?" and a button labeled "CREATE A NEW AMAZON ACCOUNT". At the bottom, the copyright notice "© 1999-2019 Amazon.com, Inc. or its affiliates" is visible.

3. After successful login, in the bottom right corner of the **Home** page, tap **More > Add a Device**, and on the **SETUP** page that appears, select the **Amazon Echo** brand.

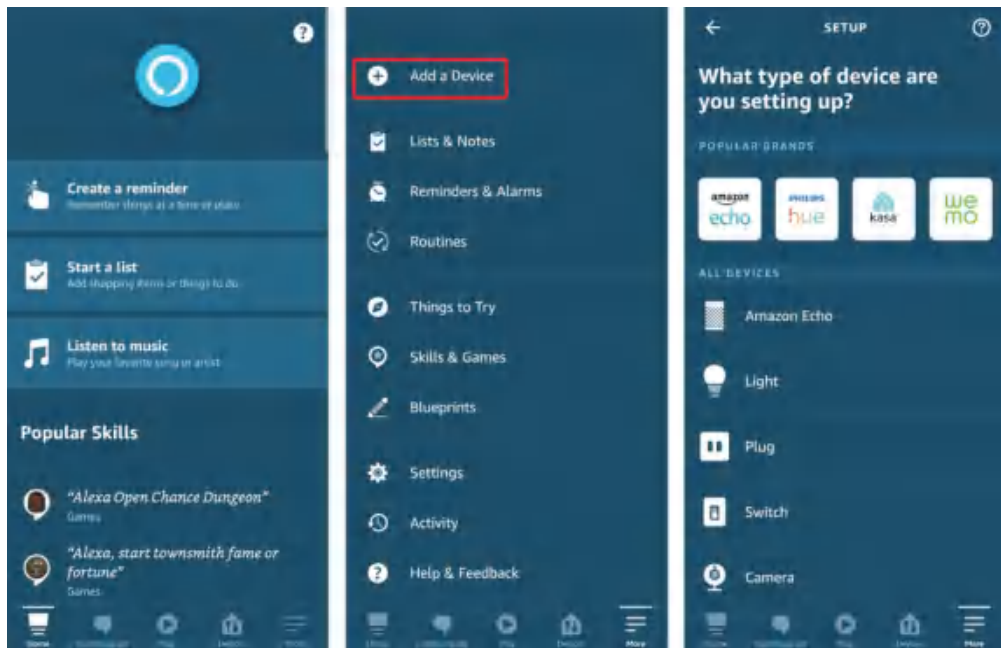

4. Select your Echo device type and tap **CONTINUE** to configureEcho.

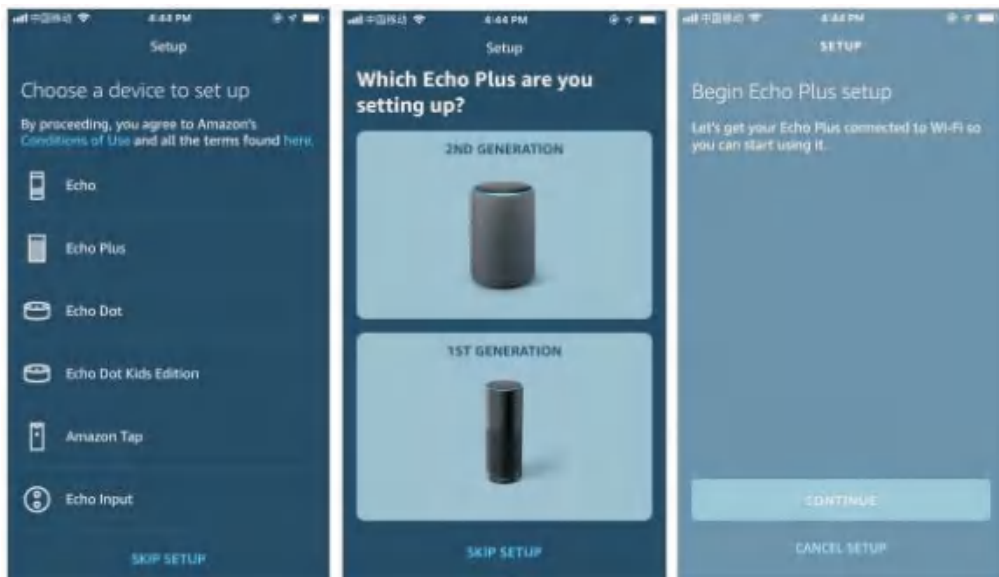

5. When the page **Wait for the orange light** appears, press and hold the action button until the light ring turns orange. Tap **CONTINUE** to connect the mobile phone to the hotspot of the Echo, and tap **CONTINUE**.

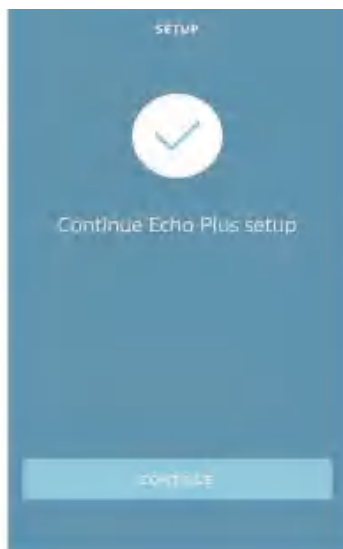
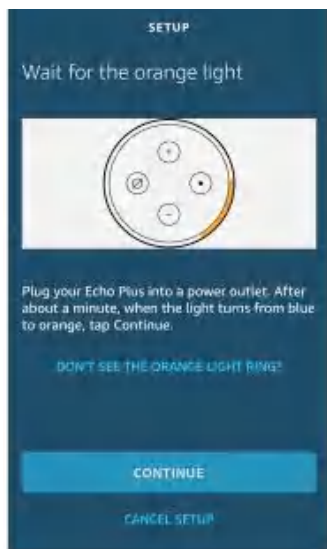

6. Select a **Wi-Fi** network to which the **Echo** will be connected. Enter the **Wi-Fi** password and tap **CONNECT**. It takes several minutes for the **Echo** to successfully connect to the **Wi-Fi network**.

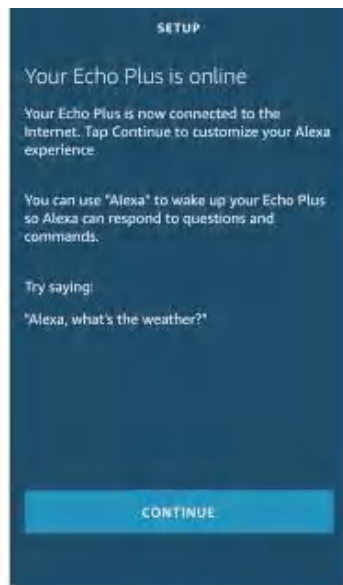

7. Then, tap **CONTINUE**. A video walkthrough appears to help get you started. At the end of the video, tap **NEXT** to navigate to the Home page of **Alexa**. Now, the Echo is configured.

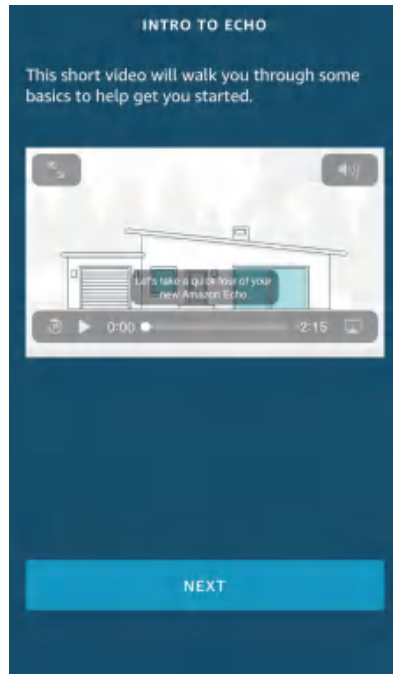

3.3. Bind Smart Life app with Alexa

Method 1: Use Smart Life app to start binding

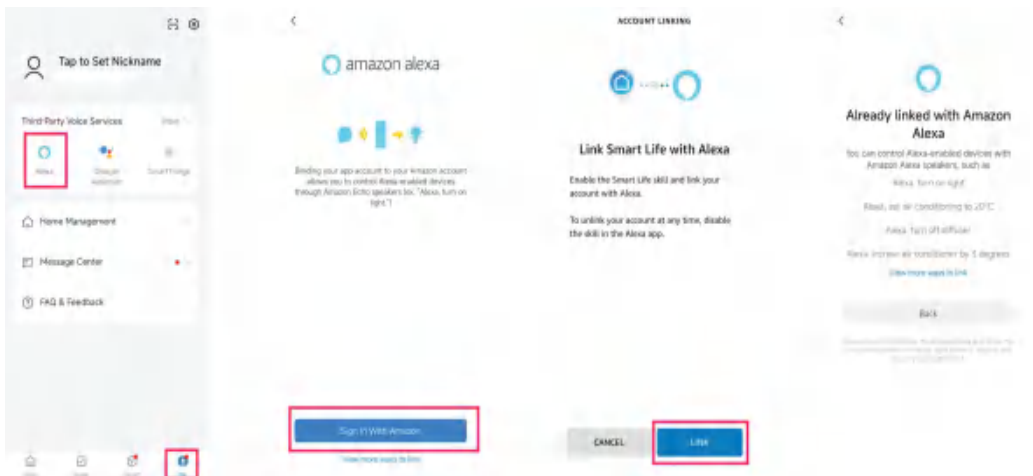

Method 2: Use Alexa app to start binding

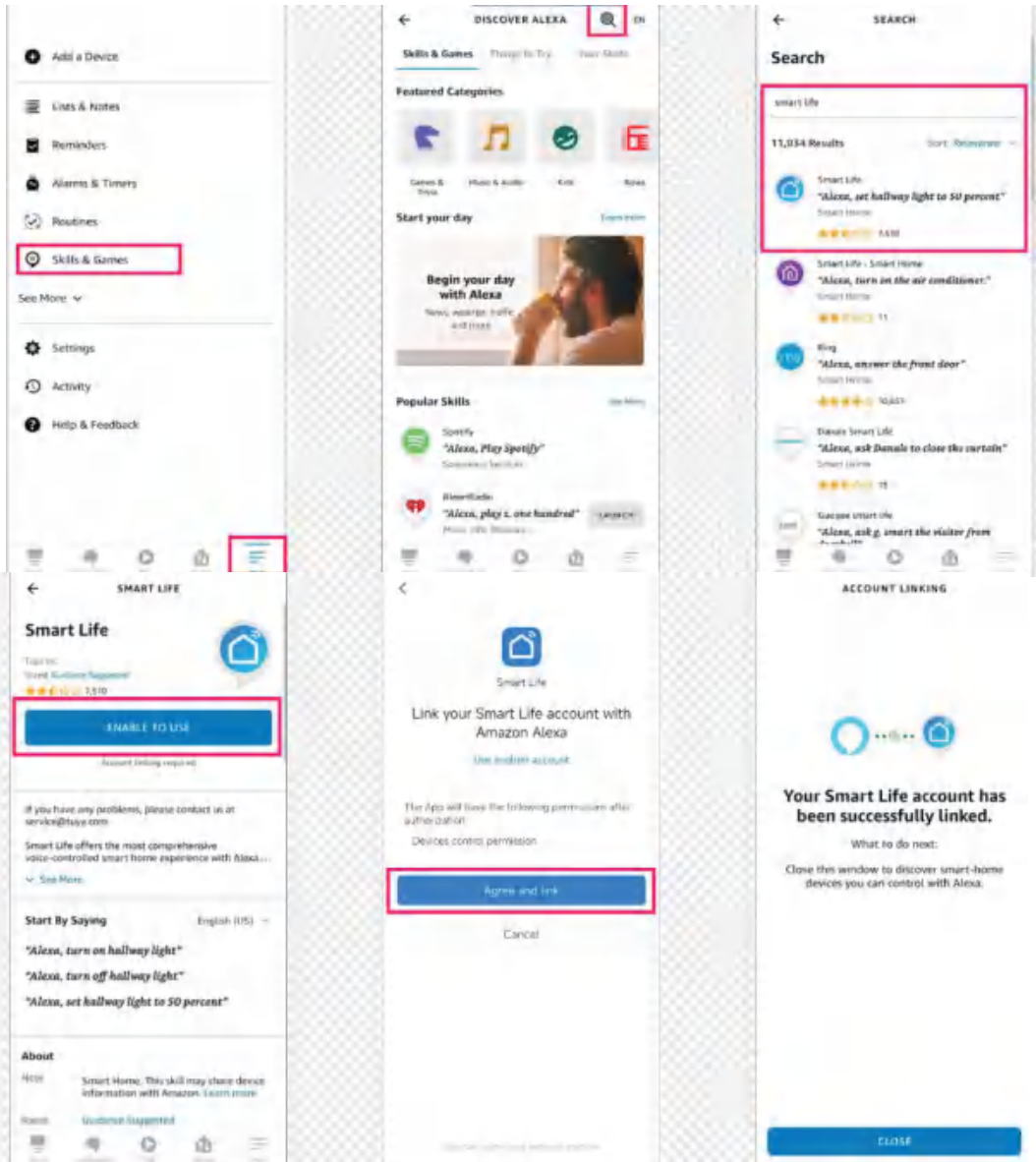

3.4. Use Echo to control smart device

The Echo needs to discover a device before it can control the device. The device discovery page automatically appears after the Smart Life skill is bound. Tap **DISCOVER DEVICES** to search for devices. You can also say to the Echo: “Alexa, discover devices.” Then, the Echo starts searching for smart devices that are paired with the Smart Life app. The Echo reports the search result about 20 seconds later and the Alexa app displays the discovered devices in a list.

NOTE:

You can use the DISCOVER DEVICES feature to discover only the devices that have been added to the Smart Life app. Other unpaired devices cannot be discovered and added to the Echo.

If a device is renamed in the Smart Life app, the Echo must discover the device again.

Otherwise, it cannot control the device.

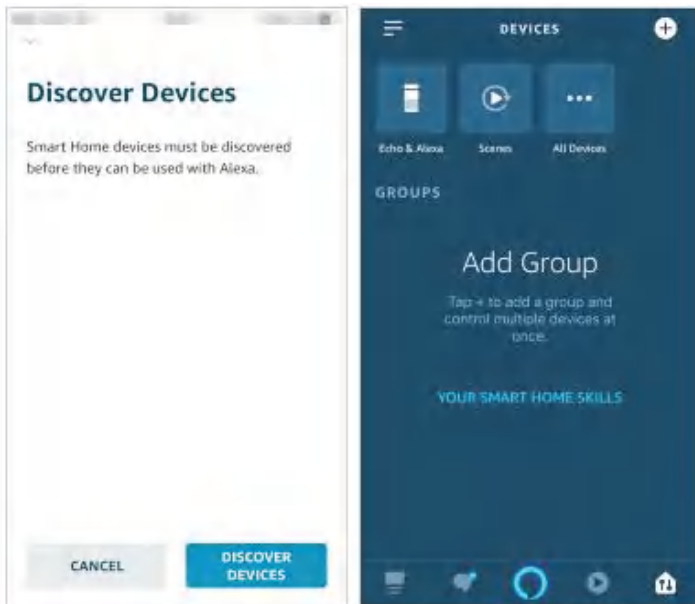

3.5. Use voice commands to control device

Now, you can use the following commands to control a device, such as a bedroom light:

Alexa, turn on/off Fan light. (turn on or off the device) percent. (set the brightness)

Alexa, brighten/dim Fan light. (increase or decrease the brightness)

Alexa, set Fan light to red /green/blue. (set the color)

Alexa, set Fan light to warm white. (set the color temperature)

Alexa, turn on/off Fan. (turn on/off the fan)

4. Works with Amazon Google Home

4.1. Download Google Home app

Log in to the App Store with Apple ID registered in the United States, and search and download Google Home for iOS.

Go to Google Play, and search and download Google Home for Android.

4.2. Link account of Smart Life app

Method 1: Use Google Home app to start linking

1. Open the Google Home app and tap + in the top left corner of the homepage.
2. Select **Set up device > Works with Google**.
3. Tap the Search icon in the top right corner of the page, and search by Smart Life app name.
4. Tap the searched result and then **Continue**. The Google Home app will wake up the Smart Life app. Tap **Agree and link** and wait to the end of loading. This way, the Smart Life app is linked with the Google Assistant.

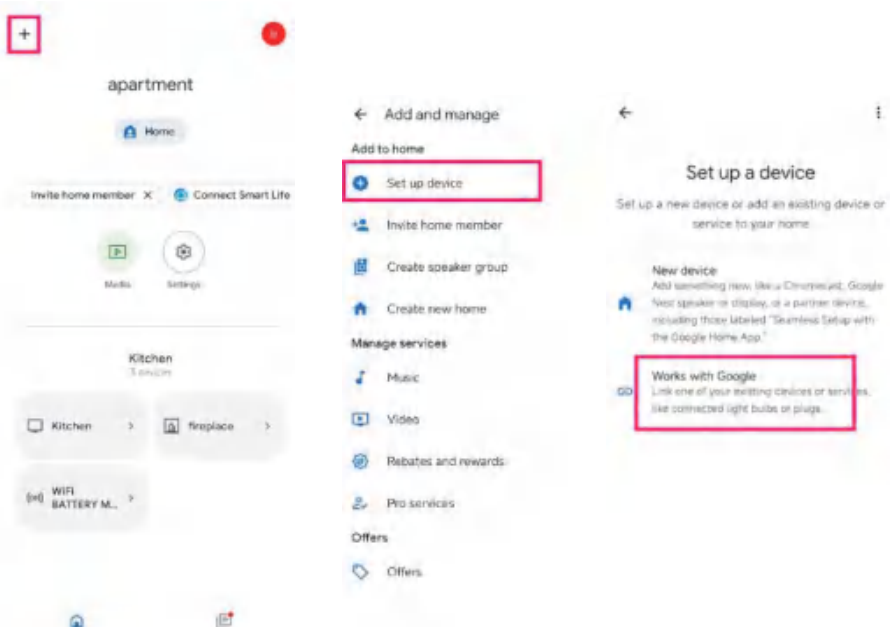

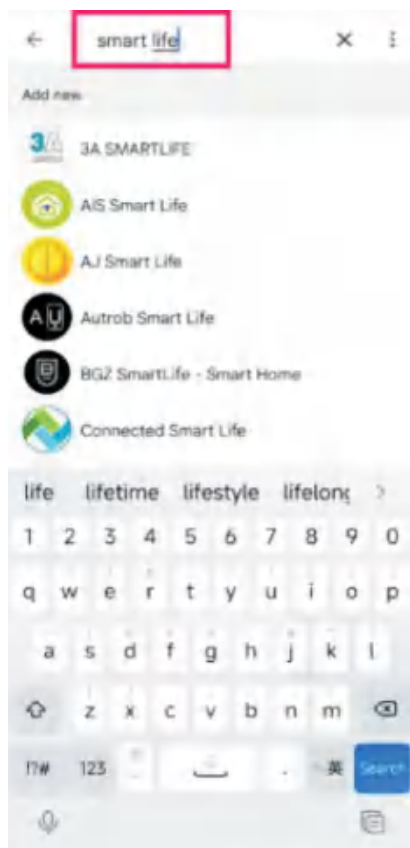
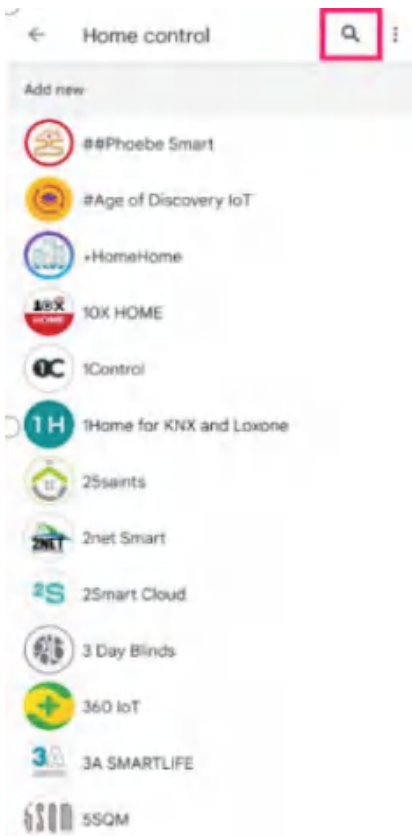



Link an account to control Smart Life
on any device



This link will be available on devices or services
where you're signed in to your Google Account.
You can change this link in your Google Account.

Cancel

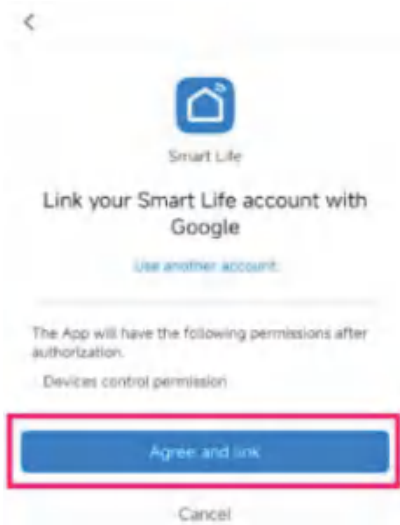
Continue



Method 2: Use Smart Life app to start linking

If the mobile phone has the Google Home app installed, open the Smart Life app and tap **Me** on the tab bar.

In the **Third-Party Voice Services** section, select **Google Assistant > Link with Google Assistant** to wake up the Google Home app.

Tap **Continue** to return to the Smart Life app.

Tap **Agree and link** to access the Google Home app. This way, the Smart Life app is linked with the Google Assistant.

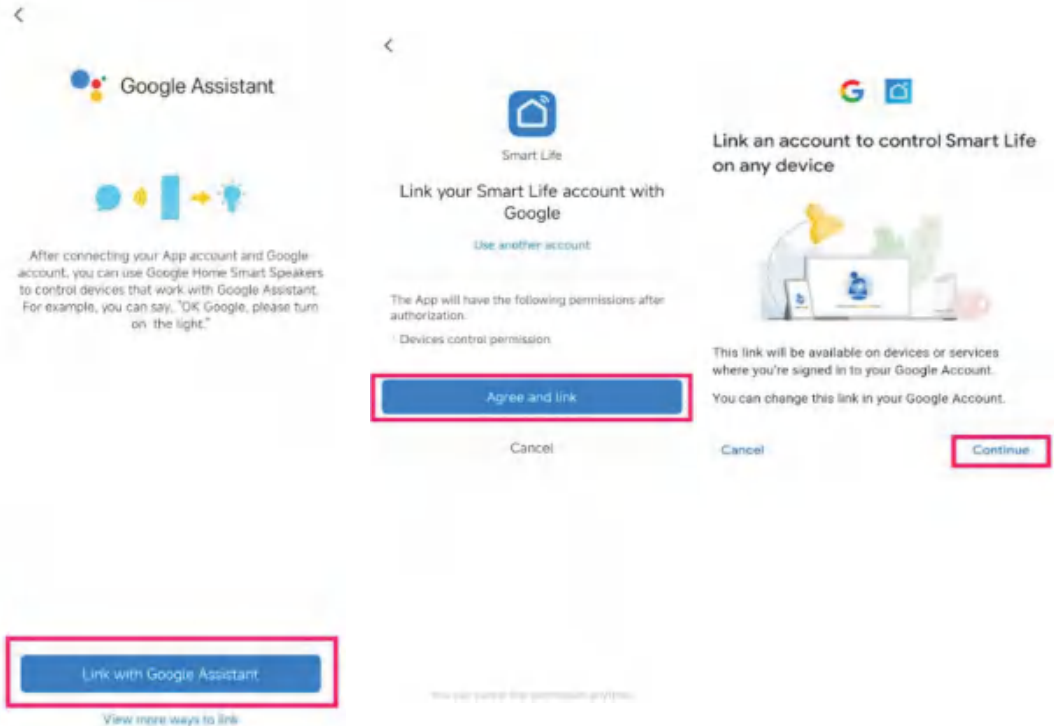

4.3. Use Google Home to control smart devices

Now, users can speak the following voice commands and control your smart devices from Google Home. For example, for a bedroom light, Google Home currently supports the following commands in English only:

Ok Google, turn on Fan light.

Ok Google, turn off Fan light.

Ok Google, set Fan light to 50 percent. (set the brightness of the light)

Ok Google, brighten Fan light.

Ok Google, turn on/off Fan. (turn on/off Fan)