

Owner's Manual & Assembly Guide

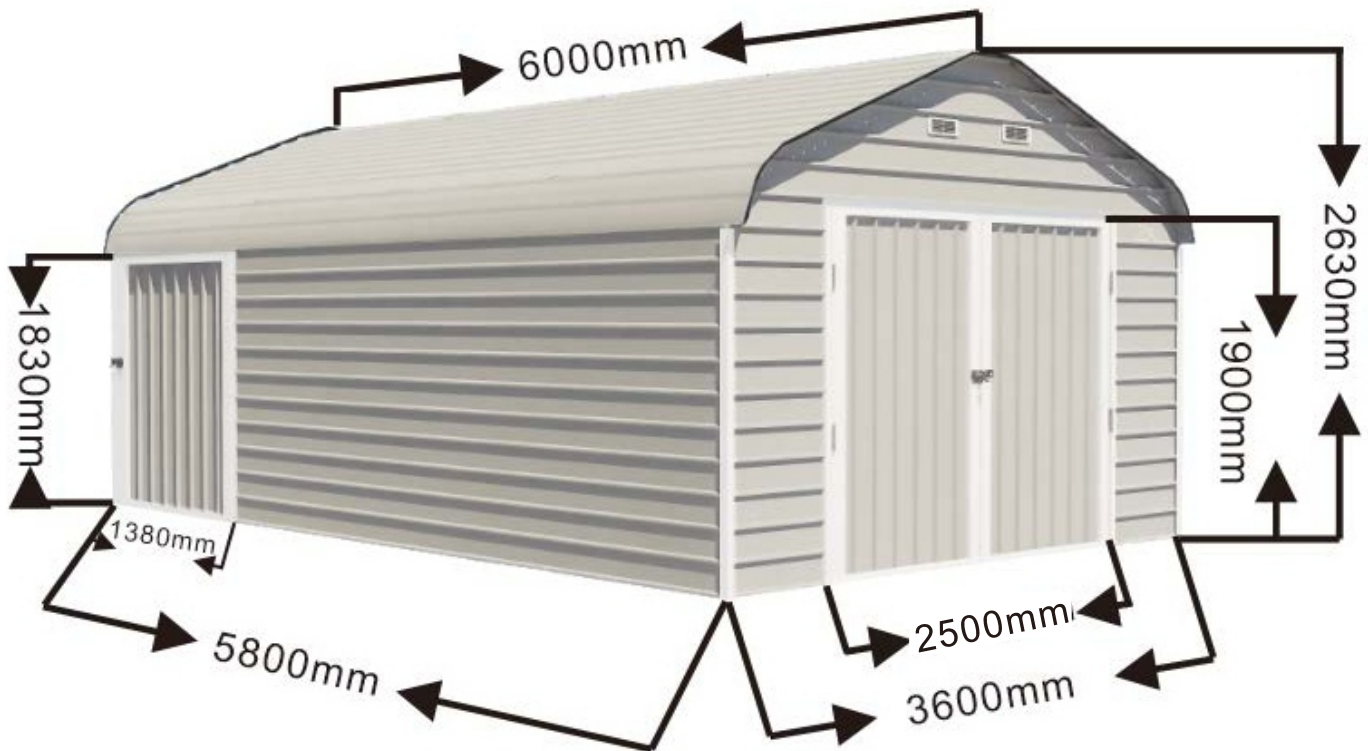

12X20 FT storage shed



SAFETY & MAINTENANCE

Safety precautions MUST be followed at all times throughout the construction of your building!

sharp edges

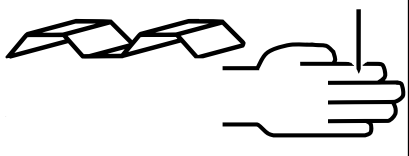

Care must be taken when handling various pieces of your building since many contain sharp edges. Please wear work gloves, eye protection and long sleeves when assembling or performing any maintenance on your building.

don't focus weight on roof

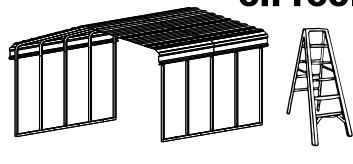

NEVER concentrate your weight on the roof of the building. When using a step ladder make sure that it is fully open and on even ground before climbing on it.

always practice proper tool safety

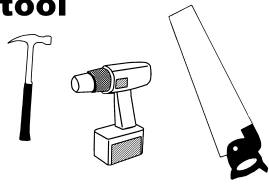

Practice caution with the tools being used in the assembly of this building. Be especially familiar with the operation of all power tools.

no children or pets at worksite



Keep children and pets away from the worksite during construction and until the building is completely assembled. This will help avoid distractions and any accidents which may occur.

beware of wind



Do NOT attempt to assemble your building on a windy day. The large panels can catch the wind like a "sail", causing them to be whipped around making construction difficult and unsafe.

Do NOT attempt to assemble your building before double checking that you have all the parts indicated on the parts list as well as all hardware. Any building left partially assembled may be seriously damaged by even light winds.

IMPORTANT NOTE ON ANCHORING

- Your building MUST be anchored to prevent wind damage. See anchoring page for more info.
- You must also have a temporary anchoring system in place in case you need to take a break from assembly.

Exterior Care:

For a long lasting finish, clean and wax the exterior surface. We recommend washing with a mild soap solution. DO NOT use power washing to clean your shed. Using a spray automotive type wax periodically on the exterior is highly recommended if you are in a high humidity or coastal climate region.

Combustibles and corrosives must be stored in air tight containers designed for chemical and/or combustible storage. Corrosive chemicals such as fertilizers, pesticides and herbicides should be cleaned off the interior and exterior surfaces immediately. Rust caused by chemical damage is not covered by the warranty.

Rust protection precautions may help to stop rust from developing, or stop it quickly as soon as it appears.

- Avoid nicking or scraping the coating surface, inside and out.
- Keep roof and base perimeter free of debris and leaves which may accumulate and retain moisture. These can do double damage since they give off acid as they decay.
- Touch up scrapes or nicks and any area of visible rust as soon as possible. Make sure the surface is free of moisture, oils, dirt or grime and then apply an even film of high quality touch-up paint.
- Various paint manufacturers provide products for rust treatment and coverage. If surface rust does appear on your shed we recommend treating those areas as soon as possible, following the paint supplier of your choice instructions.
- Our customer service department can provide the paint tinting formula for matching the color of your shed. We also have touch-up paint available for repairing small nicks and scratches.

Roof: Keep the roof clear of leaves and snow. Heavy amounts of snow on the roof can damage the building making it unsafe to enter.

Fasteners: Regularly check fasteners and retighten as necessary.

General: Wash off inked part numbers on coated panels with soap and water.

Please note, Manufacturer cannot be held responsible for any consequences due to buildings that are not installed per these instructions, or for damage due to weather conditions or acts of God.

Keep these assembly instructions and owner's manual for future reference.

MESURES ET ENTRETIEN

Les mesures de précaution doivent **IMPÉRATIVEMENT** être respectées en permanence tout au long du montage de l'abri.

bords coupants

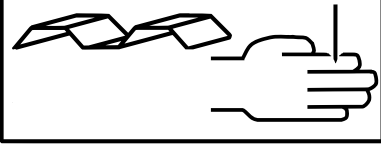

Faire preuve de précaution pour manipuler les différentes pièces de l'abri car elles présentent de nombreux bords coupants. Veiller à porter des gants de travail, une protection oculaire et des manches longues pour l'assembler ou effectuer toute opération d'entretien sur l'abri.

ne jamais concentrer de poids sur le toit

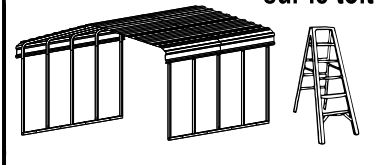

NE JAMAIS concentrer son propre poids sur le toit de l'abri. Si un escabeau est utilisé, vérifier qu'il est entièrement ouvert et sur un sol de niveau avant d'y monter.

toujours veiller à la sécurité de l'outillage

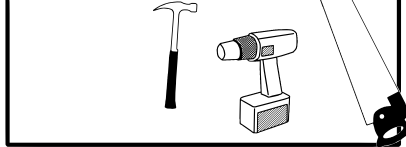

Utiliser avec précaution l'outillage nécessaire pour l'assemblage de l'abri. En particulier, veiller à bien savoir comment fonctionnent tous les outils électriques.

pas d'enfants ni d'animaux sur le chantier



Tenir les enfants et les animaux domestiques à l'écart du chantier durant la construction et jusqu'à ce que l'abri soit complètement assemblé. Cela évite les distractions et les accidents potentiels.

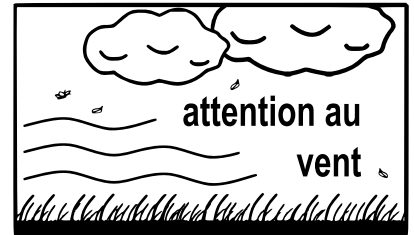

Ne PAS tenter d'assembler l'abri en présence de vent. Les grands panneaux peuvent se comporter comme une voile et « battre » au vent, rendant la construction difficile et dangereuse.

Ne PAS tenter d'assembler l'abri avant d'avoir vérifié la présence de toutes les pièces figurant dans la liste des pièces ainsi que de toute la visserie. Tout abri laissé partiellement assemblé peut être gravement endommagé par des vents même légers.

NOTE IMPORTANTE SUR L'ANCRAGE

- L'abri doit **IMPÉRATIVEMENT** être ancré pour éviter les dommages par le vent. Voir les informations à la page Options d'ancrage.
- Prévoir également un système d'ancrage provisoire s'il est nécessaire d'effectuer une pause durant l'assemblage.

Exterior Care:

Pour assurer la durabilité de la finition, nettoyer et cirer la surface extérieure. Il est conseillé de la laver avec une solution de savon doux. NE PAS utiliser de jet sous haute pression pour nettoyer l'abri. Dans les climats très humides ou côtiers, il est fortement conseillé de vaporiser une cire de type automobile sur l'extérieur à intervalles réguliers.

Les matières combustibles et corrosives doivent être entreposées dans des contenants étanches à l'air conçus pour l'entreposage de produits chimique et/ou combustibles. Les produits chimiques corrosifs tels que les engrais, pesticides et herbicides doivent immédiatement être nettoyés des surfaces intérieures et extérieures. La rouille causée par des produits chimiques n'est pas couverte par la garantie.

Des mesures de protection contre la rouille peuvent empêcher l'apparition de la rouille ou l'arrêter rapidement lorsqu'elle apparaît.

- Éviter d'entailler ou de rayer le revêtement de surface, à l'intérieur comme à l'extérieur.
- Nettoyer le toit et le pourtour de la base de tous débris et feuilles mortes susceptibles de s'accumuler et de retenir l'humidité. Le dommage peut être double, car la décomposition de ces déchets dégage de l'acide.
- Retoucher les entailles et égratignures et toute surface de rouille visible dès que possible. S'assurer que la surface ne présente pas d'humidité, d'huile, de saleté ou de crasse puis appliquer une couche de peinture de retouche de haute qualité.
- Divers fabricants de peinture proposent des produits de traitement et de couverture de la rouille. Si de la rouille apparaît sur la surface de l'abri, il est conseillé de la traiter dès que possible, conformément aux instructions fournies avec la peinture choisie.
- Notre service à la clientèle peut fournir la formule de mise à la teinte de la peinture correspondant à la couleur de l'abri. Nous proposons également des peintures de retouche pour réparer les petites entailles et égratignures.

Toit: Nettoyer toute accumulation de neige et de feuilles sur le toit. Les lourdes quantités de neige sur le toit peuvent endommager l'abri et rendre son accès dangereux.

Visserie: Contrôler régulièrement les visserie et les resserrer comme il se doit.

Généralités: Effacer avec de l'eau et du savon les numéros de référence imprimés sur les panneaux peints.

Remarque : le fabricant décline toute responsabilité pour les conséquences d'un assemblage de l'abri non conforme à ces instructions ou pour les dommages liés aux intempéries ou aux catastrophes naturelles.

Conserver ces instructions d'assemblage et le manuel de l'utilisateur pour toute référence ultérieure.

SEGURIDAD Y CONSERVACIÓN

En todo momento, se **DEBEN** respetar las precauciones de seguridad durante la construcción de la estructura.

bordes filosos

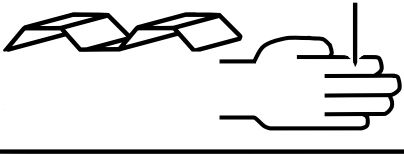

Tenga cuidado al manipular las diferentes piezas de la estructura ya que pueden tener bordes filosos. Utilice guantes de trabajo, protección para los ojos y mangas largas cuando monte la estructura o realice cualquier tarea de mantenimiento en esta.

siempre practique la seguridad de herramientas correcta

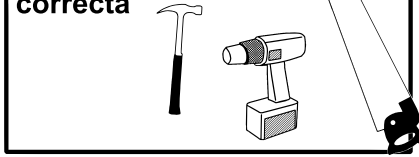

Tenga cuidado con las herramientas utilizadas en el montaje de esta estructura. Debe estar especialmente familiarizado con la operación de todas las herramientas mecánicas.



tenga cuidado con el viento

NO trate de montar la estructura en un día ventoso. Los paneles grandes pueden atrapar el viento como una "vela", lo que hace que sean llevados por el viento, lo que, a su vez, hace que la construcción sea difícil e insegura.

NO trate de montar la estructura antes de verificar que tenga todas las piezas indicadas en la lista de piezas y los accesorios para montaje. Cualquier estructura sin terminar puede ser dañada seriamente incluso por vientos ligeros.

no concentre peso en el techo

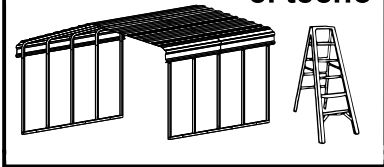

NUNCA concentre su peso en el techo de la estructura. Cuando utilice una escalera de mano, asegúrese de que esté completamente abierta y en terreno nivelado antes de subirse.

no permita entrar a niños ni animales domésticos en el lugar de trabajo



No permita entrar a niños ni animales domésticos en el lugar de trabajo durante la construcción y hasta que la estructura esté completamente montada. Esto ayudará a evitar distracciones y cualquier accidente que pueda producirse.

NOTA IMPORTANTE SOBRE EL ANCLAJE

- La estructura **DEBE** estar anclada para evitar daños por vientos. Consulte la página sobre anclaje para obtener más información.
- Además debe tener un sistema de anclaje provisorio en caso de que necesite descansar durante el montaje.

Protección exterior:

Para un acabado de larga duración, limpie la superficie exterior y coloque cera para automóviles. Le recomendamos que la lave con una solución de jabón suave. NO utilice hidrolavadora para limpiar el cobertizo. Se recomienda firmemente utilizar periódicamente una cera para automóviles en aerosol en el exterior si se encuentra en una región de clima costero o de mucha humedad.

Los combustibles y productos corrosivos deben guardarse en contenedores herméticos diseñados para almacenamiento de químicos o combustibles. Se deben limpiar inmediatamente los químicos corrosivos, como fertilizantes, pesticidas y herbicidas, de las superficies interiores y exteriores. El óxido causado por daños químicos no está cubierto por la garantía.

Las precauciones de protección contra el óxido pueden ayudarlo a evitar que se desarrolle óxido o a detenerlo tan pronto aparezca.

- Evite dañar o raspar la capa protectora, por dentro y por fuera.
- Mantenga el techo y el perímetro de la base sin desechos y hojas que podrían acumularse y retener la humedad. Estos pueden causar daño doble porque emiten ácido mientras se descomponen.
- Retoque las raspaduras o las muescas y cualquier área de todo óxido visible lo más pronto posible. Asegúrese de que el exterior no tenga humedad, aceites o mugre y entonces aplique una capa pareja de pintura para retoques de alta calidad.
- Varios fabricantes de pintura ofrecen productos para el tratamiento y la cobertura de óxido. Si aparece óxido en la superficie del cobertizo, le recomendamos que trate dichas áreas lo antes posible, siguiendo las instrucciones del proveedor de pintura de su elección.
- Nuestro departamento de servicio de atención al cliente puede ofrecerle la fórmula del color de pintura para que coincida con el color del cobertizo. Además tenemos pintura para retoques disponible para reparar pequeñas muescas o rayones.

Techo: Mantenga el techo sin hojas y nieve. Grandes cantidades de nieve en el techo pueden dañar la estructura haciéndola insegura.

Cierres: Inspeccione la estructura con frecuencia para determinar si hay cierres sueltos y ajustarlos de nuevo si es necesario.

General: Lave los números de piezas grabados con tinta en los paneles con revestimiento usando agua y jabón.

Tenga en cuenta que el fabricante no puede ser responsable de ninguna consecuencia a causa de estructuras que no hayan sido instaladas conforme estas instrucciones o por daños ocasionados por el clima o actos de Dios.

Conserve estas instrucciones de montaje y el manual del propietario para referencia futura.

SICHERHEIT UND INSTANDHALTUNG

Die Sicherheitsmaßnahmen MÜSSEN jederzeit befolgt werden, während Ihr Schuppen montiert wird!

scharfe Kanten

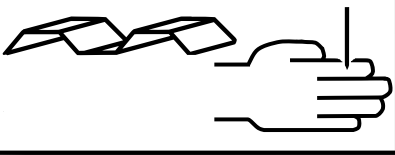

Verschiedene Teile Ihres Schuppens müssen vorsichtig gehandhabt werden, denn viele haben scharfe Kanten. Bitte tragen Sie Arbeitshandschuhe, Schutzbrille und langärmelige Kleidung, wenn Sie Ihren Schuppen montieren oder instand halten.

stets vorsichtig mit Werkzeug umgehen

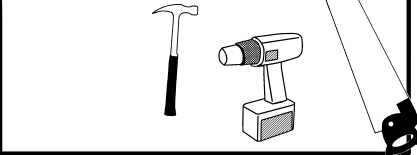

Gehen Sie mit den Werkzeugen, mit denen Sie diesen Schuppen montieren, vorsichtig um. Machen Sie sich insbesondere mit der Bedienung aller Elektrowerkzeuge vertraut.



Gefahr durch Wind

Versuchen Sie NICHT, Ihren Schuppen an einem windigen Tag aufzustellen. Die großen, flächigen Bauteile könnten wie ein Segel vom Wind erfasst und herumgeschleudert werden, was die Aufstellarbeiten erschwert und gefährlich macht.

Versuchen Sie NICHT, Ihren Schuppen zu montieren, bevor Sie sich nochmals vergewissert haben, dass Sie alle in der Teileliste aufgeführten Teile sowie alle Kleinteile haben. Ein nur teilweise montiert zurückgelassener Schuppen kann bereits durch leichten Wind schwer beschädigt werden.

Dach nicht punktuell belasten

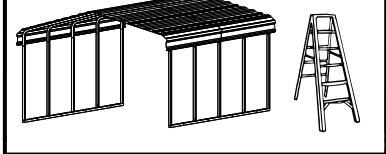

Belasten Sie das Dach des Schuppens NIEMALS punktuell mit Ihrem Gewicht. Vergewissern Sie sich bei Gebrauch einer Stehleiter, dass sie vollständig aufgeklappt ist und auf ebenerdig steht, bevor Sie sie besteigen.

Kinder und Haustiere von der Baustelle fernhalten



Halten Sie Kinder und Haustiere während der Montage und bis der Schuppen vollständig aufgestellt ist vom Aufstellplatz fern. Dies hilft, Ablenkungen und damit einhergehende Unfälle zu verhindern.

WICHTIGER HINWEIS ZUR VERANKERUNG

- Ihr Schuppen MUSS verankert werden, um Schäden durch Wind zu verhindern. Näheres entnehmen Sie bitte der Verankerungsseite.
- Sie brauchen ein vorübergehendes Verankerungssystem, falls Sie während der Montage eine Pause machen möchten.

Außenpflege:

Damit Sie lange Freude an Ihrem Schuppen haben, sollten die Außenflächen gereinigt und gewachst werden. Wir empfehlen, sie mit einer milden Seifenlauge abzuwaschen. Reinigen Sie Ihren Schuppen NICHT mit dem Hochdruckreiniger. Wenn Sie in einem Klima mit hoher Luftfeuchtigkeit oder in einer Küstenregion wohnen, empfehlen wir Ihnen dringend, regelmäßig ein Autowachs zum Aufsprühen zu verwenden.

Brennbare und ätzende Stoffe müssen in luftdichten Behältern gelagert werden, die zur Lagerung von Chemikalien und/oder Brennstoffen vorgesehen sind. Ätzende Chemikalien wie z. B. Dünger, Insektenvernichter und Unkrautvernichter sollten sofort von den Innen- und Außenflächen abgewischt werden. Durch die Lagerung von Chemikalien entstandener Rost wird nicht von der Gewährleistung abgedeckt.

Rostschutzmaßnahmen können helfen zu verhindern, dass Rost entsteht, oder ihn schnell aufhalten, sobald er auftritt.

- Vermeiden Sie es, die Oberflächenbeschichtung an der Innen- und Außenseite zu beschädigen oder zu kratzen.
- Halten Sie das Dach und den Bodenbereich stets frei von Verunreinigungen und Blättern, denn dort kann sich Feuchtigkeit ansammeln und gespeichert werden. Blätter können doppelt schädlich sein, denn sie geben beim Verrotten Säure ab.
- Bessern Sie Kratzer oder Beschädigungen und alle Bereiche mit sichtbarem Rost so schnell wie möglich aus. Achten Sie darauf, dass die Oberfläche frei von Feuchtigkeit, Ölen, Schmutz oder Dreck ist und tragen Sie dann eine gleichmäßig dicke Schicht eines hochwertigen Ausbesserungslacks auf.
- Verschiedene Lackhersteller bieten Produkte zur Rostbehandlung und -abdeckung an. Falls Oberflächenrost an Ihrem Schuppen erscheint, empfehlen wir, diese Bereiche so schnell wie möglich unter Befolgung der Anweisungen des Lackherstellers Ihrer Wahl zu behandeln.
- Unsere Kundendienstabteilung kann Ihnen die Farbmischformel für die Farbe Ihres Schuppens geben. Wir haben auch Ausbesserungslack zum Ausbessern kleiner Beschädigungen und Kratzer.

Dach: Halten Sie das Dach frei von Blättern und Schnee. Hohe Schneelasten auf den Dach können den Schuppen beschädigen und es gefährlich machen, ihn zu betreten.

Verschlüsse: Verschlüsse regelmäßig prüfen und ggf. nachziehen.

Allgemeines: Waschen Sie aufgedruckte Teilenummern auf lackierten Blechen mit Wasser und Seife ab.

Bitte beachten Sie, dass der Hersteller weder für die Folgen haftet, wenn ein Geräteschuppen nicht nach dieser Anleitung aufgestellt wurde, noch für Schäden aufgrund der Witterung oder höherer Gewalt.

Bewahren Sie diese Pflege- und Montageanleitung zum Nachschlagen auf.

ASSEMBLY TIPS & TOOLS

Watch the Weather Closely: Be sure the day you choose to install your building is dry and calm. Do **NOT** attempt to assemble your building on a windy day. Be careful on wet or muddy ground.

Use Teamwork: Two or more people are required to assemble your building. One person can hold the parts or panels in place while the other person fastens them together and handles the tools. This makes the process of assembling your building faster and safer.

Tools and Materials: Here is a list of some basic tools and materials you will need to assemble your building. Decide which method of anchoring and the type of base you will use to make a complete list of the materials you will need.

WHAT YOU NEED

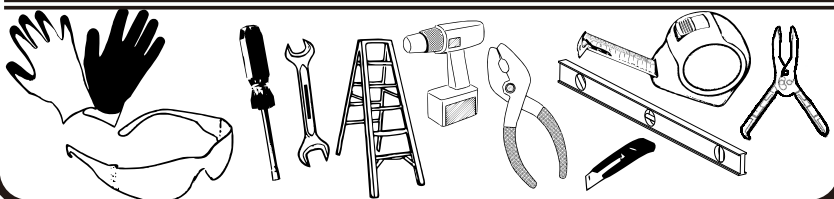

- Work Gloves
- Safety Glasses
- Nut Driver or Wrench
- Step Ladder 8'
- Power Drill (Cordless, Variable Speed)
- Pliers
- Utility Knife or Scissors
- Carpenter's Level
- Tape Measure
- Clamp

RECOMMENDED TIME SAVERS



- Square
- String (for squaring the frame)
- Awl (to align holes)

BASE PREPARATION TOOLS

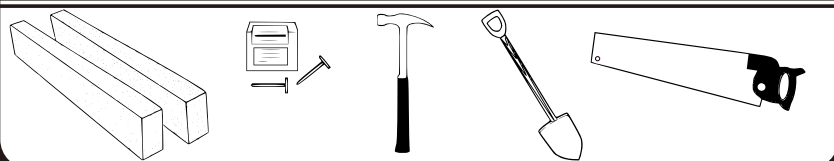

- Lumber and/or Concrete
- Hammer and Nails
- Spade or Shovel
- Hand Saw or Power Saw

How to Select and Prepare Your Building Site: Before you start to assemble your building, you will want to decide on a good location. The best location is a level area with good drainage.

- Allow enough working space so it is not difficult to move parts into position for assembly. Also, there needs to be enough space outside the building to be able to fasten the panel screws from the outside.
- Before assembling any parts, your base should be constructed and an anchoring system should be ready to use.

CONSEILS ET OUTILS D'ASSEMBLAGE

Suivre la météo avec attention : Veiller à choisir un jour sec et calme pour le montage de l'abri. Ne **PAS** tenter d'assembler l'abri en présence de vent. Faire preuve de prudence sur les sols mouillés ou boueux.

Travailler en équipe : Deux personnes ou plus sont nécessaires pour assembler l'abri. Une personne peut tenir les pièces ou panneaux en place pendant que l'autre les attache et utilise les outils. Le processus d'assemblage de l'abri en sera plus rapide et plus sécuritaire.

Outils et matériels : La liste ci-dessous indique certains des outils et matériels de base nécessaires pour l'assemblage de l'abri. Choisir la méthode d'ancrage et le type de base à utiliser pour compléter la liste du matériel nécessaire.

CE QU'IL VOUS FAUT (NON FOURNI)

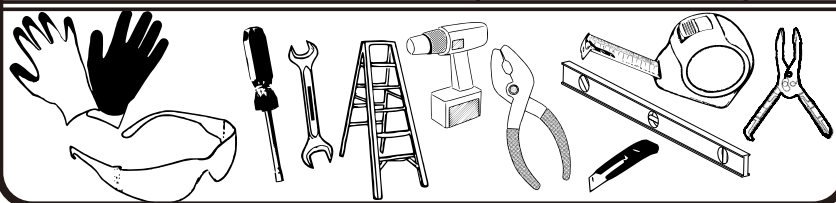

- Gants de travail
- Lunettes de sécurité
- Tourne-écrou ou clé
- Escabeau 8'
- Perceuse électrique (sans fil, vitesse variable)
- Pince
- Couteau utilitaire ou ciseaux
- Niveau de charpentier
- Ruban à bulles
- Serrer

POUR GAGNER DU TEMPS



- Équerre
- Ficelle (pour mettre le cadre d'équerre)
- Poinçon (pour aligner les trous)

OUTILS DE PRÉPARATION DE LA BASE

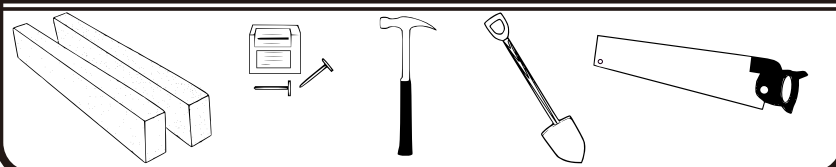

- Bois de construction et/ou béton
- Marteau et clous
- Bêche ou pelle
- Scie à main ou scie électrique

Comment sélectionner et préparer l'emplacement pour l'abri : Avant de commencer à assembler l'abri, il convient de choisir un bon emplacement. Le meilleur emplacement sera une surface de niveau à bon drainage.

- Prévoir un espace de travail suffisant afin de pouvoir déplacer les pièces sans difficulté. S'assurer qu'il y a suffisamment de place pour ouvrir complètement les portes. De même, il doit y avoir assez d'espace autour de l'abri pour pouvoir serrer les vis des panneaux depuis l'extérieur.
- Avant de commencer à assembler des pièces, la base doit avoir été construite et le système d'ancrage doit être prêt à l'emploi.

HERRAMIENTAS Y CONSEJOS DE MONTAJE

Observe el clima atentamente: Asegúrese de que el día que elija para instalar la estructura sea un día seco y tranquilo. **NO** trate de montar la estructura en un día ventoso. Tenga cuidado al trabajar en terreno mojado o embarrado.

Trabaje en equipo: Se necesitan dos o más personas para ensamblar su cobertizo. Una persona puede sujetar las partes o los paneles en su lugar, mientras que la otra los asegura juntos y se encarga de las herramientas. Esto hace que el proceso de ensamblaje de su cobertizo sea más rápido y más seguro.

Herramientas y materiales: A continuación, se presentan algunas herramientas y materiales básicos que necesitará para montar la estructura. Decida qué método de anclaje y qué tipo de base utilizará para preparar una lista completa de los materiales que necesitará.

LO QUE NECESITA

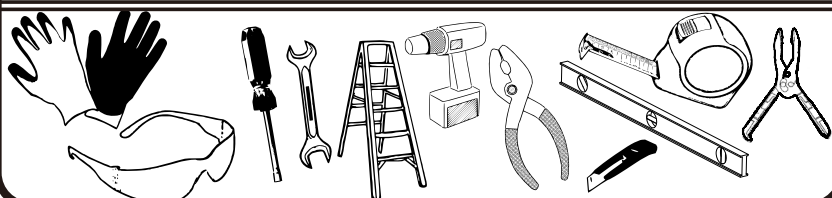

- Guantes de trabajo
- Gafas de seguridad
- Llave para tuercas o llave inglesa
- Escalera de mano 8'
- Taladro eléctrico (sin cordón, velocidad variable)
- Alicata
- Cuchillo multiuso o tijeras
- Nivel de carpintero
- Cinta métrica
- Abrazadera

MÉTODOS RECOMENDADOS PARA AHORRAR TIEMPO



- Escuadra
- Cuerda (para encuadrar el armazón)
- Punzón (para alinear orificios)

HERRAMIENTAS PARA LA PREPARACIÓN DE LA BASE

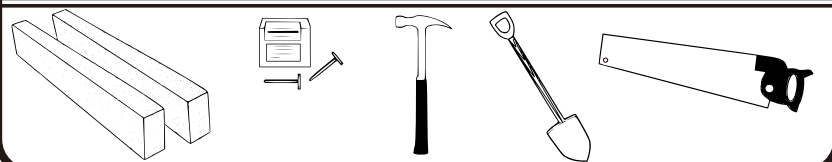

- Madera u hormigón
- Martillo y clavos
- Pala con o sin punta
- Serrucho de mano o serrucho mecánico

Cómo seleccionar y preparar el lugar de la estructura: Antes de empezar a montar la estructura, deberá elegir un buen lugar. El mejor lugar es un área nivelada con buen drenaje.

- Prepare un área suficientemente grande para que no sea difícil colocar las piezas en su lugar durante el montaje. Además, debe haber suficiente espacio alrededor de la estructura para poder fijar los tornillos del panel desde afuera.
- Antes de montar cualquier pieza, debe estar construida la base y preparado el sistema de anclaje.

MONTAGETIPPS UND -WERKZEUGE

Achten Sie immer auf das Wetter: Versichern Sie sich, dass Sie für die Montage einen windstillen Tag ohne Regen auswählen. Versuchen Sie NIE, ein Gerätehaus an einem windigen Tag zu montieren. Seien Sie besonders vorsichtig, wenn der Boden naß oder schlammig ist.

Arbeiten Sie im Team: Mindestens zwei Personen werden für die Montage des Gerätehauses benötigt. Eine Person hält die Teile oder Paneele, während die andere sie verschraubt und die Werkzeuge benutzt. Dadurch wird der Montagevorgang schneller und sicherer.

Werkzeuge und Materialien: Nachstehend eine Liste der Werkzeuge und Materialien, die Sie unbedingt für den Zusammenbau des Gerätehauses benötigen. Wählen Sie die Verankerungsmethode und die Art des Sockels, die Sie vorziehen, und vervollständigen Sie die Liste der Materialien, die Sie benötigen.

NACHSTEHEND, WAS SIE BENÖTIGEN

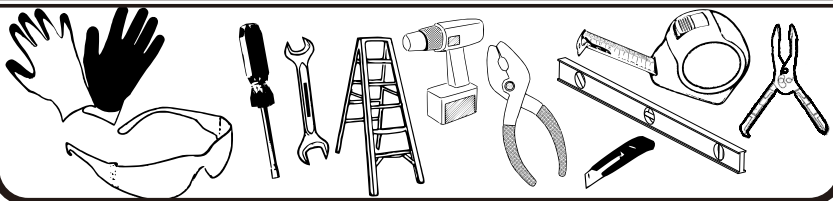

- Schutzhandschuhe
- Schutzbrille
- Steckschlüssel oder Schraubenschlüssel
- Stufenleiter 8'
- Bohrmaschine (schnurlos, variable Geschwindigkeiten)
- Zange
- Allzweckmesser oder Schere
- Wasserwaage
- Maßband
- Klemme

EMPFOHLENE ZEITSPARER



- Vierkant
- Schnur (um den Rahmen rechtwinklig zu machen)
- Pfriem (zur Ausrichtung der Bohrungen)

WERKZEUGE ZUR VORBEREITUNG DES FUNDAMENTS

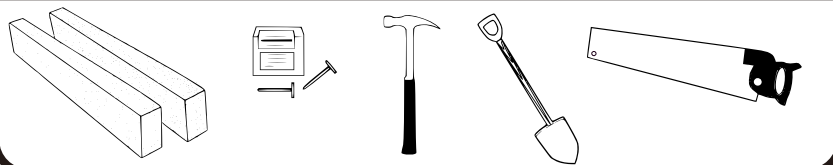

- Holz und/oder Beton
- Hammer und Nägel
- Spaten oder Schaufel
- Handsäge oder Motorsäge

Wahl und Vorbereitung des Bauplatzes: Vor der Montage des Gerätehauses müssen Sie sich entscheiden, wo Sie es errichten möchten. Der bestmögliche Bauplatz ist eben mit einer guten Drainage.

• Sehen Sie genügend Arbeitsraum vor, so dass Teile leicht in die Montageposition gebracht werden können. Versichern Sie sich, dass am Eingang genügend Freiplatz bleibt, um die Türen komplett öffnen zu können. Es muß außerdem genügend Platz außerhalb des Gerätehauses vorgesehen werden, damit die Blechschrauben von außen aus verschraubt werden können.

• Das Fundament sollte vor dem Zusammenbau der Teile gebaut und das Verankerungssystem nutzungsbereit sein.

ASSEMBLY TIPS & TOOLS



The extra part of the model A screw is used for the situation shown in the circle above, and the customer decides whether to install it, if installed, as shown in the circle below.



1

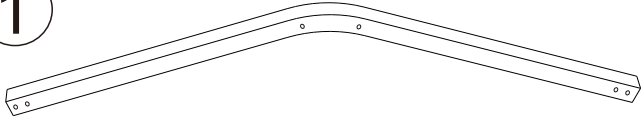

X5

5

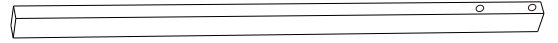

X2

2

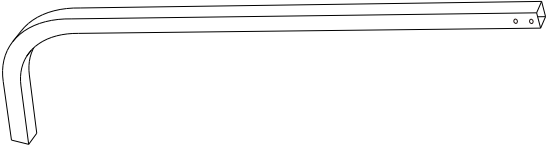

X6

6

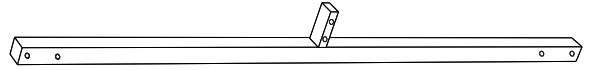

X1

3

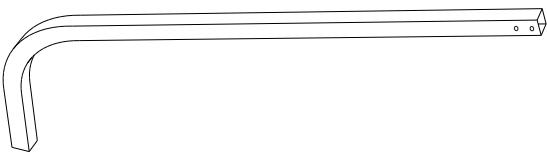

X4

6L

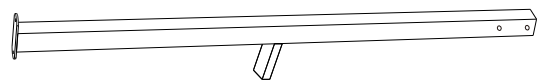

X2

4

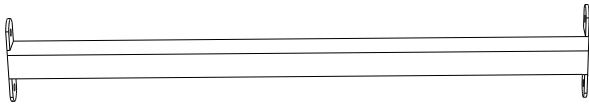

X9

6R



X2

4A

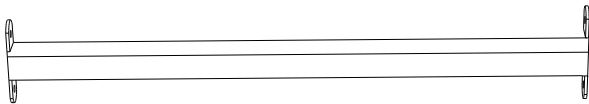

X1

7

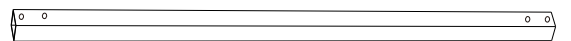

X5

4B

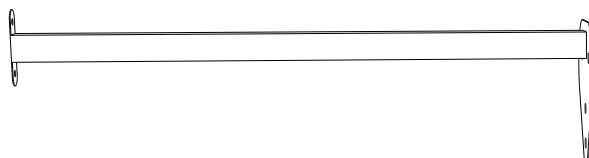

X2

7A

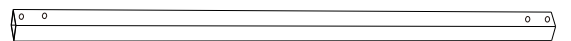

X1

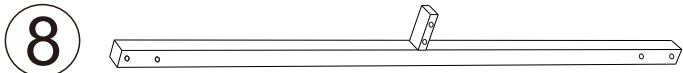

X7

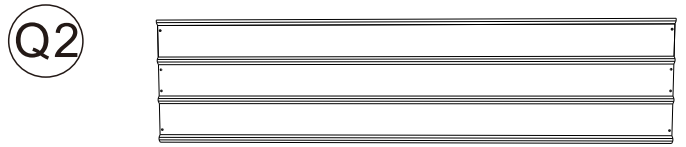

X46



X1

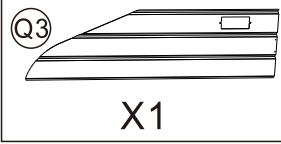

X1

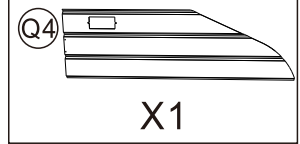

X1

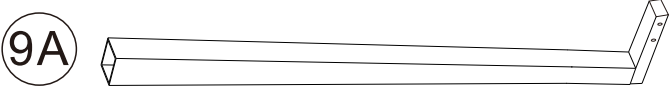

X1

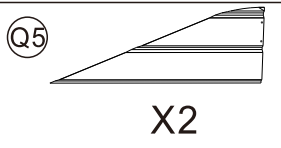

X2

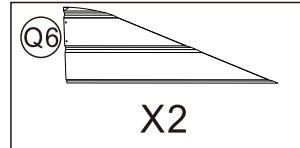

X2

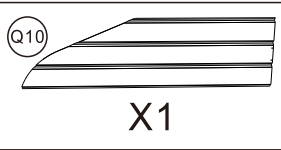

X1

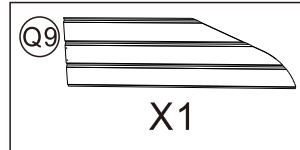

X1

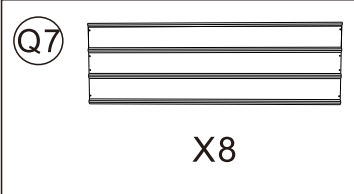

X8

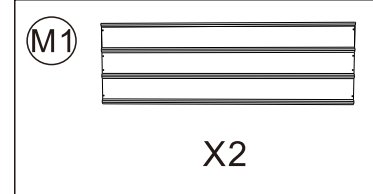

X2



X4

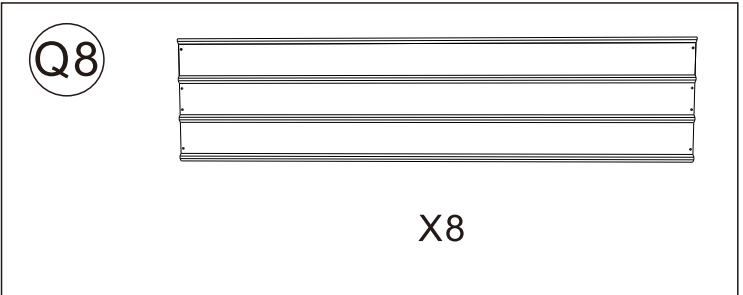

X8

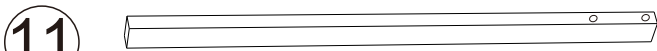

X1

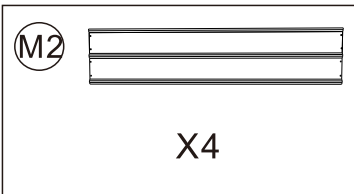

X4

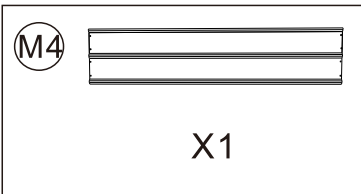

X1

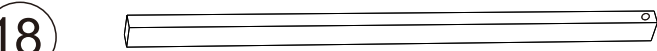

X2

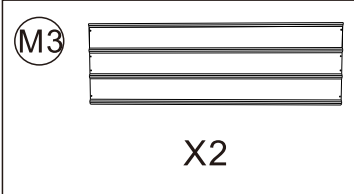

X2

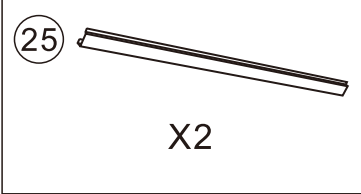

X2

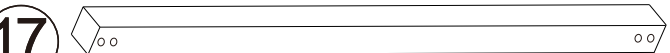

X4

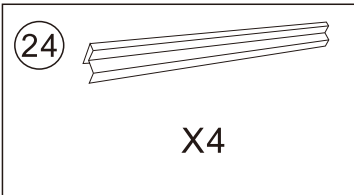

X4

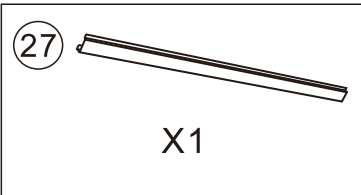

X1

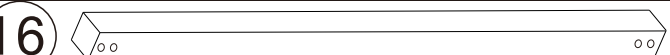

X2

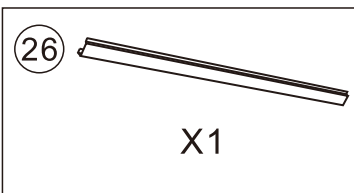

X1

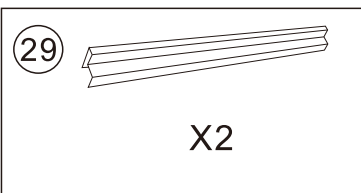

X2



X18

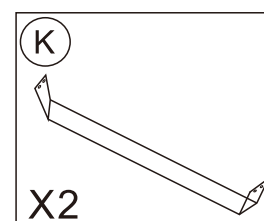
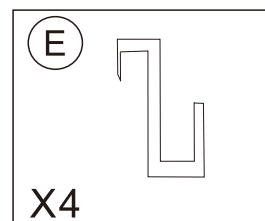
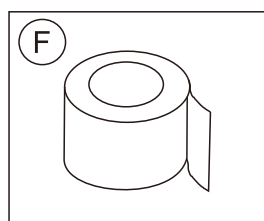
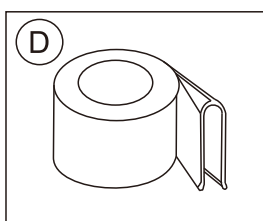
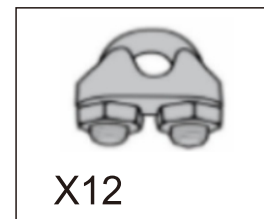
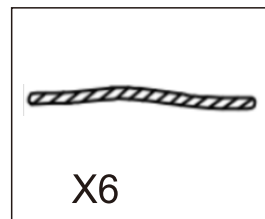
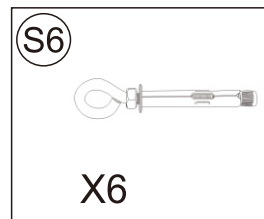
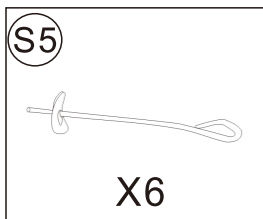
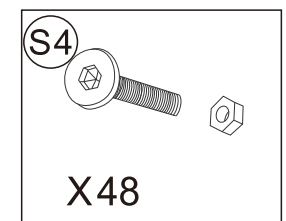
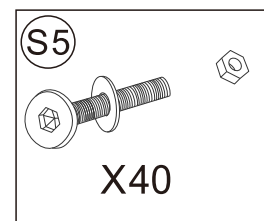
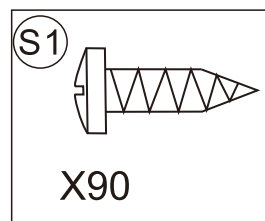
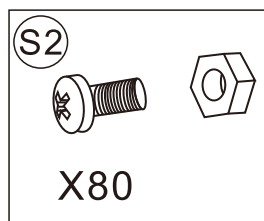
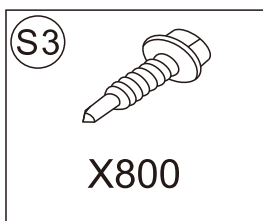
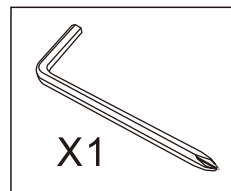
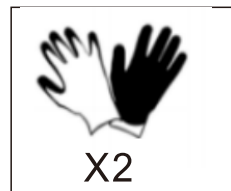
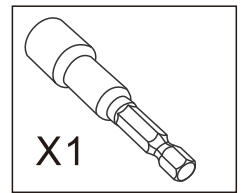
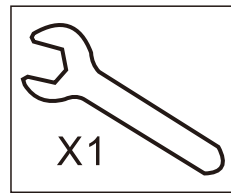
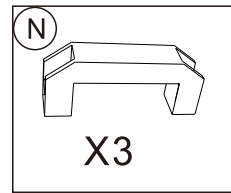
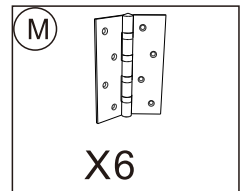
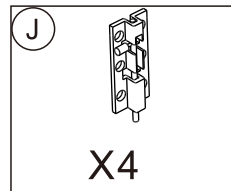
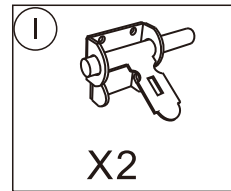
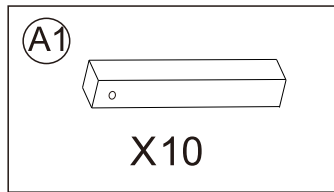
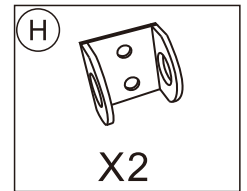
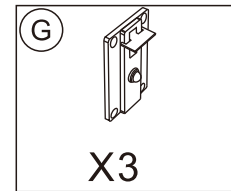
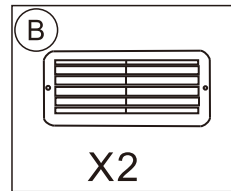
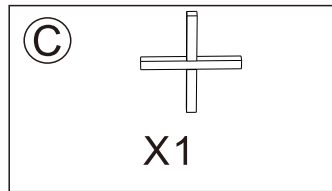
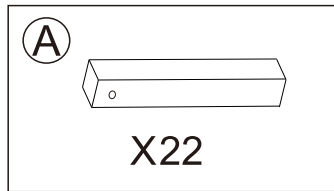
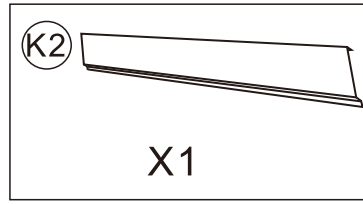
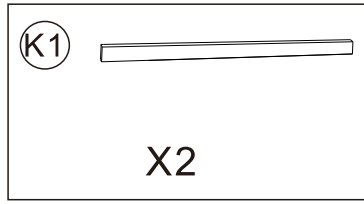
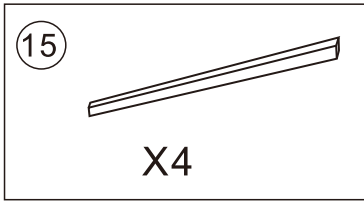
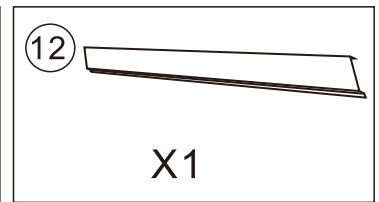
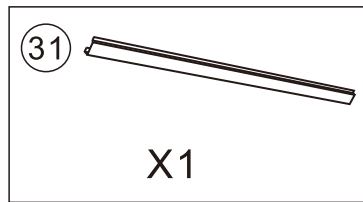
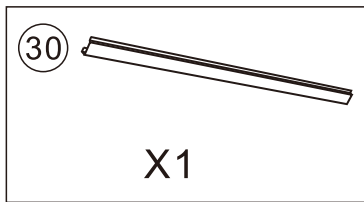
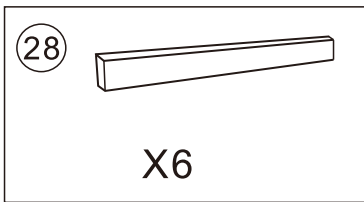

Connect each pipe fitting with screws as shown

STEP-2

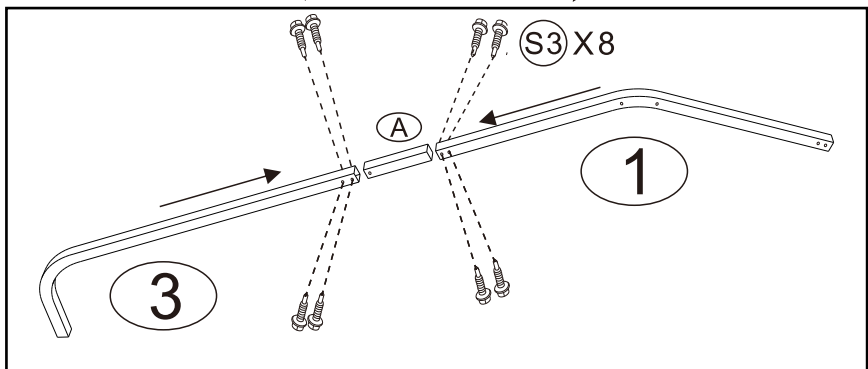
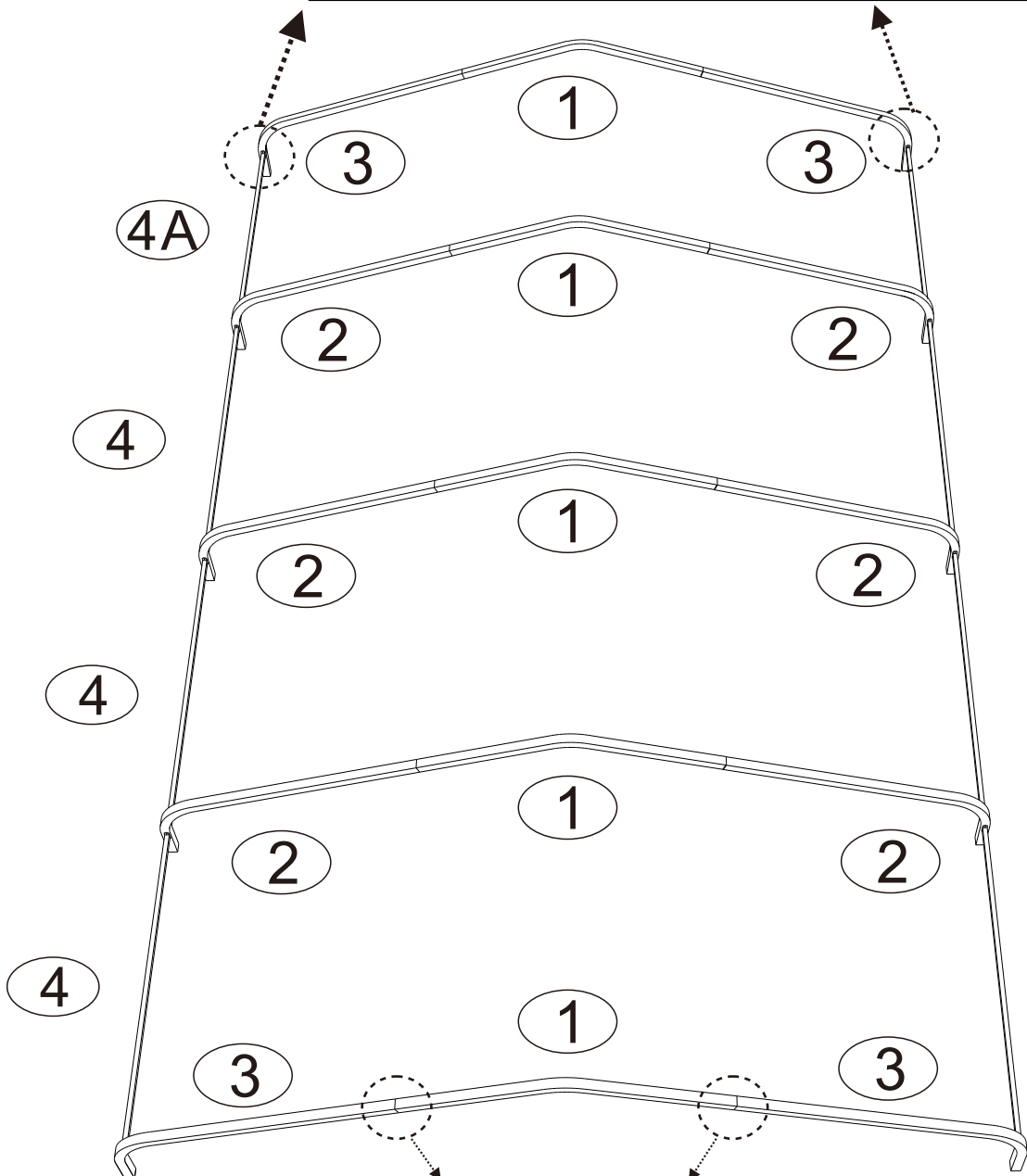
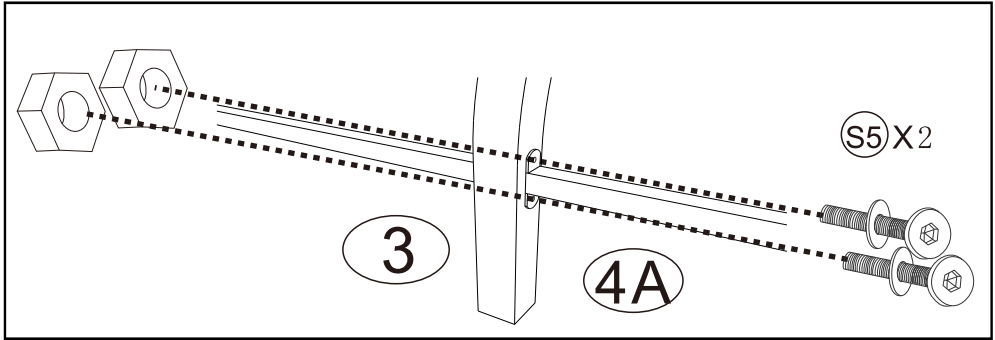

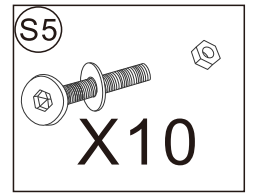
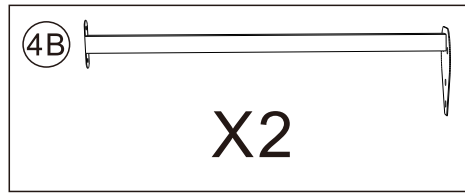
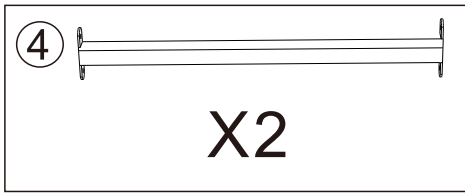

STEP-3

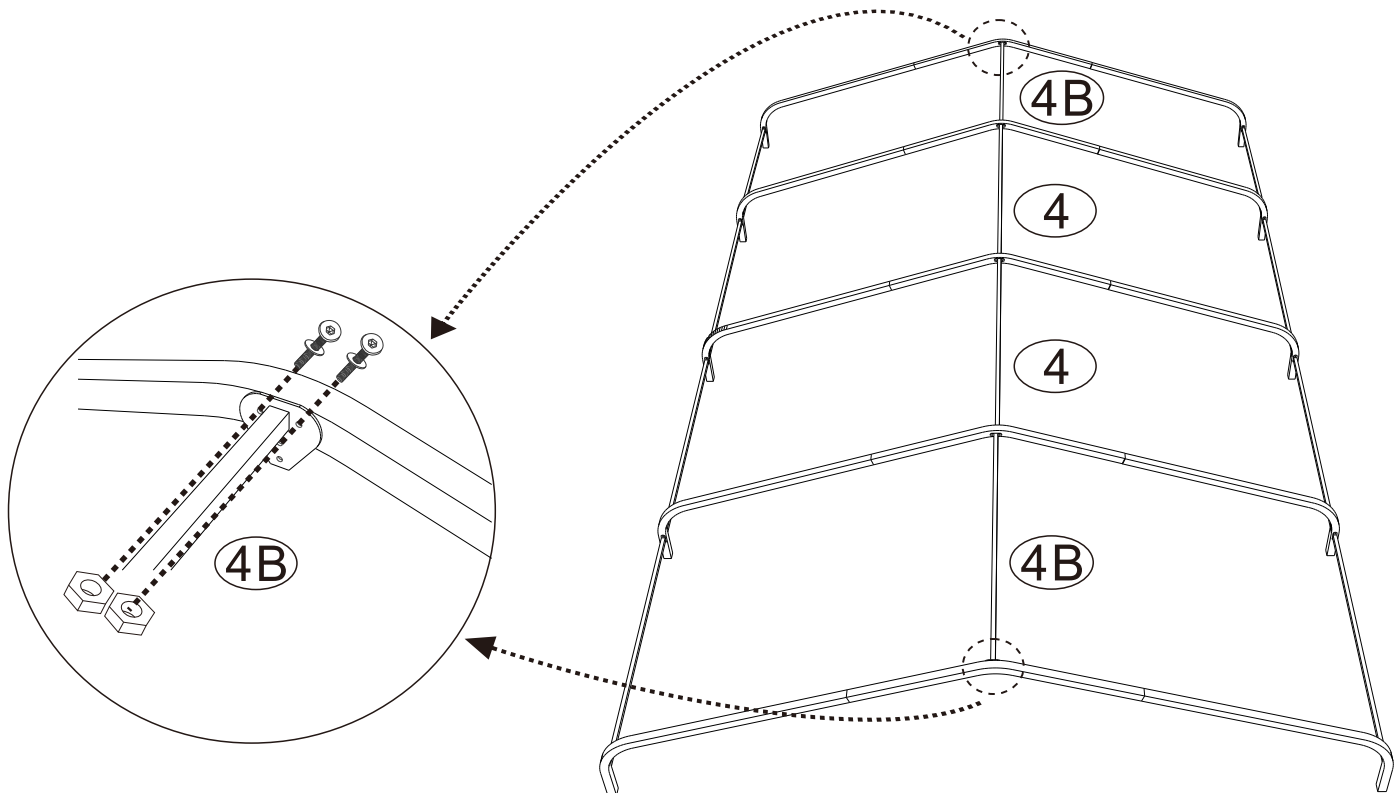
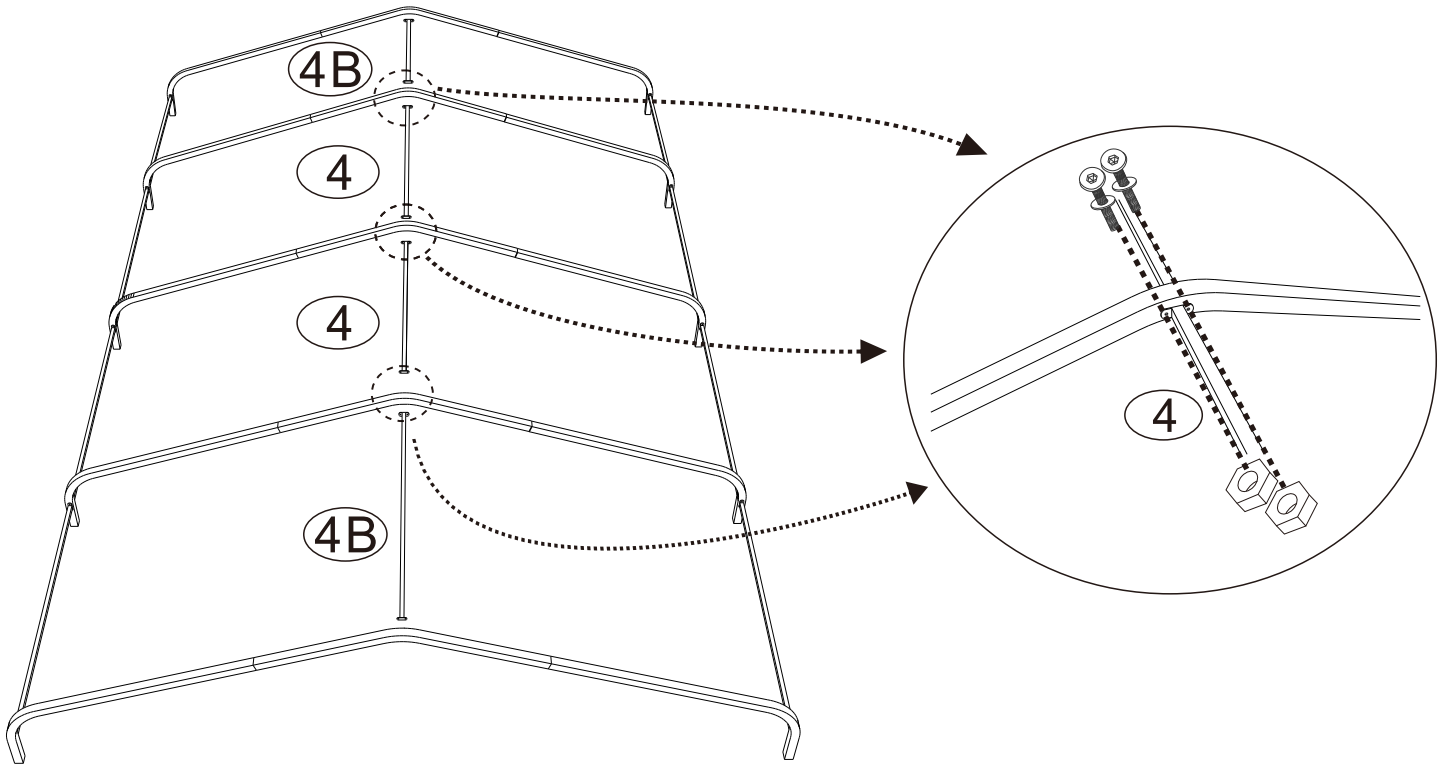

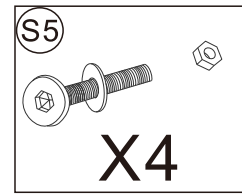
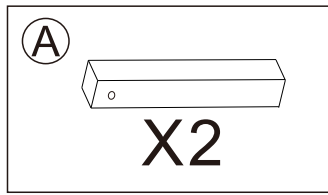
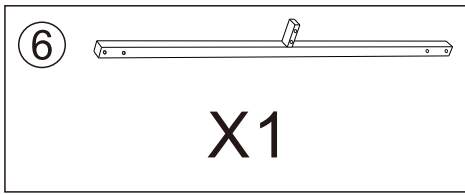
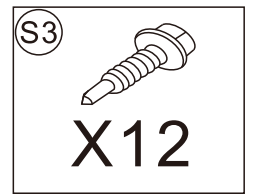
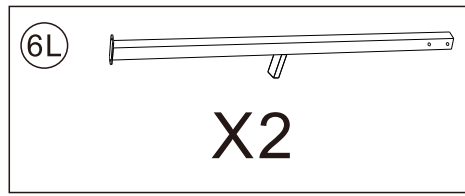
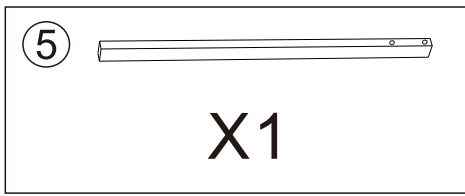

STEP-4

Install the upper frame above the front door opening

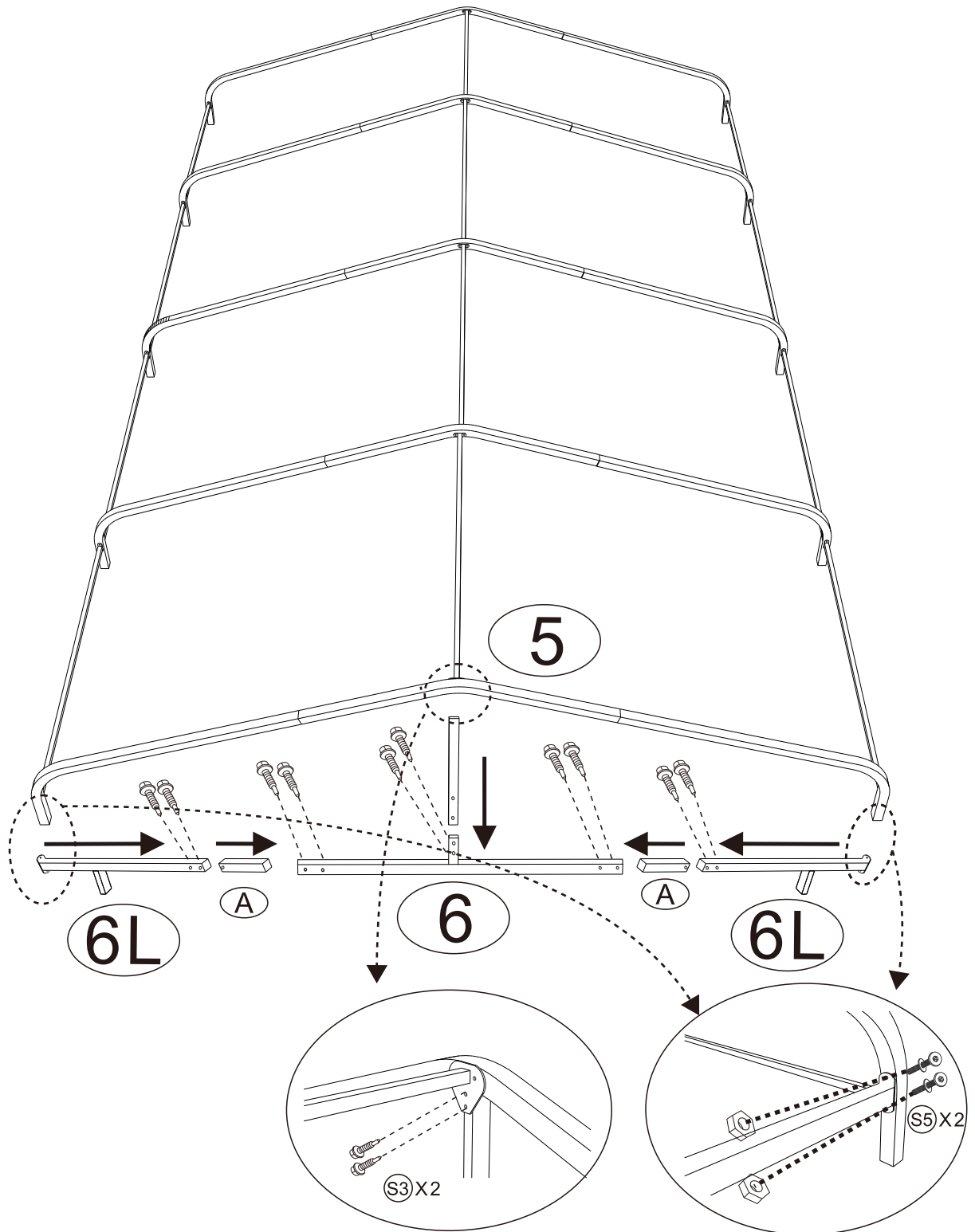

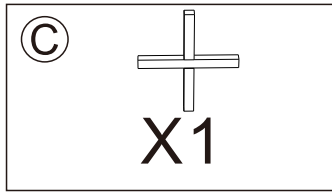
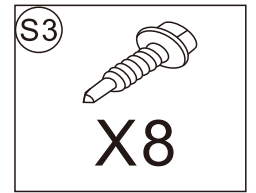
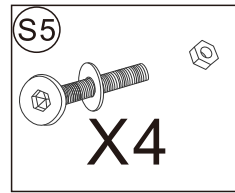
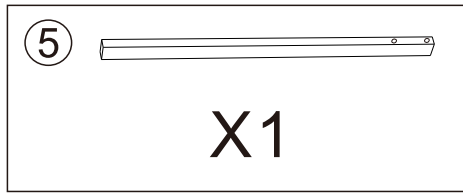
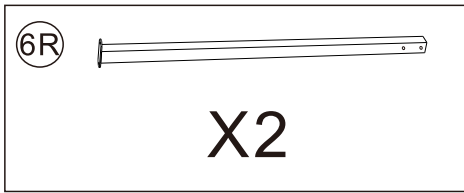

STEP-5

Install the top frame on the rear side of the storage shed

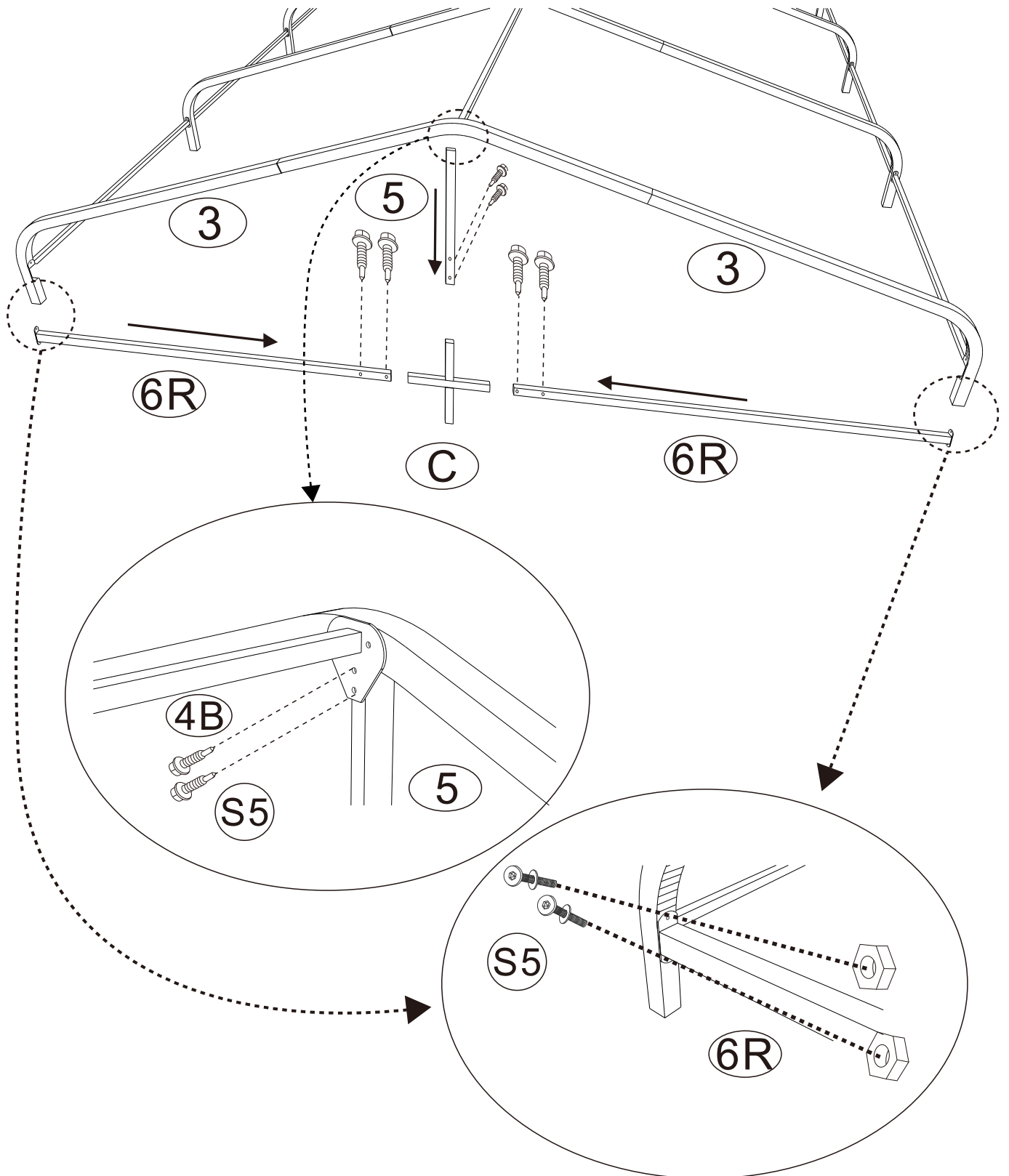

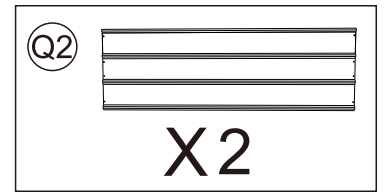
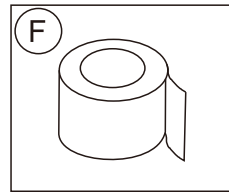
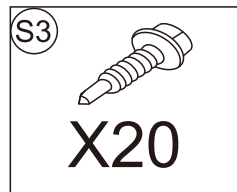
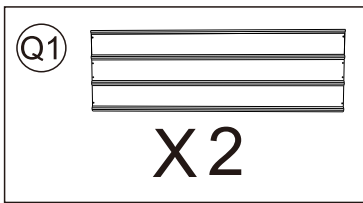

STEP-6

The waterproof strip is affixed to the iron pipe and do not cover the screw hole

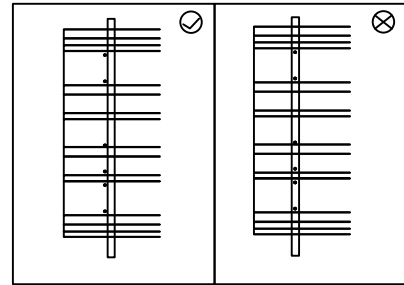
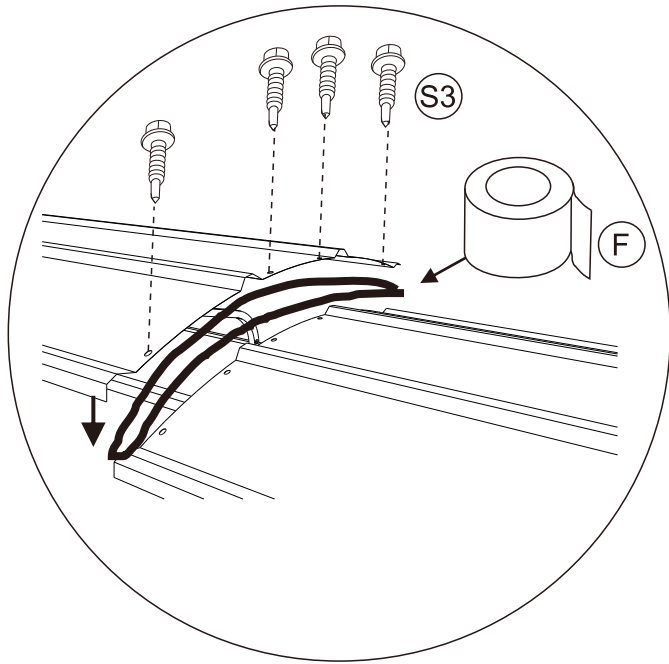

Color steel tile laying to a direction , then and drainage

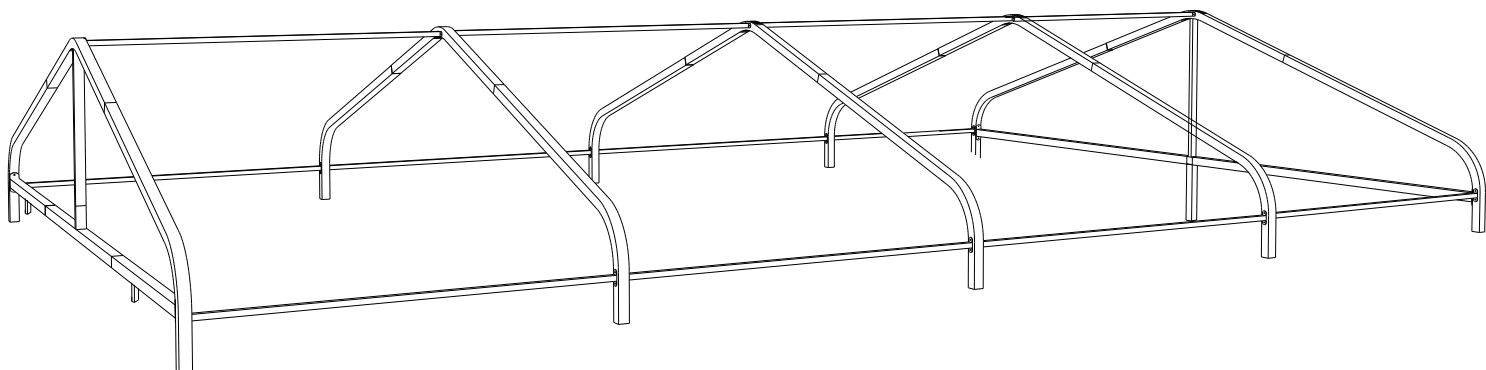
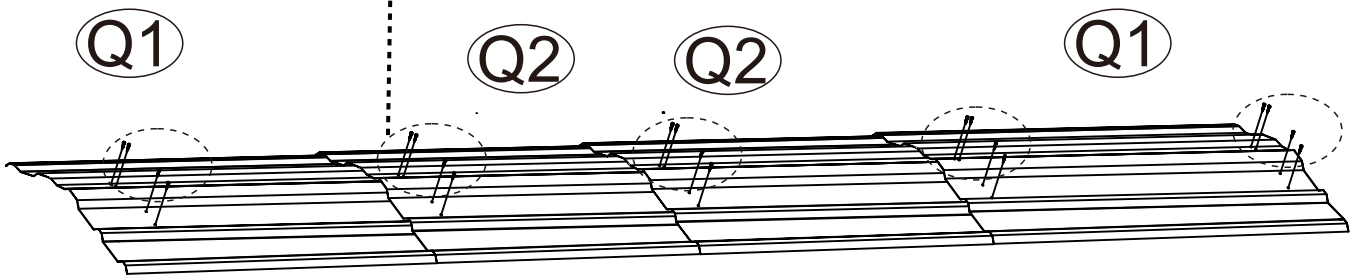
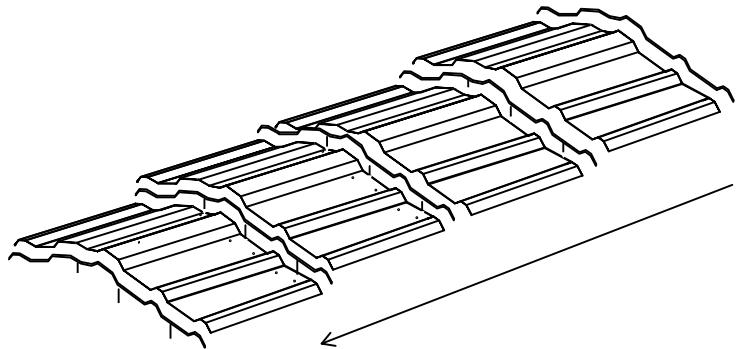

STEP-7

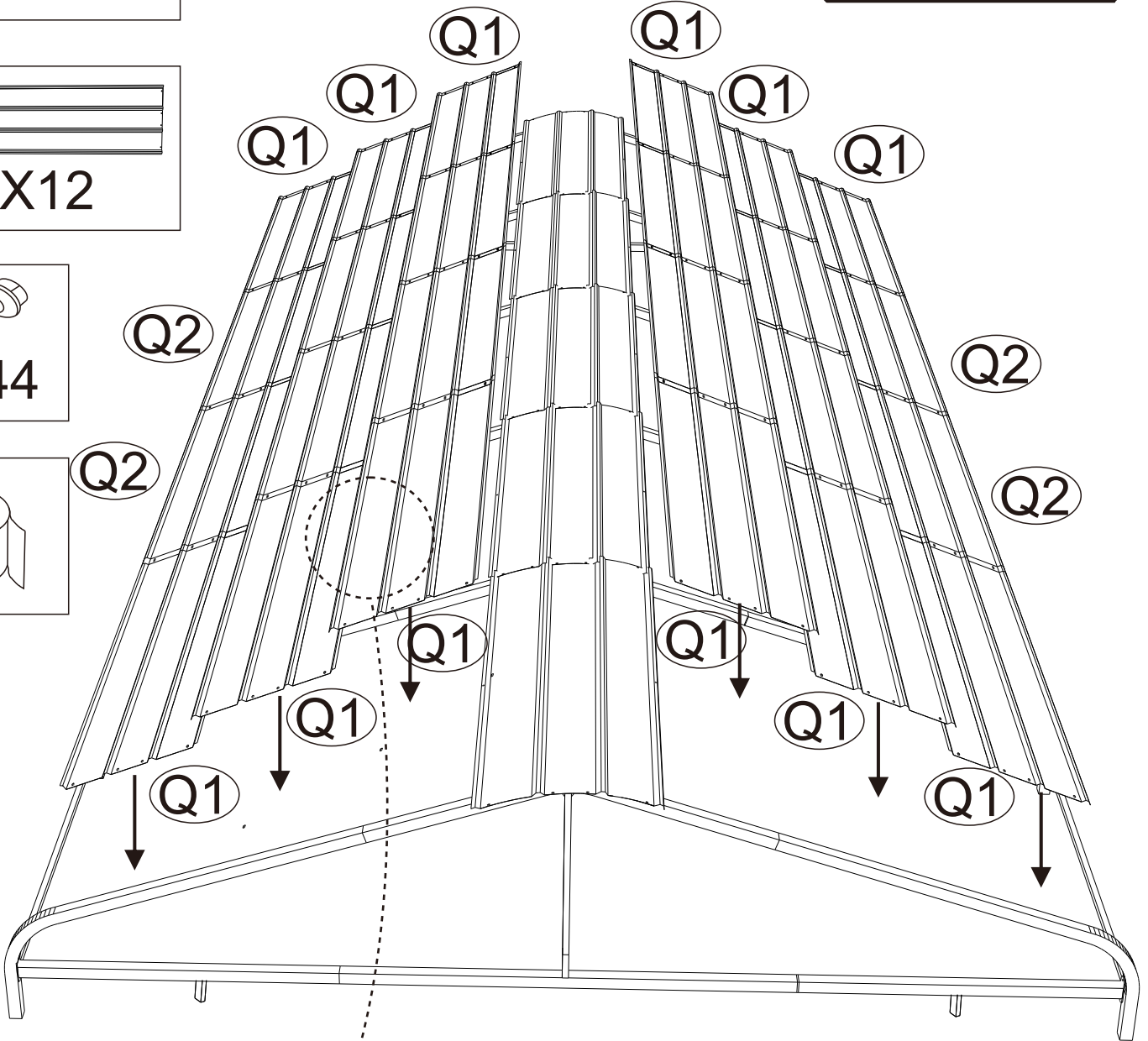
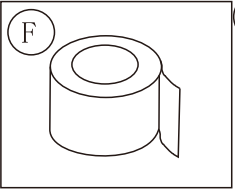
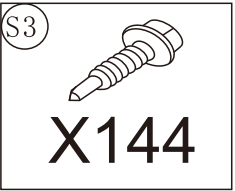
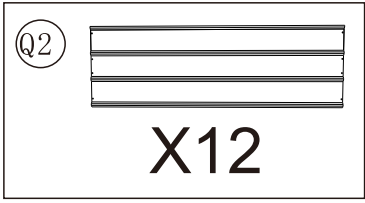
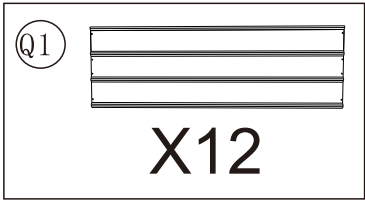

The waterproof strip is affixed to the iron pipe and do not cover the screw hole

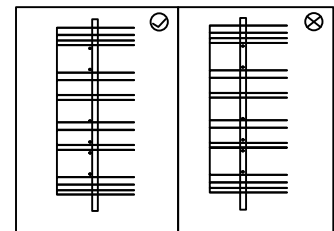
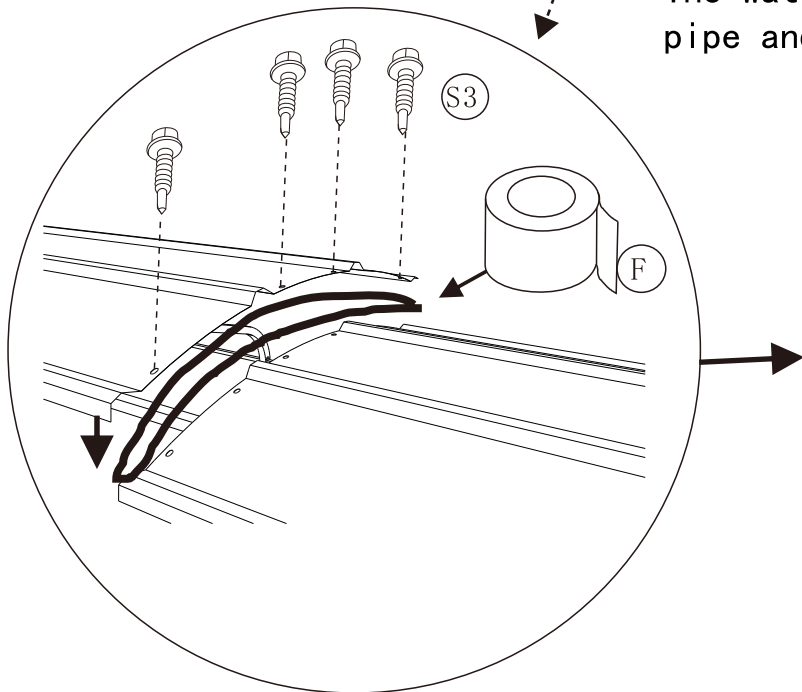

Color steel tile laying to a direction ,then and drainage

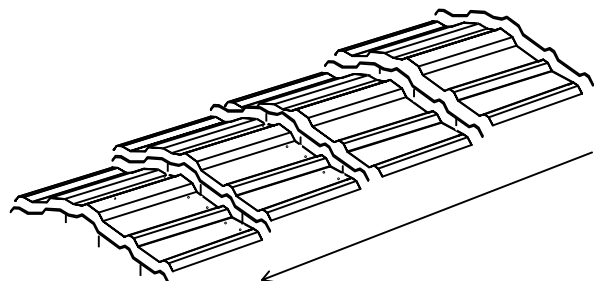

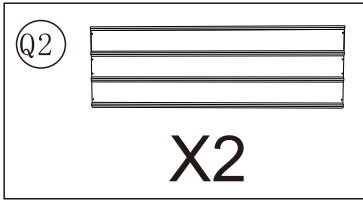
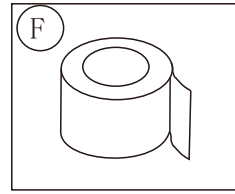
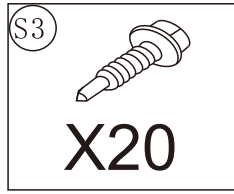
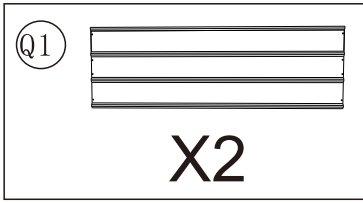

STEP-8

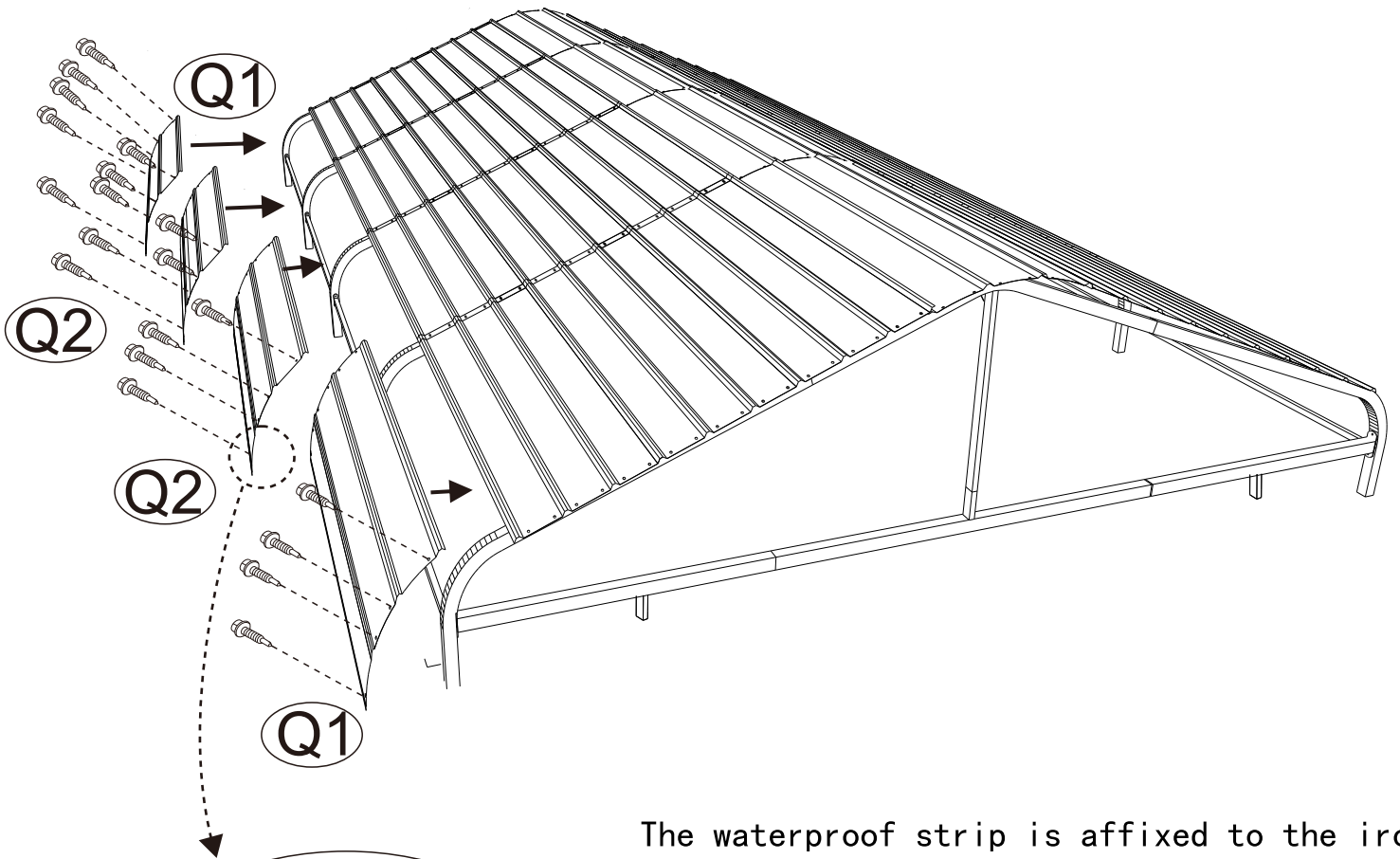

The waterproof strip is affixed to the iron pipe and do not cover the screw hole

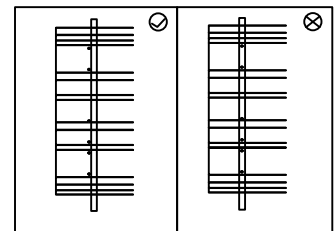

Color steel tile laying to a direction ,then and drainage

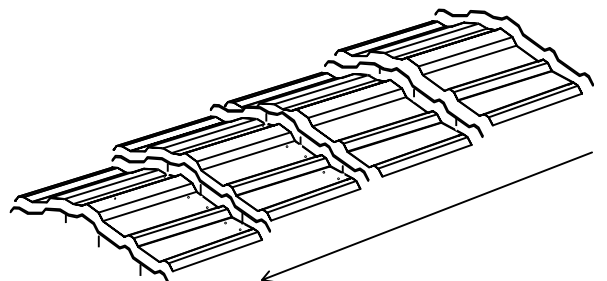

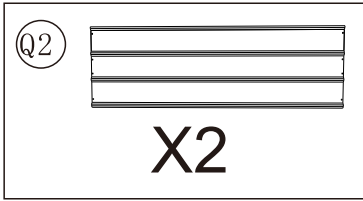
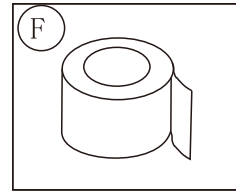
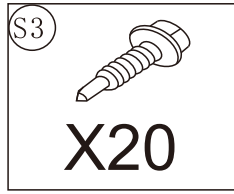
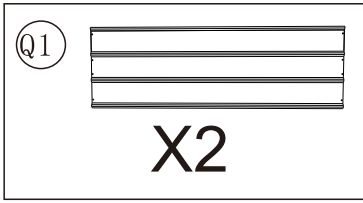

STEP-9

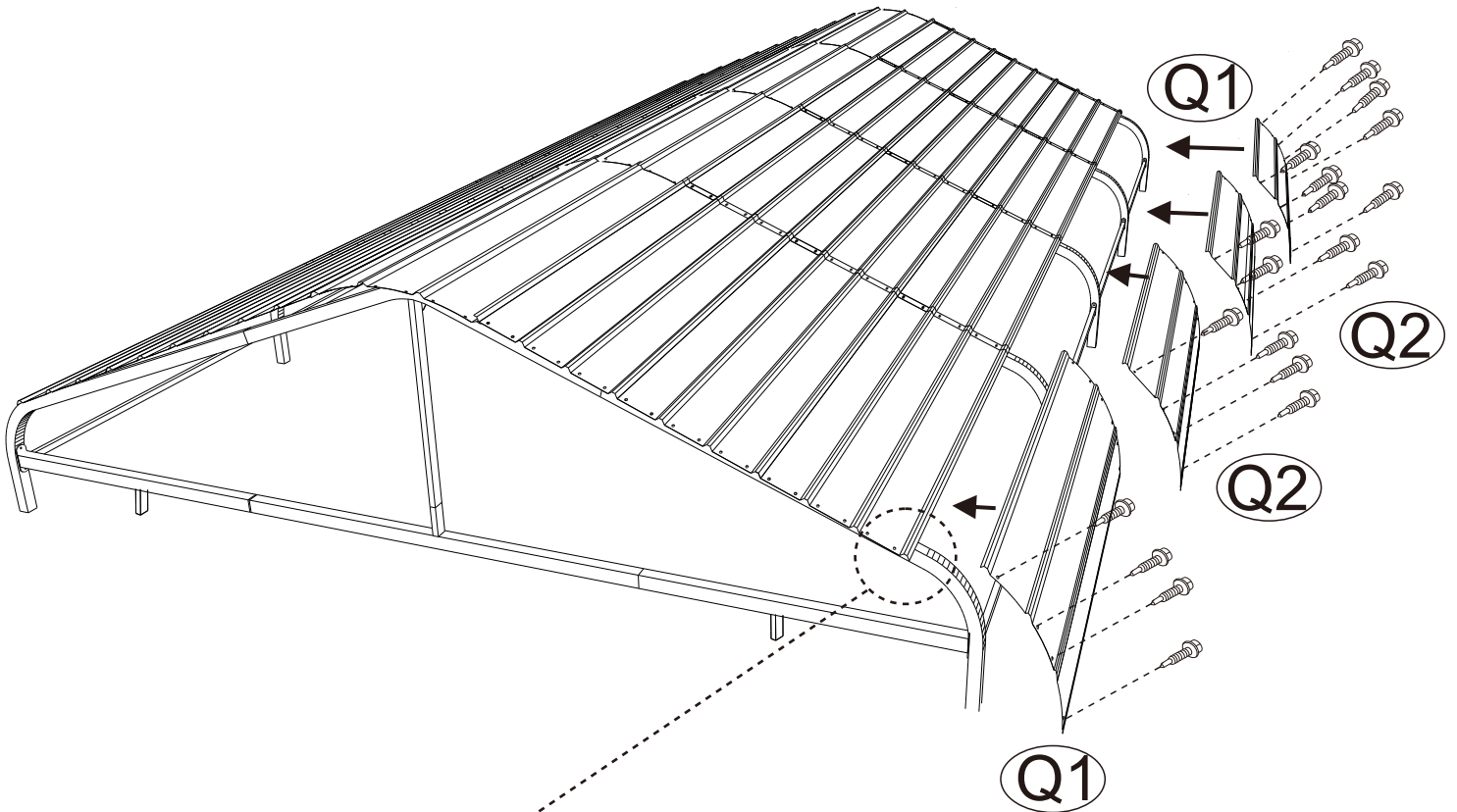

The waterproof strip is affixed to the iron pipe and do not cover the screw hole

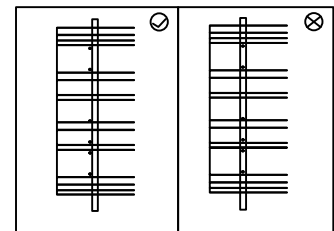
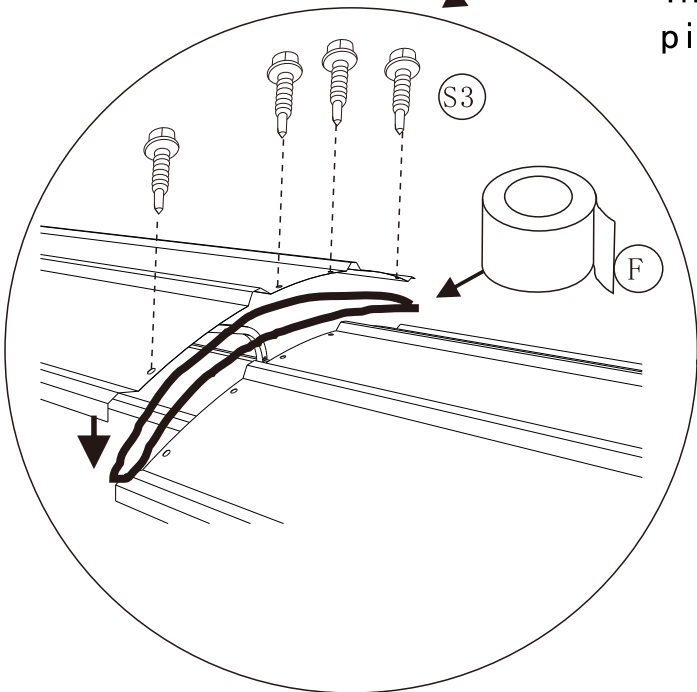

Color steel tile laying to a direction ,then and drainage

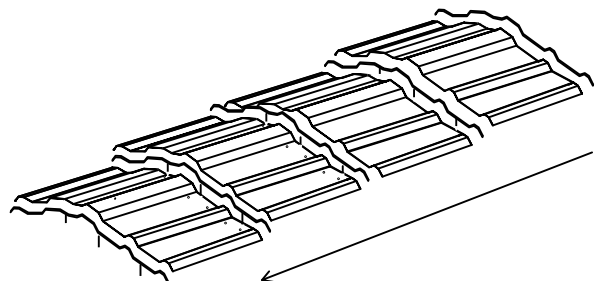

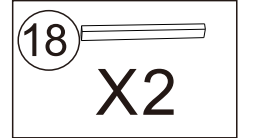
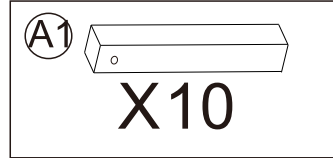
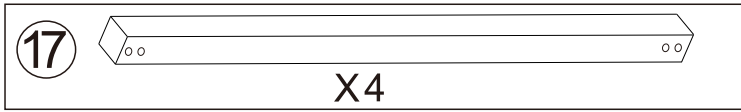
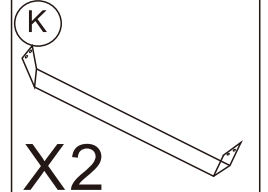
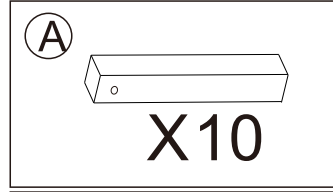
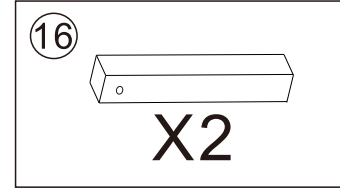
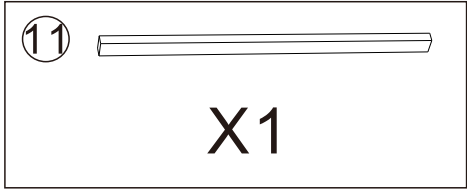
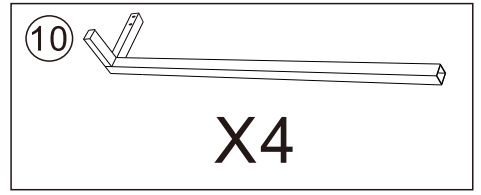
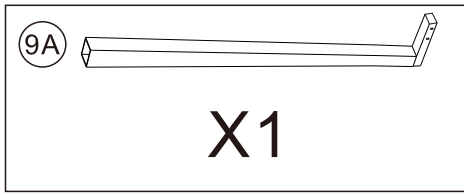
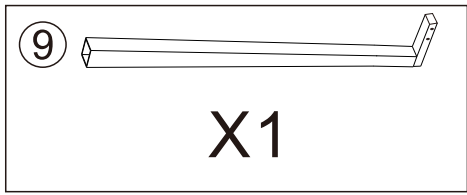
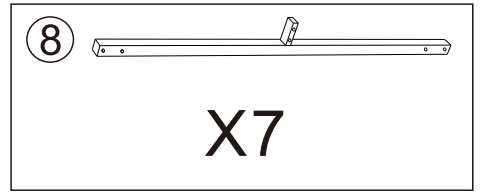
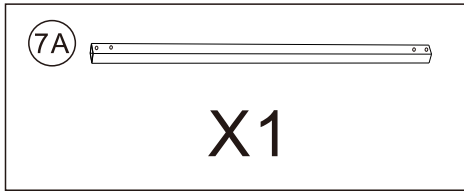
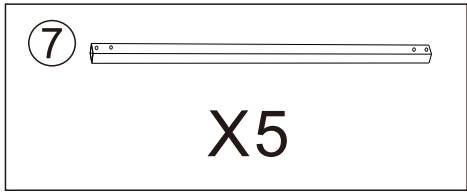

STEP-10

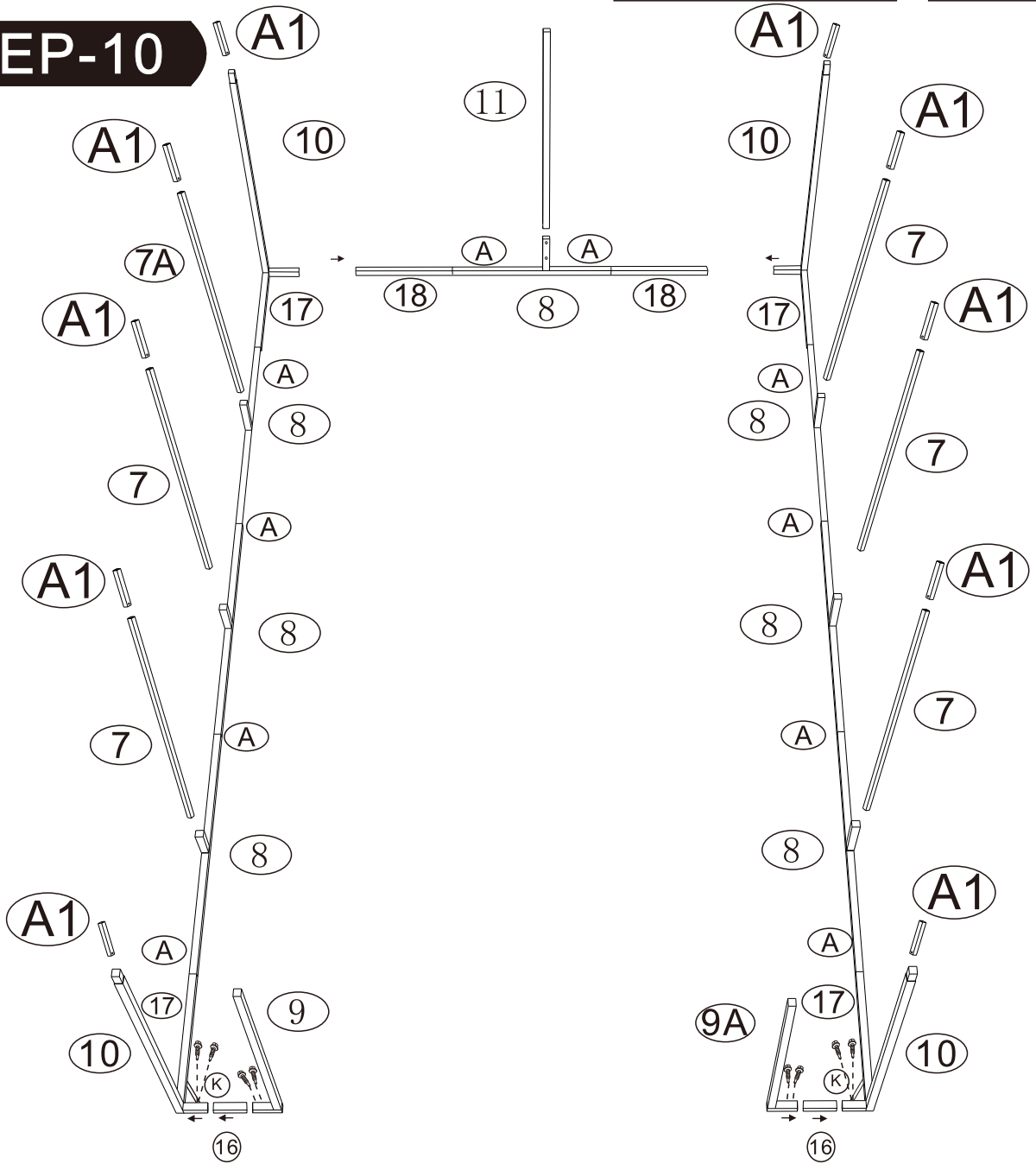

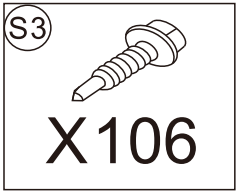

STEP-11

Assemble lower carport section - note main gate orientation and side frame part numbers

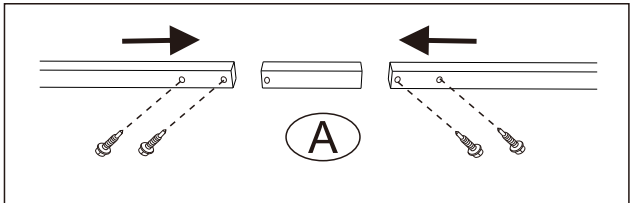
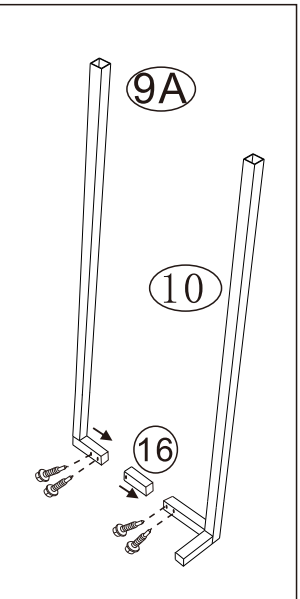
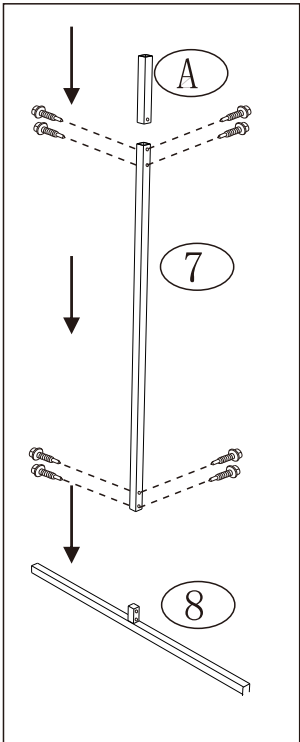
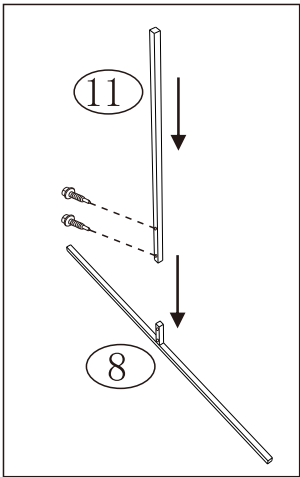
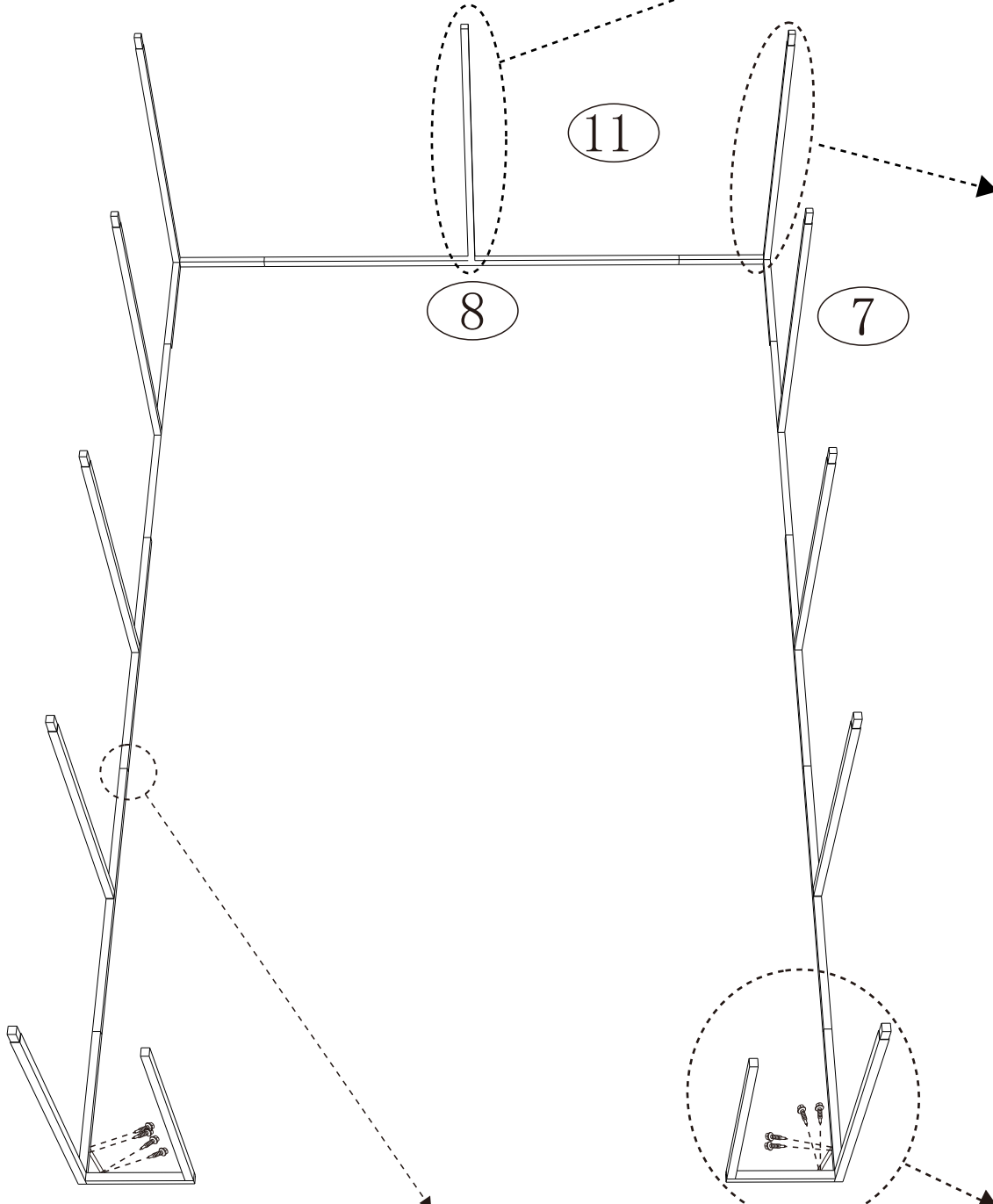

S3



X48

STEP-12

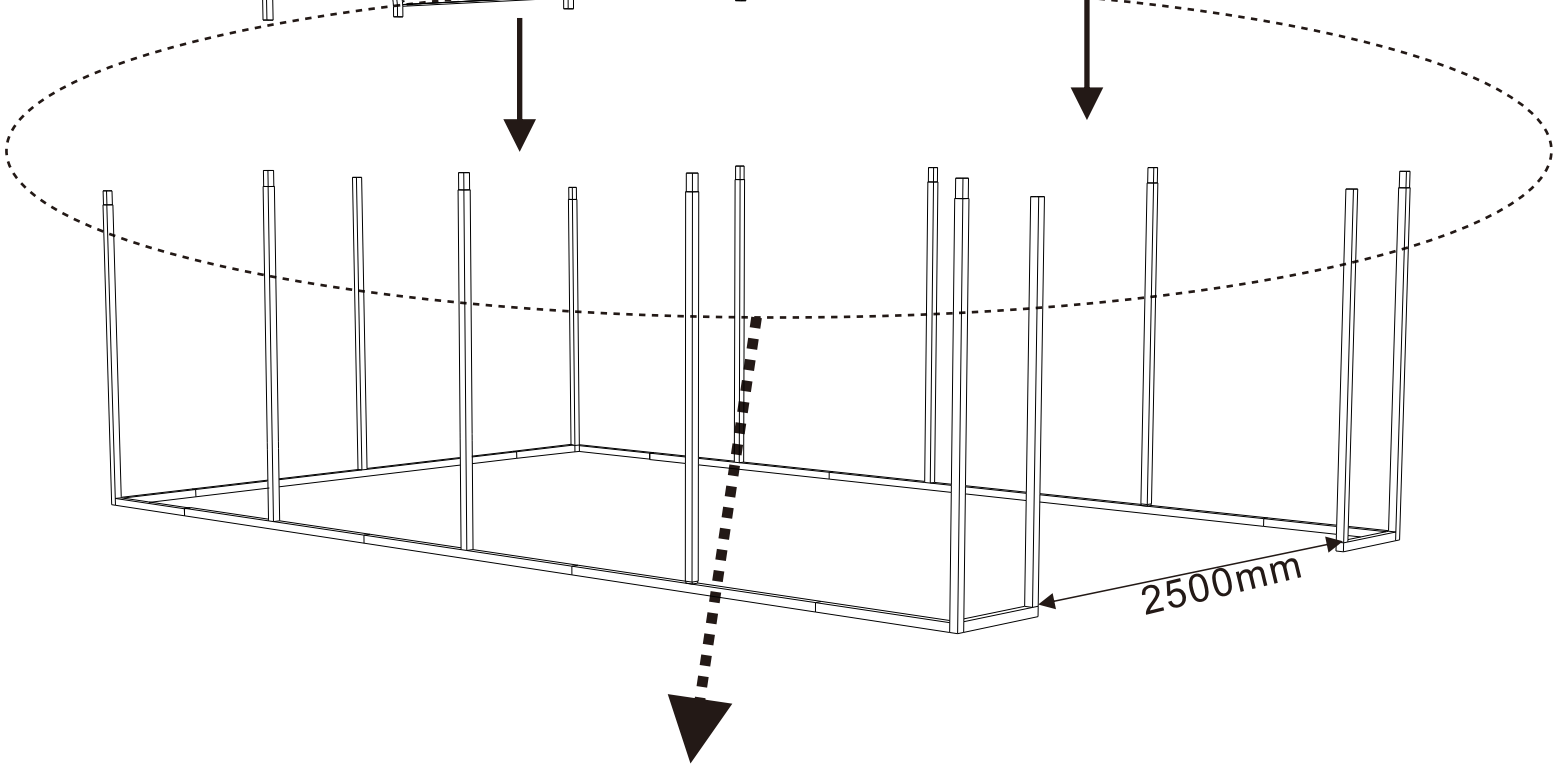
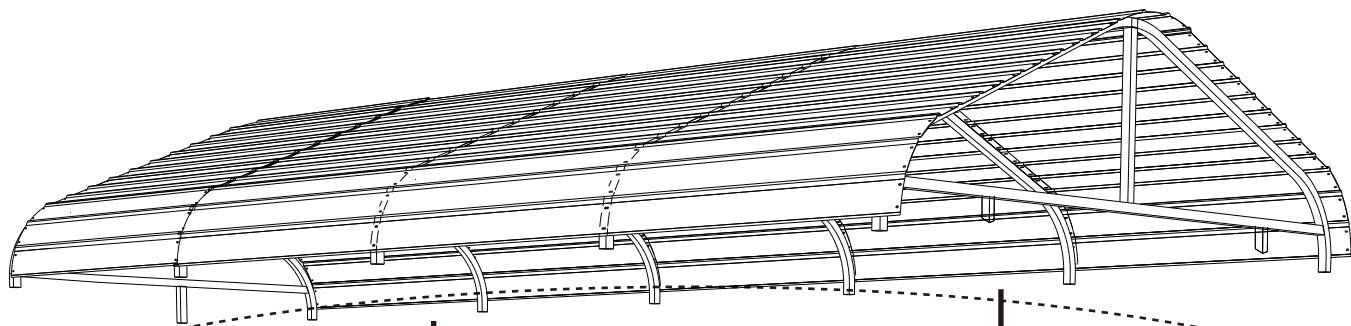

2500mm

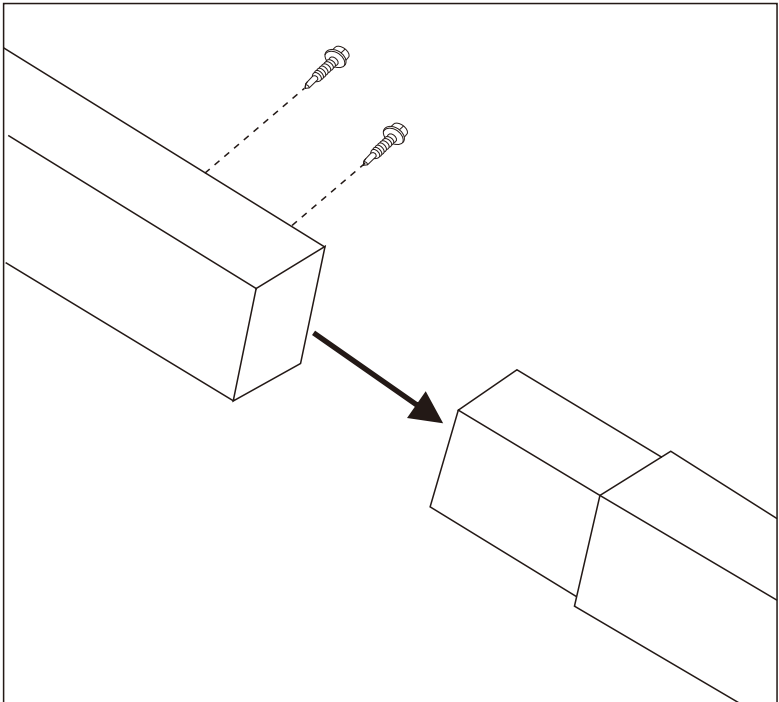

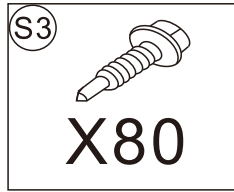
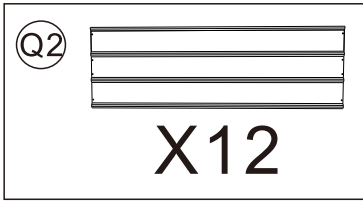

STEP-13

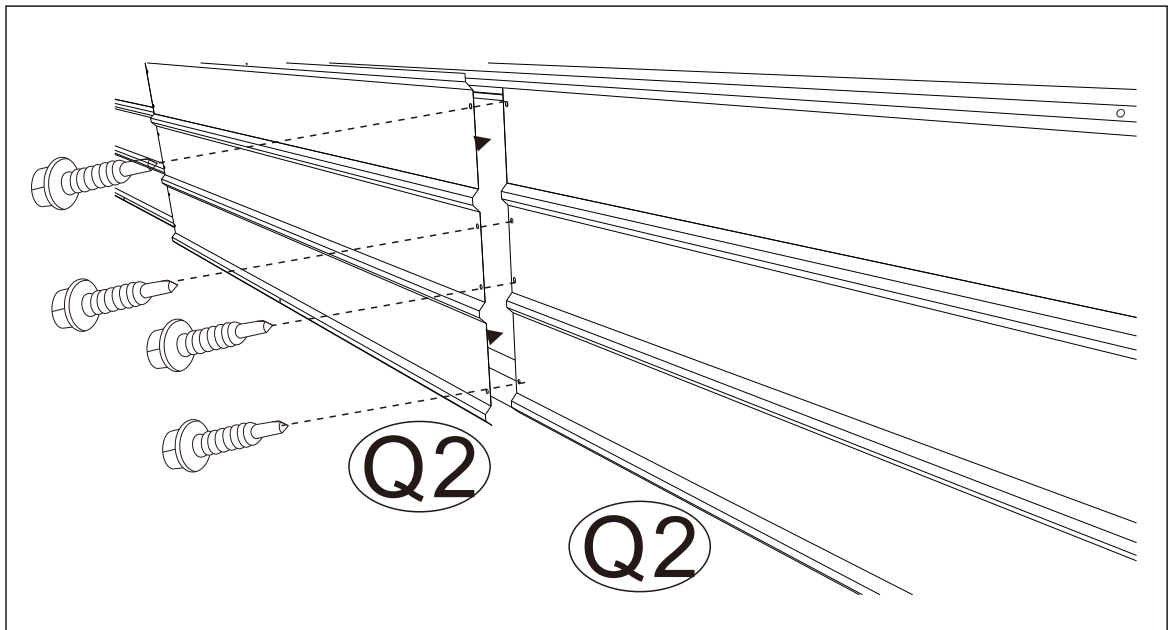
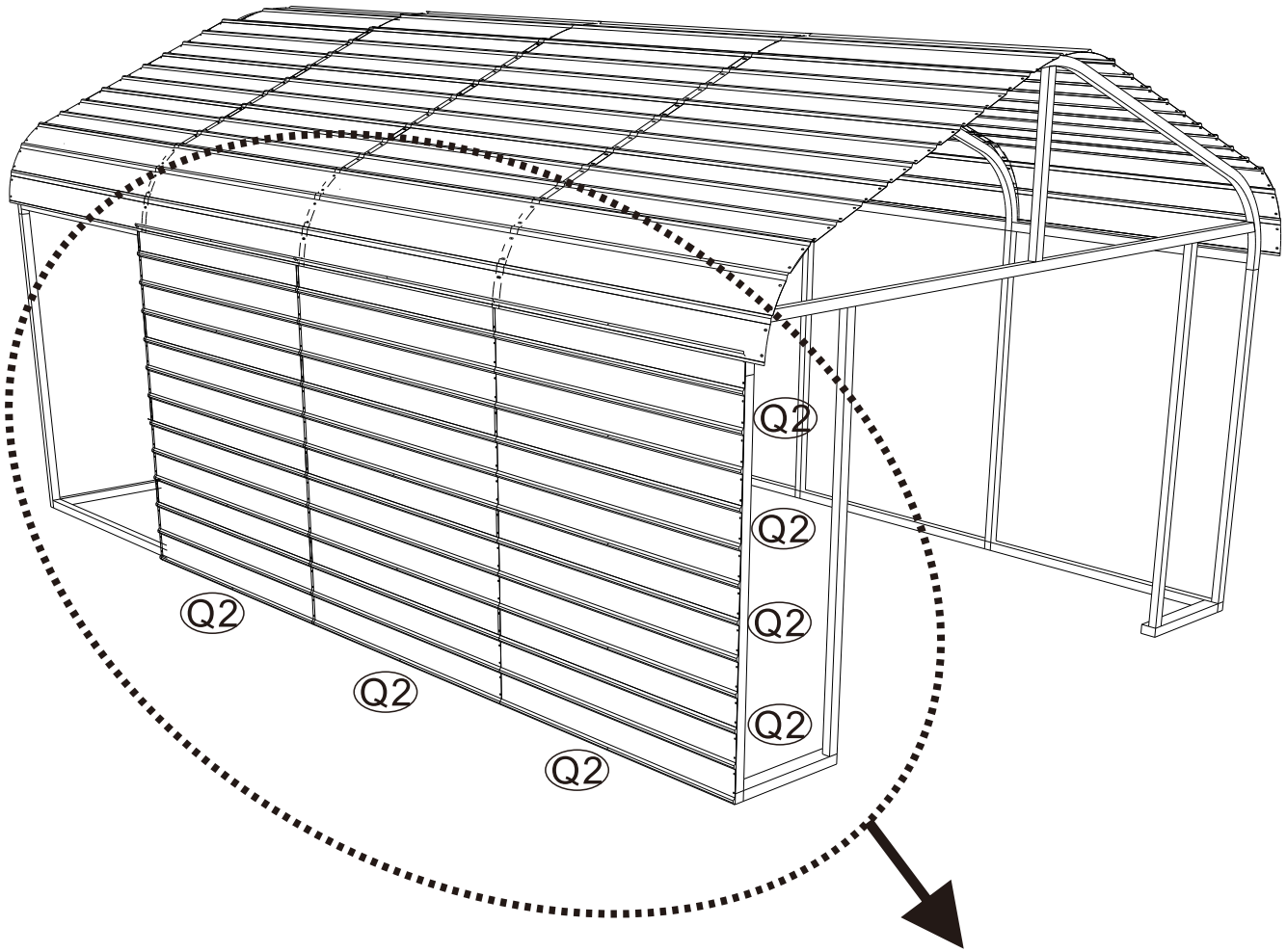

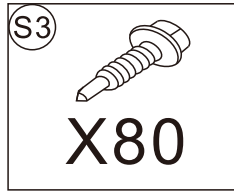
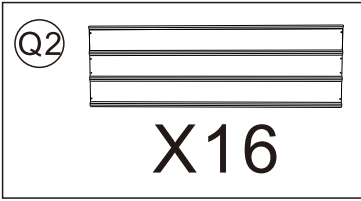

STEP-14

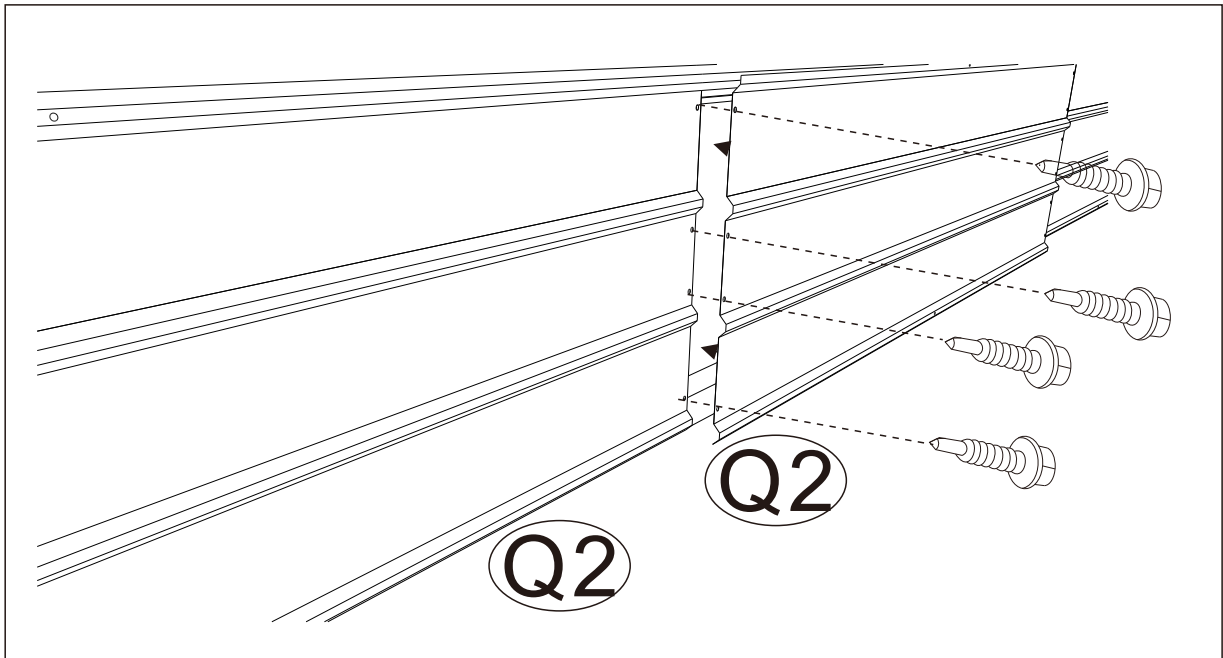
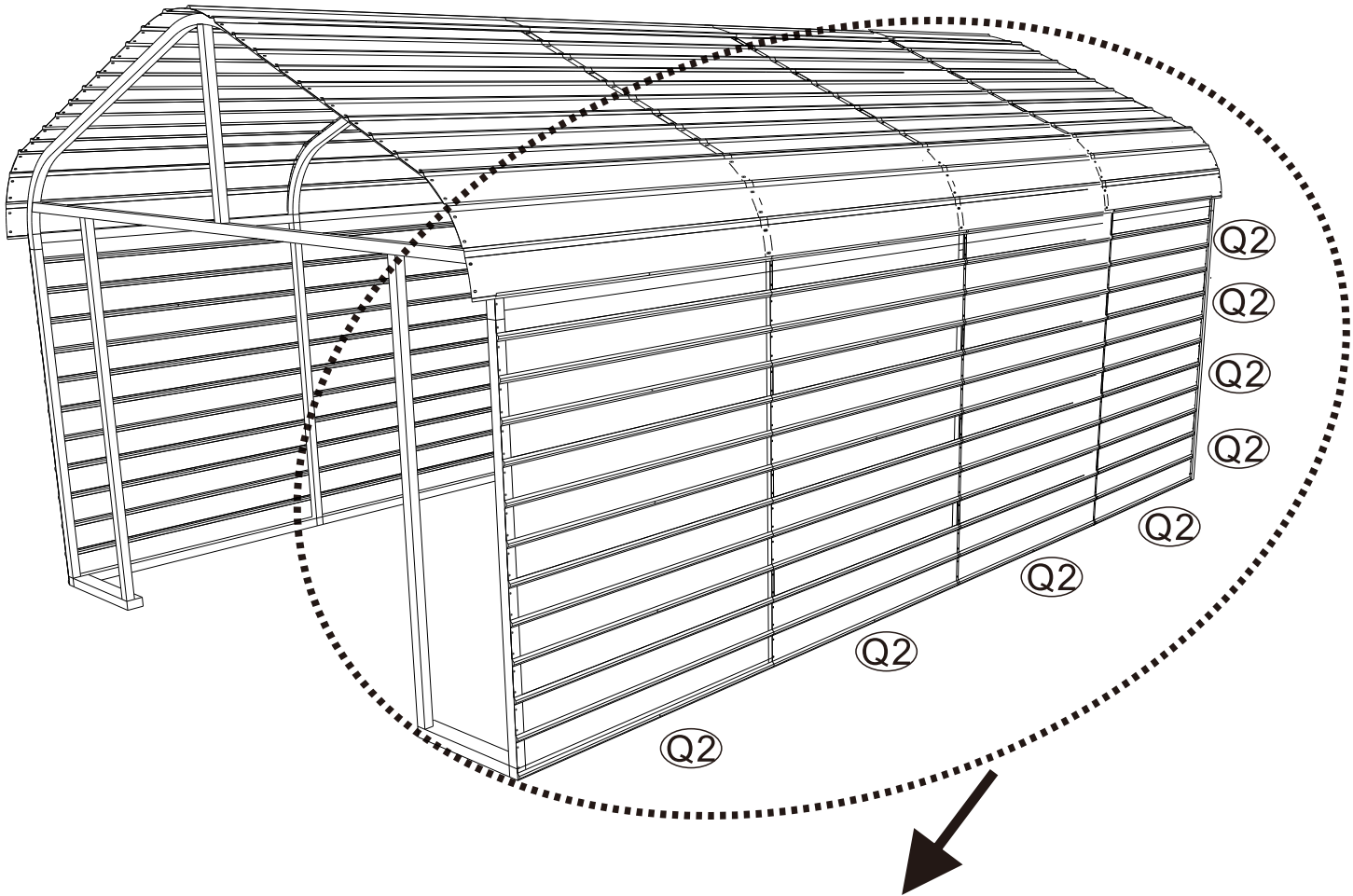

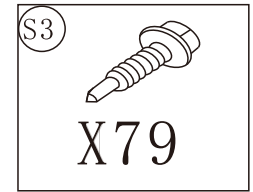
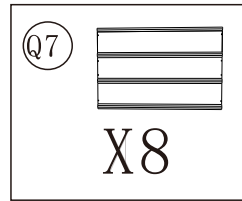
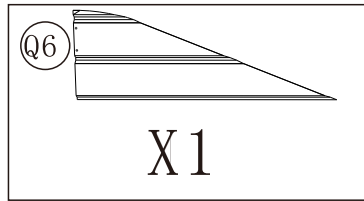
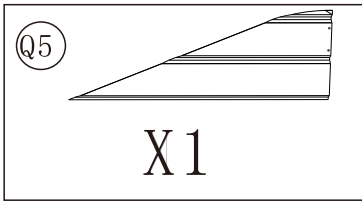
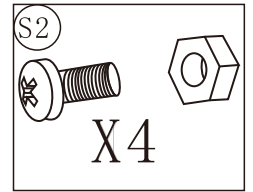
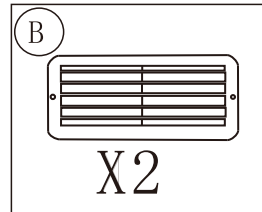
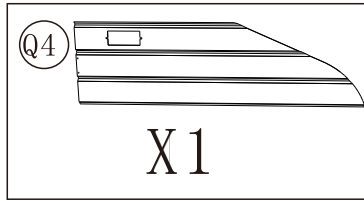
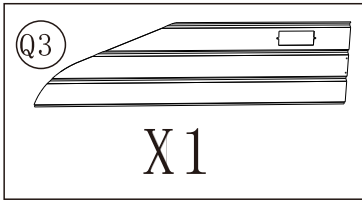

STEP-15

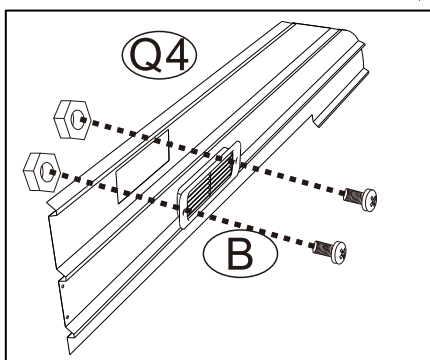
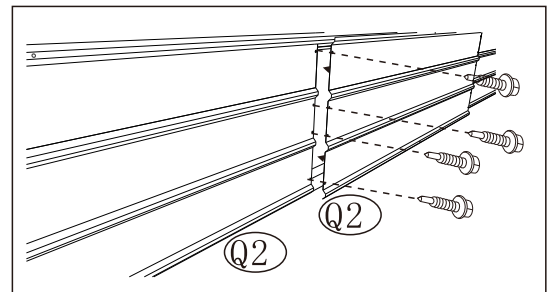
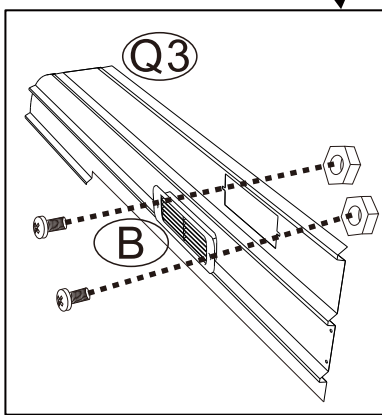
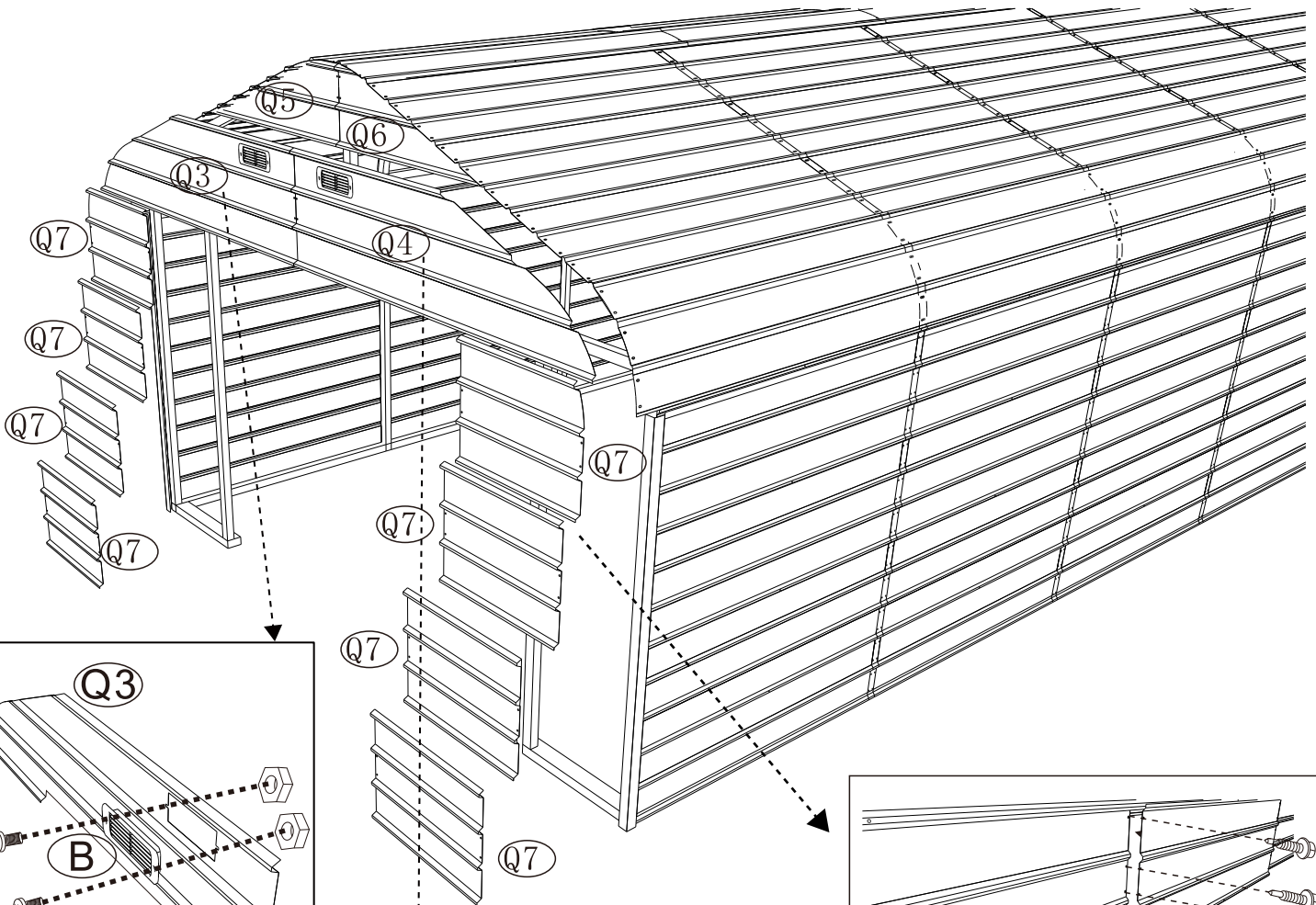

Color steel tile laying to a direction, then and drainage

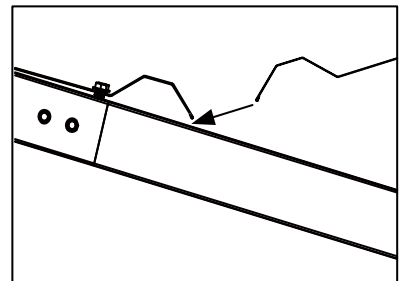
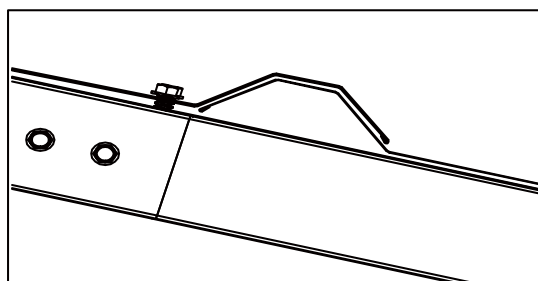

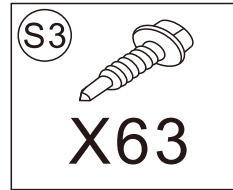
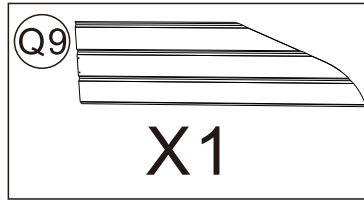
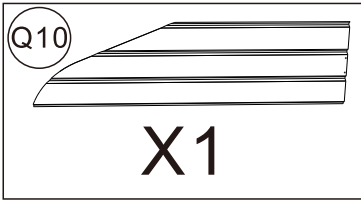
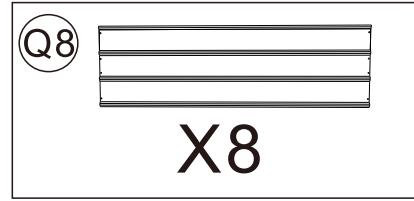
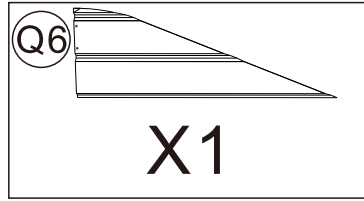
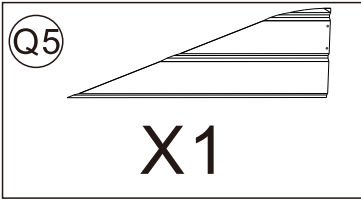

STEP-16

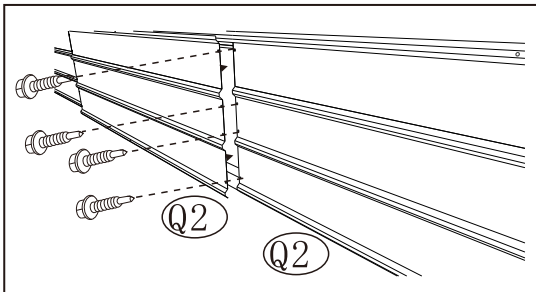
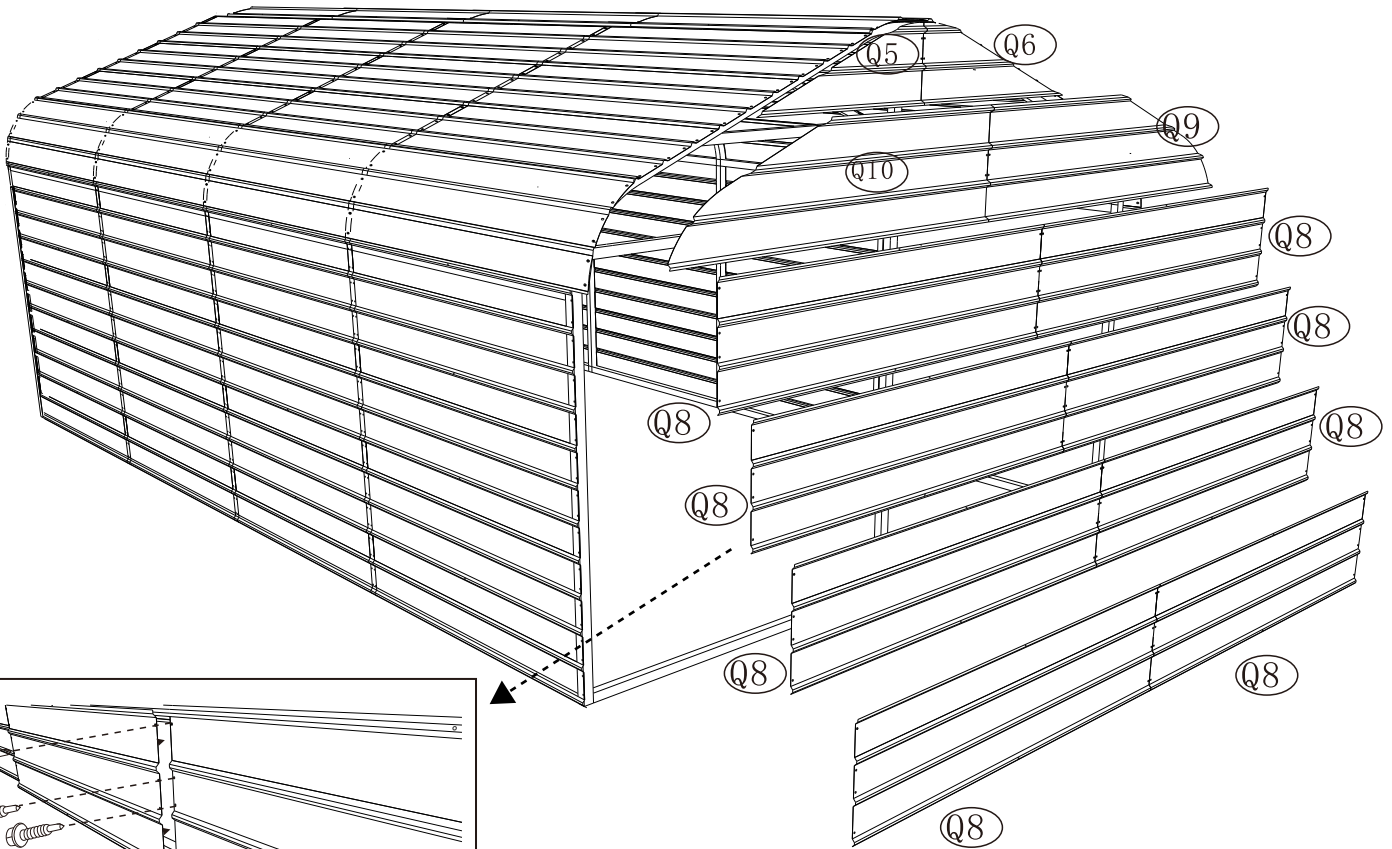

Color steel tile laying to a direction, then and drainage

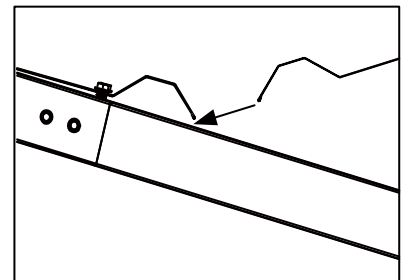
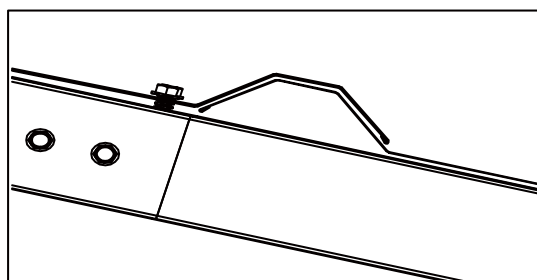

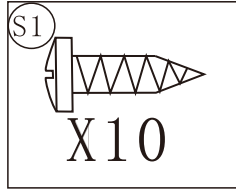
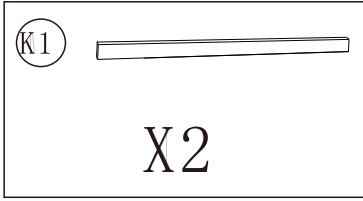

STEP-17

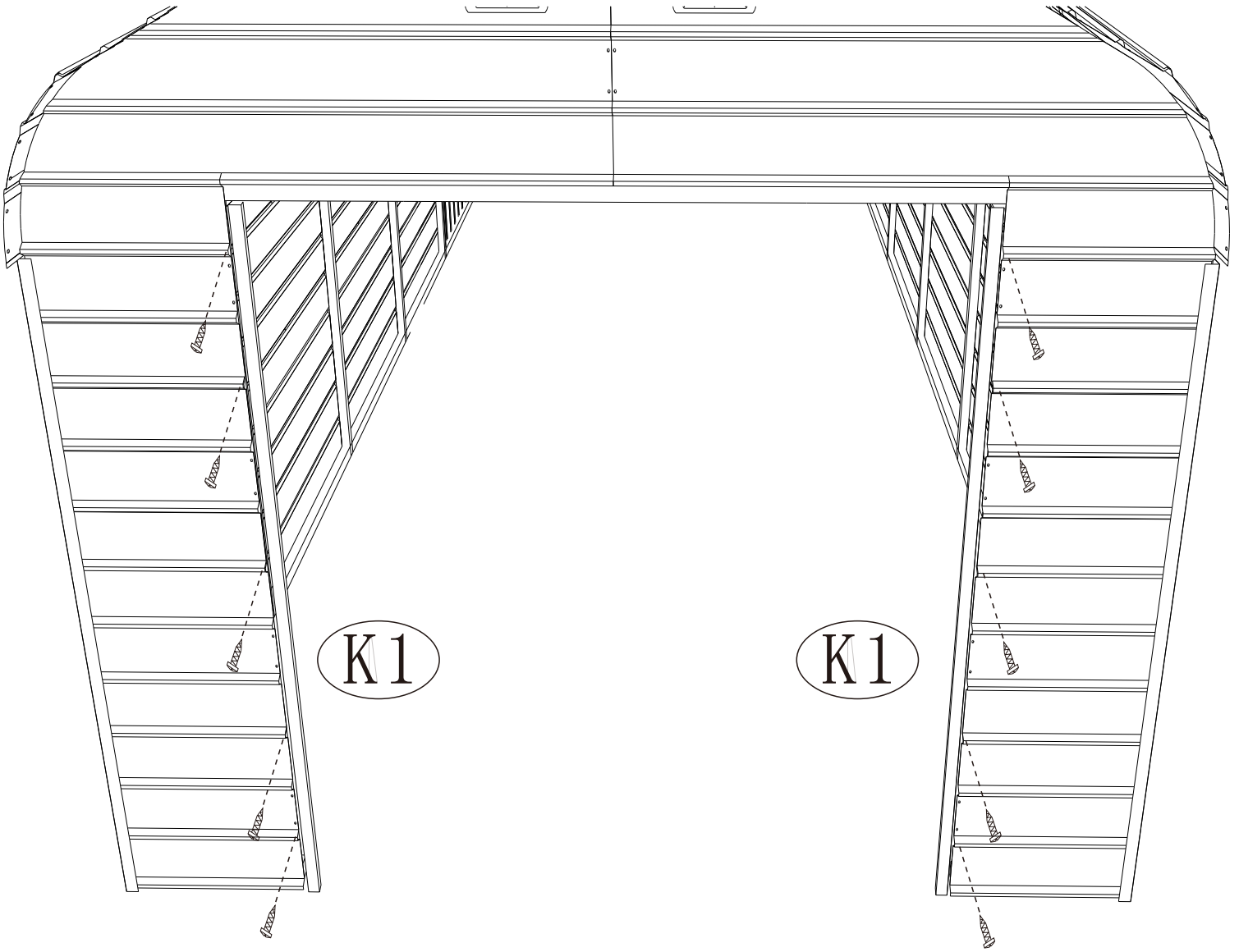

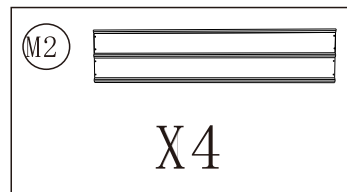
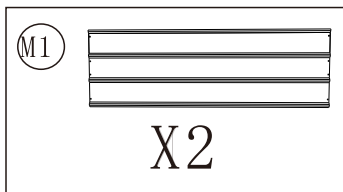
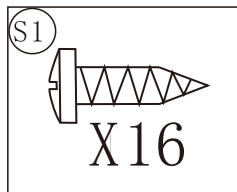
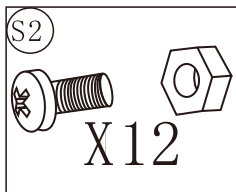
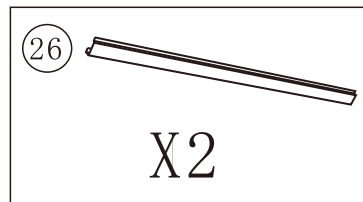
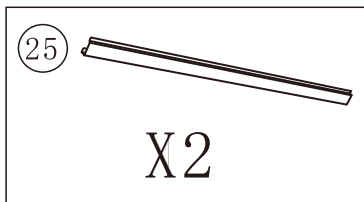
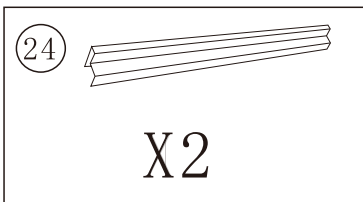

STEP-18 Install the main gate and its frame assembly

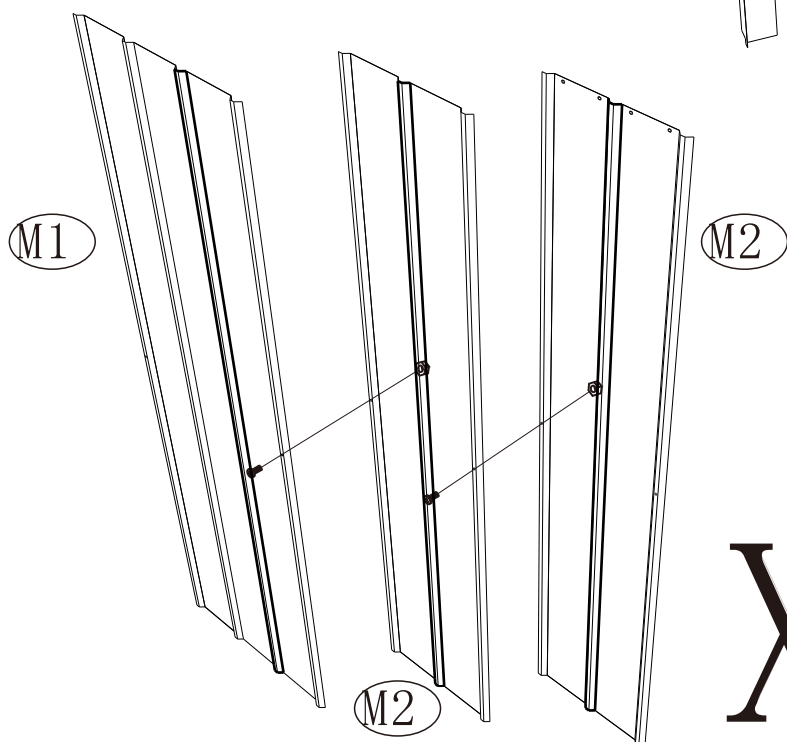
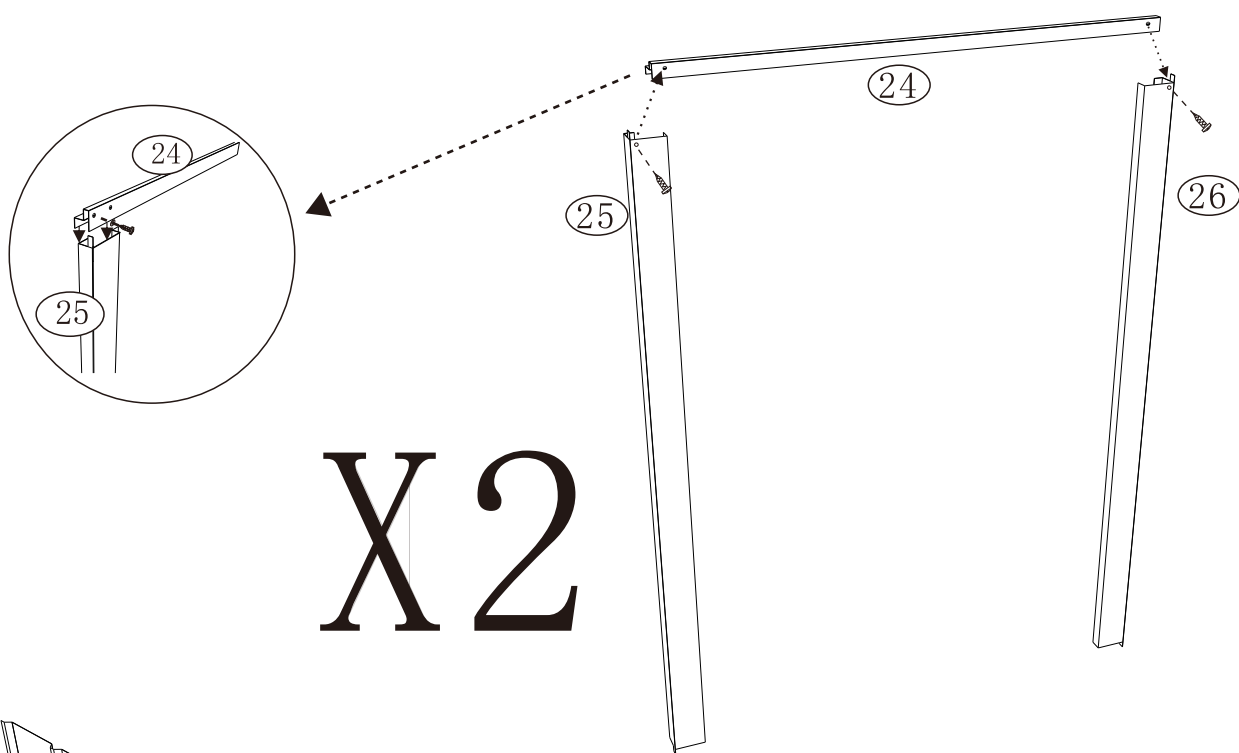

Overlap color steel sheets according to markings

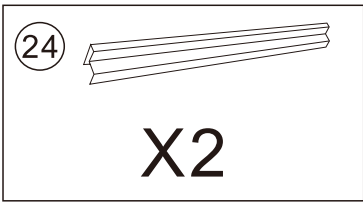

STEP-19

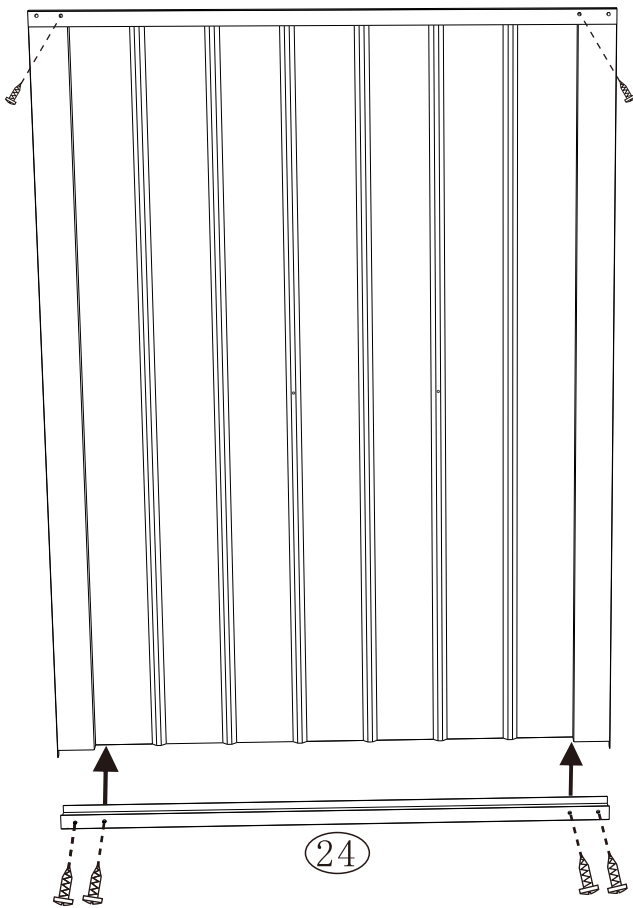
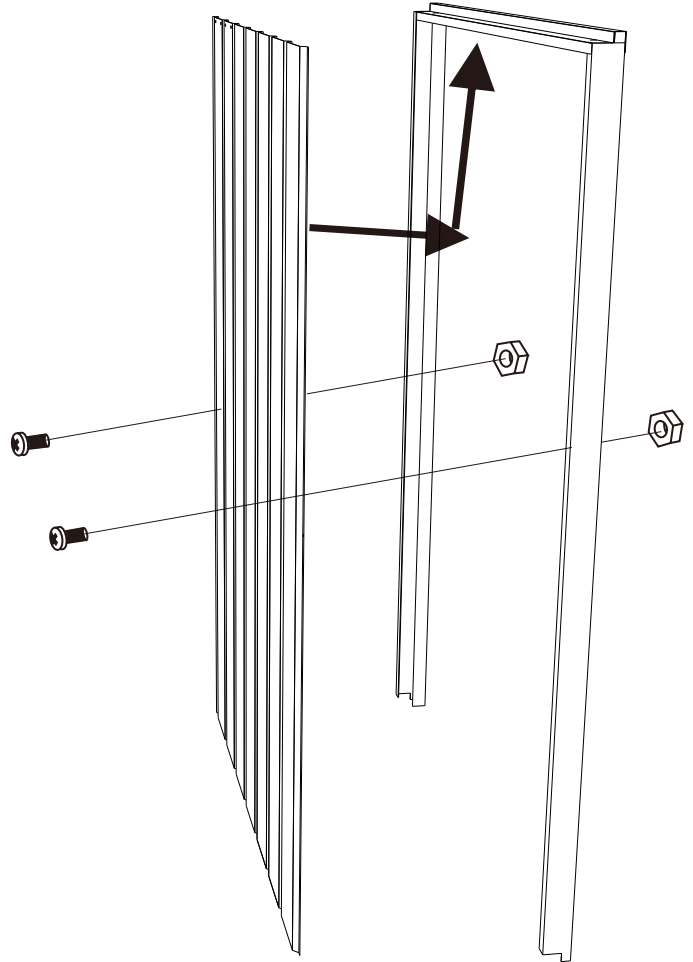

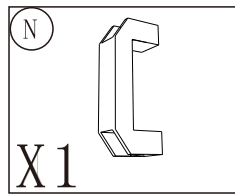
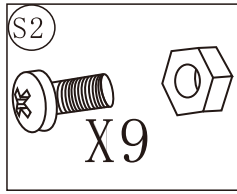
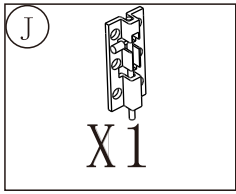
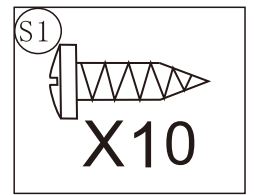
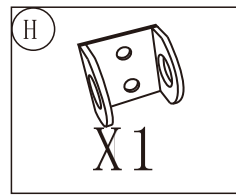
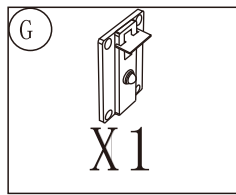
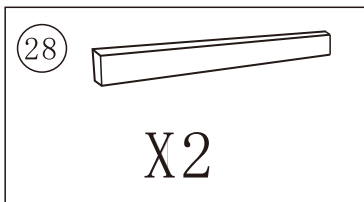

STEP-20

Back side of the door

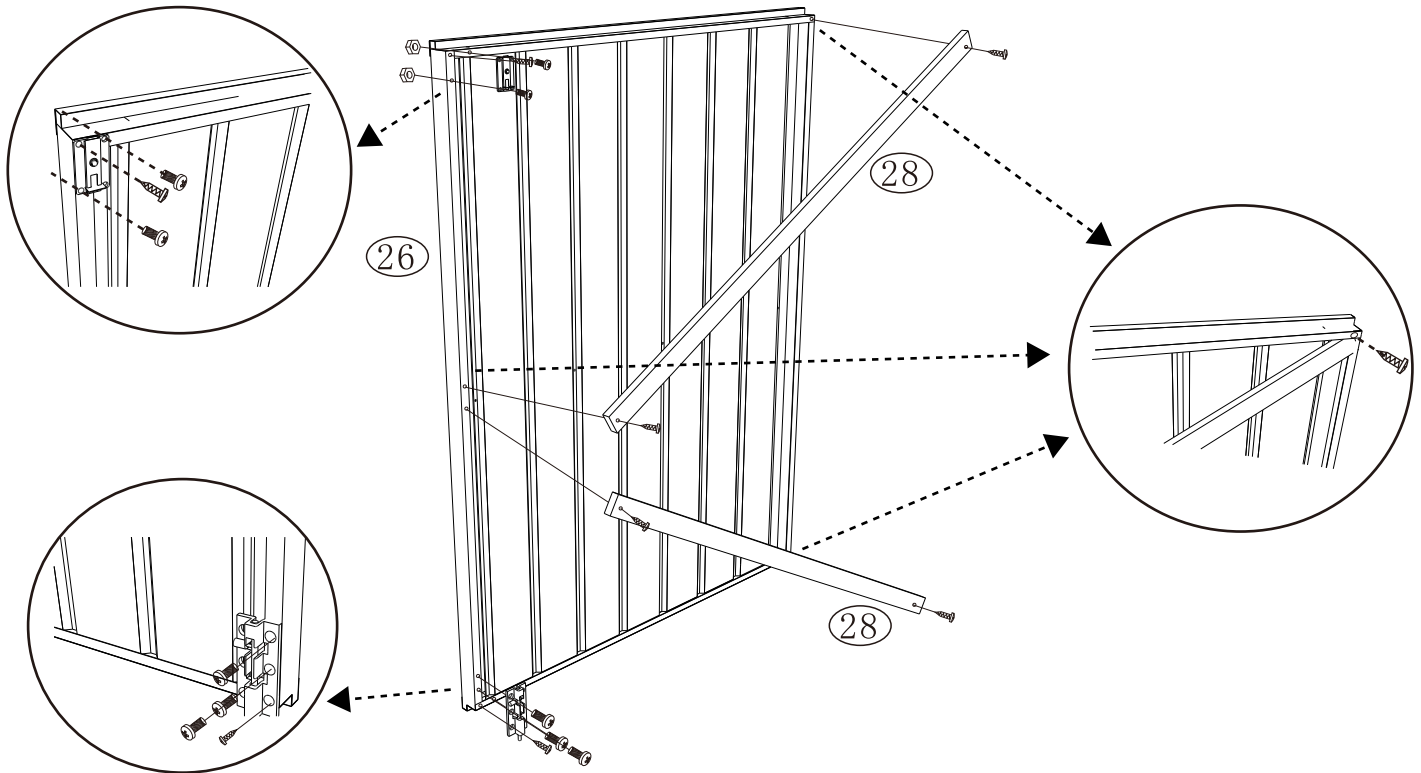

Front side of the door

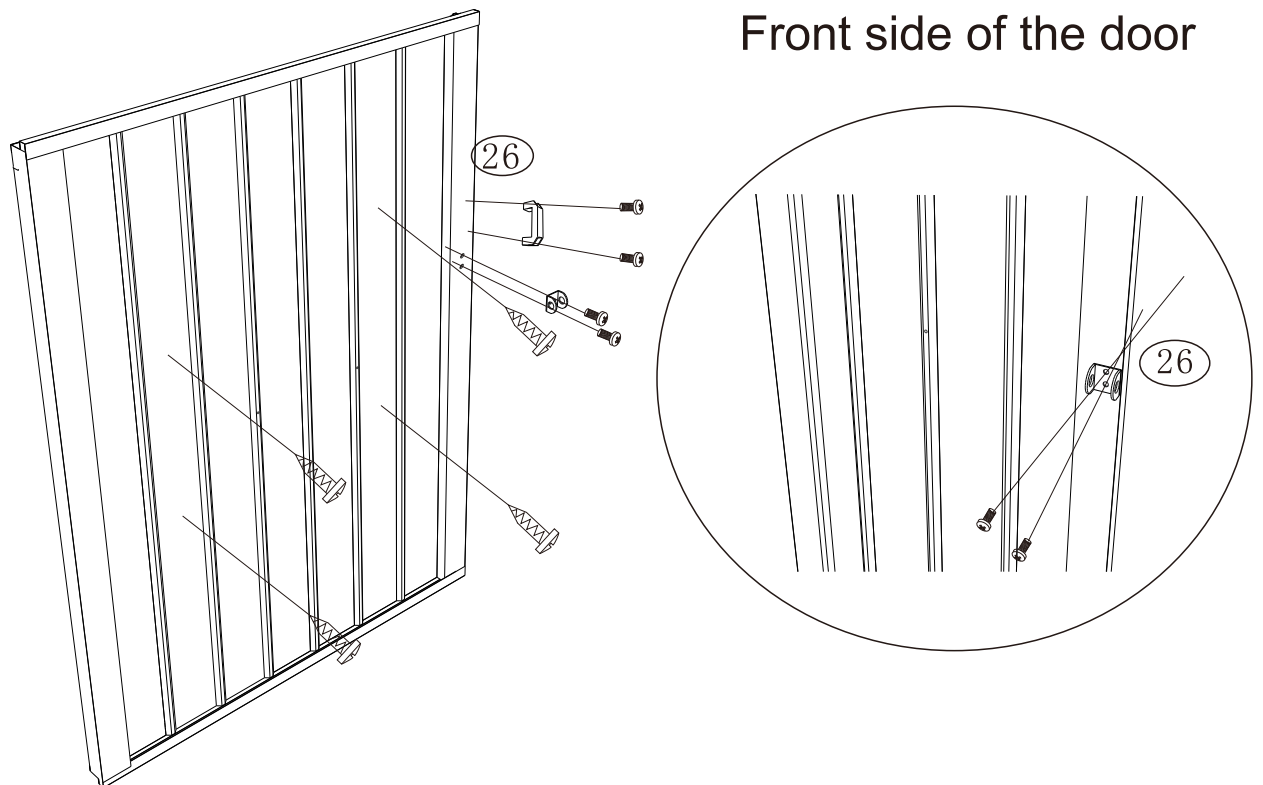

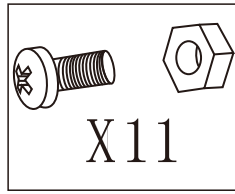
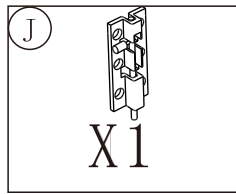
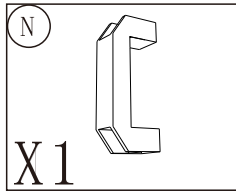
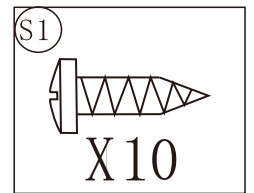
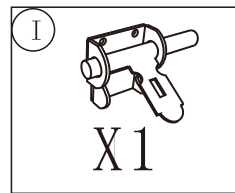
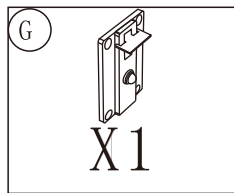
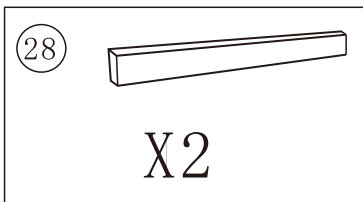

STEP-21

The opposite door panel

Back side of the door

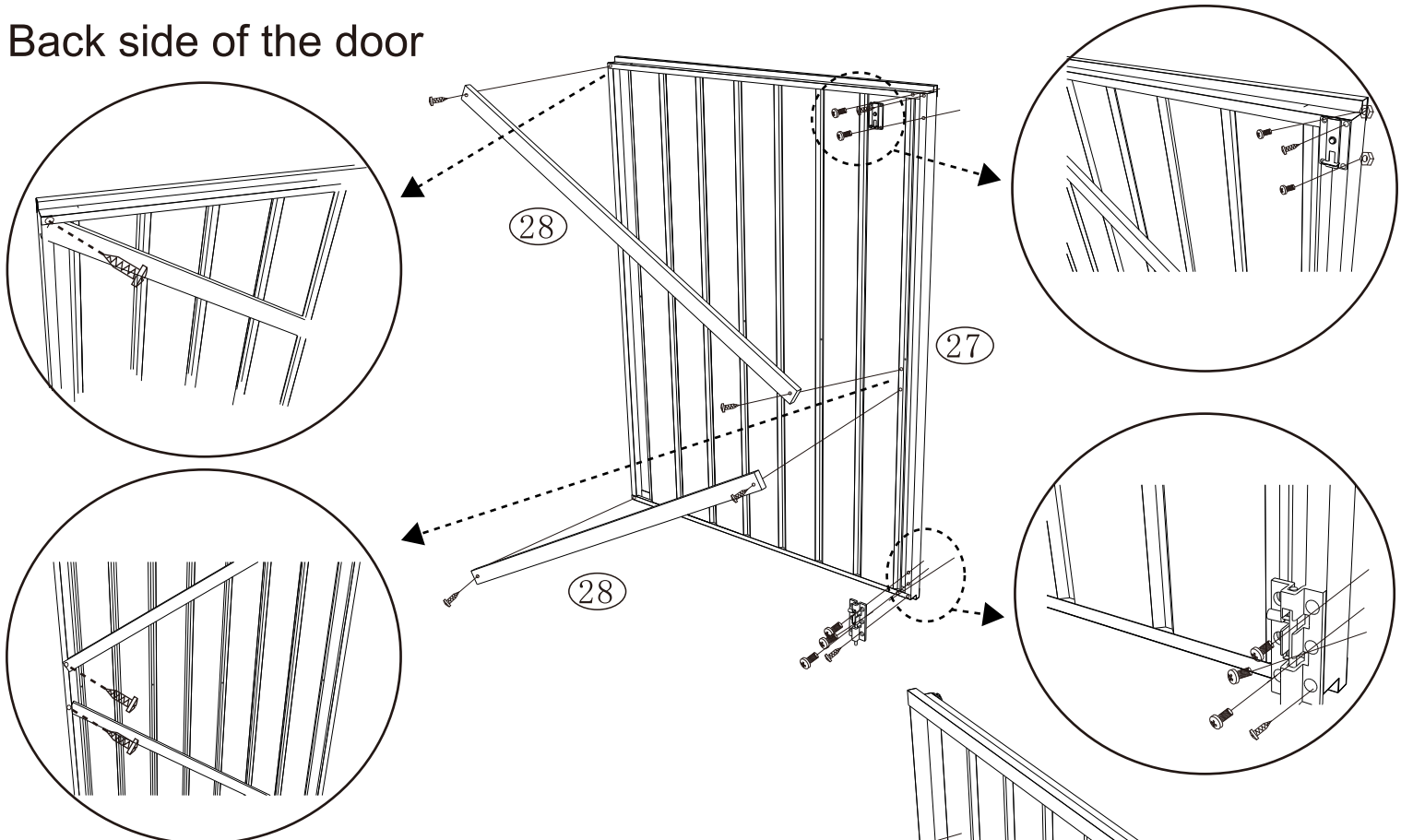

Front side of the door

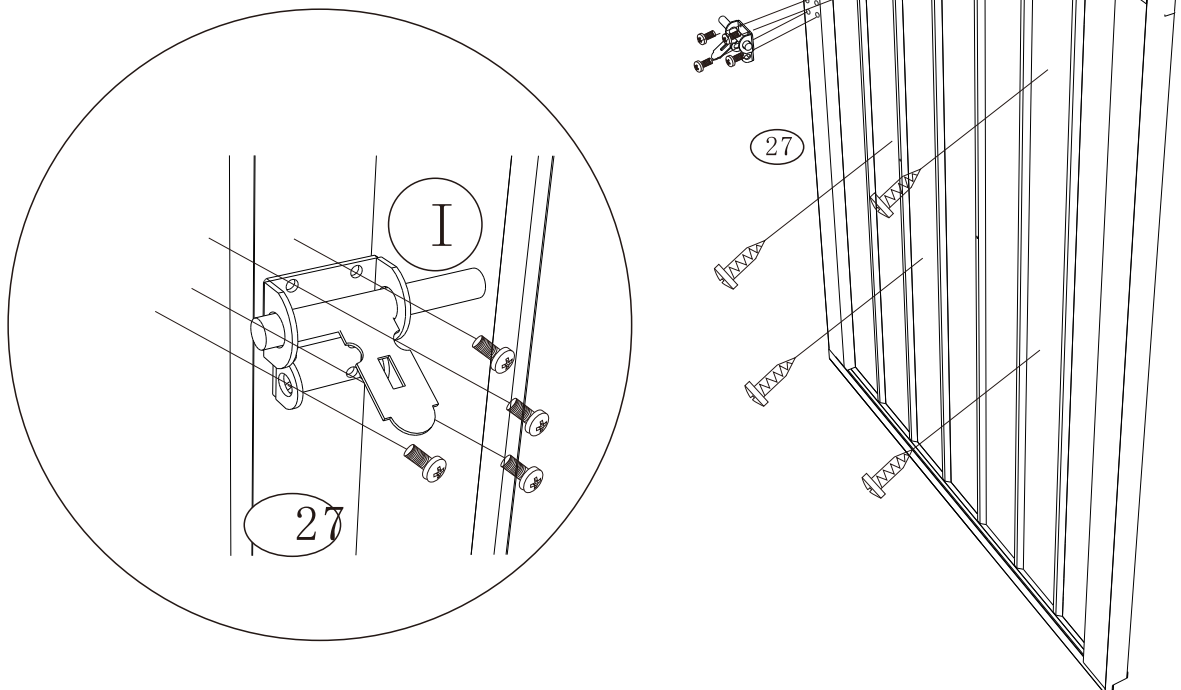

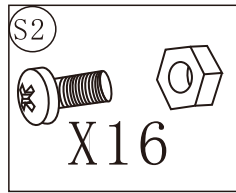
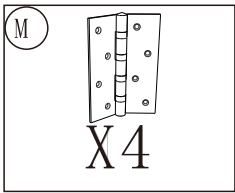

STEP-22

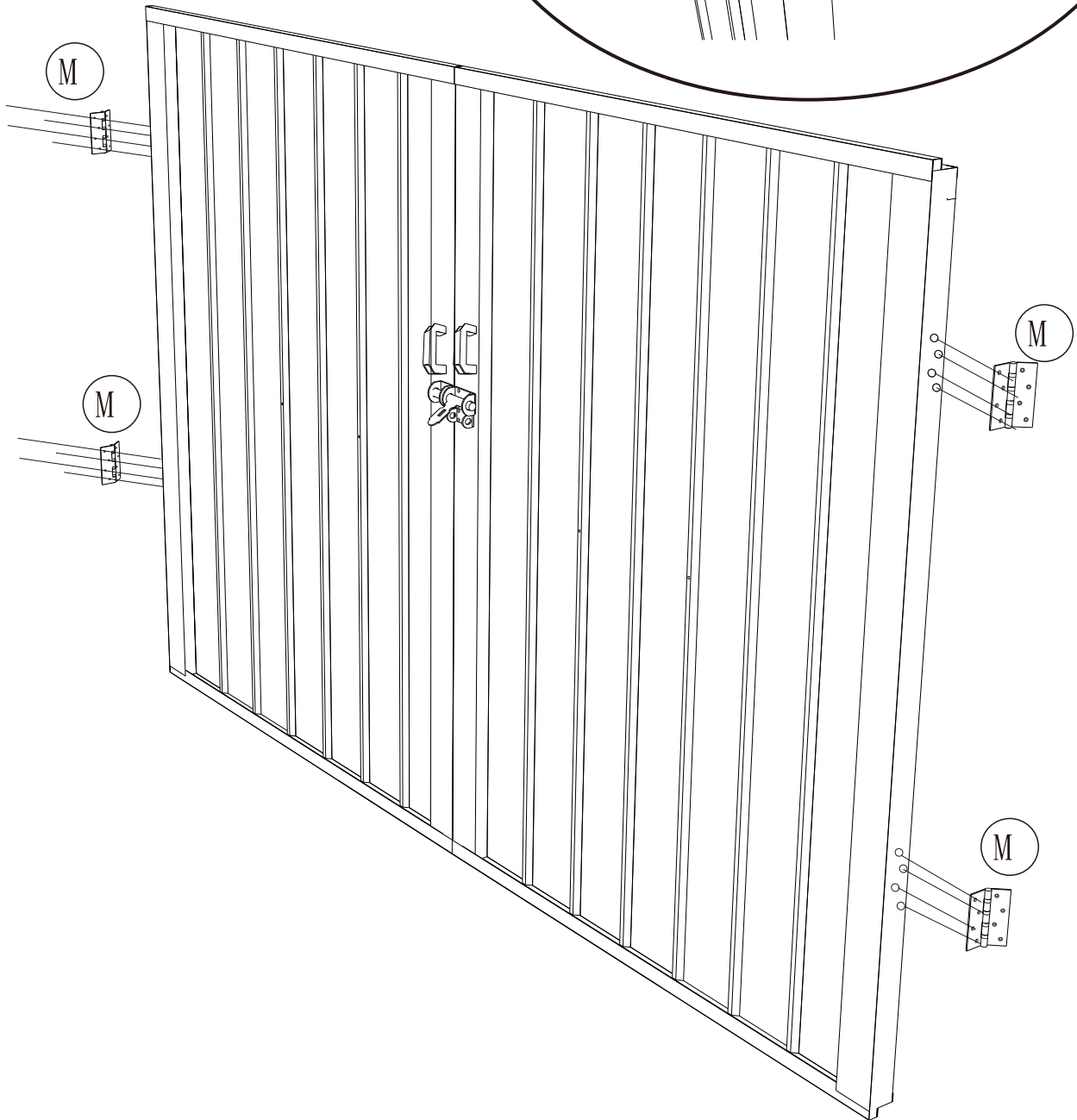
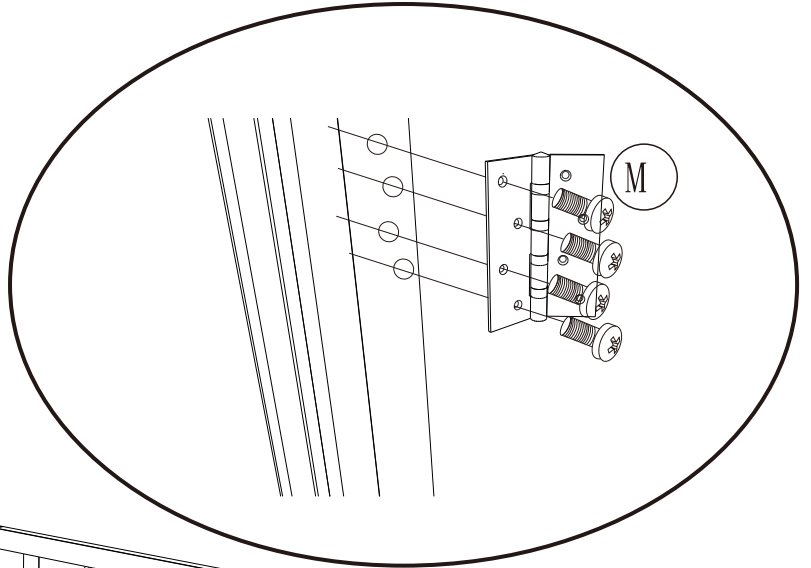

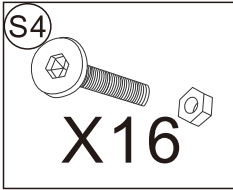

STEP-23

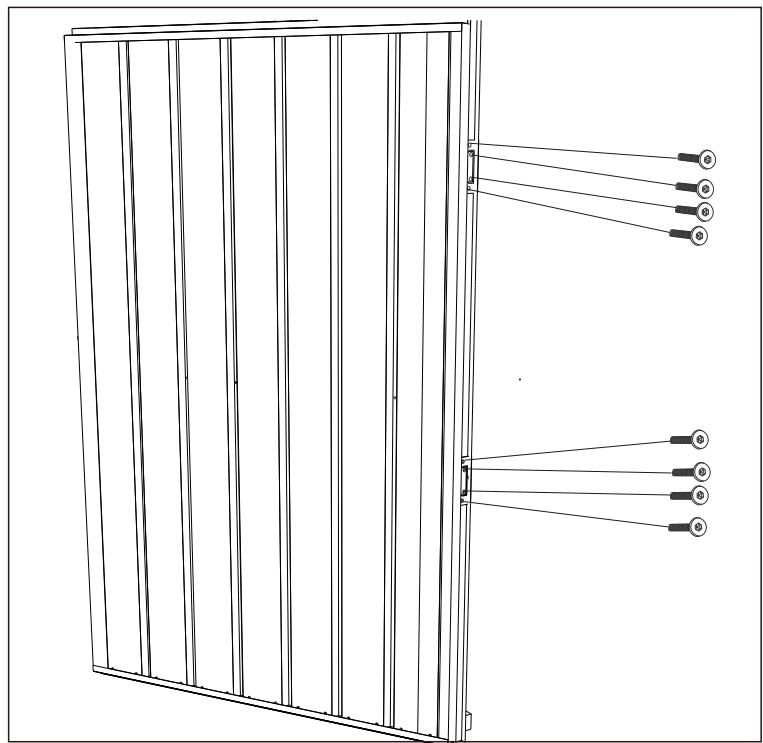
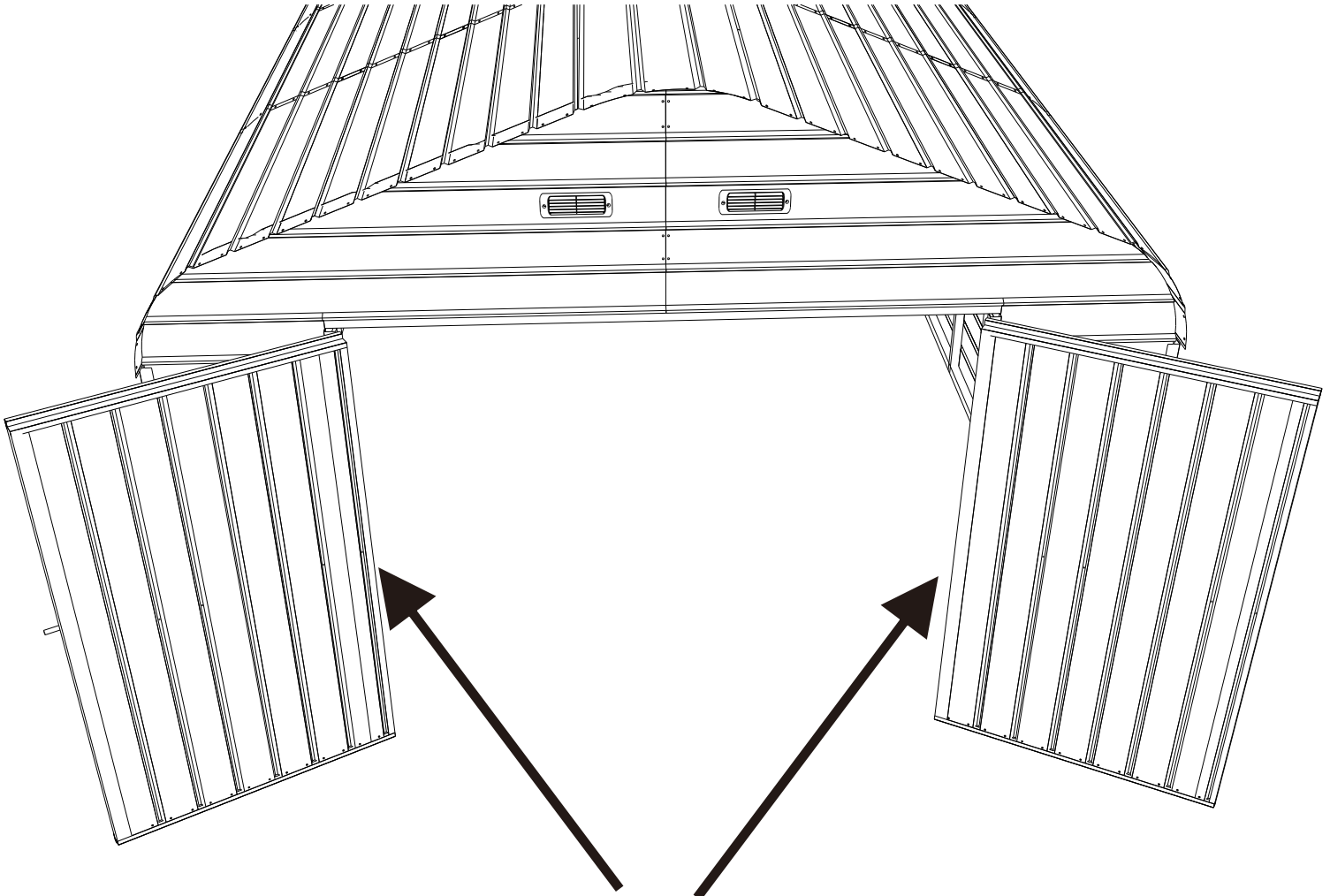

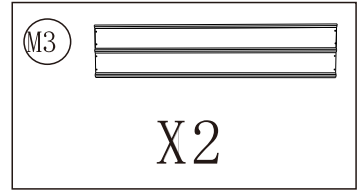
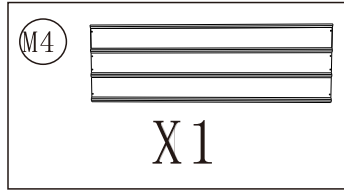
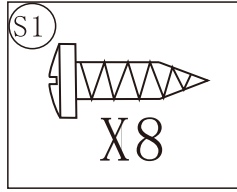
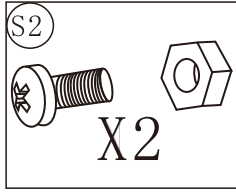
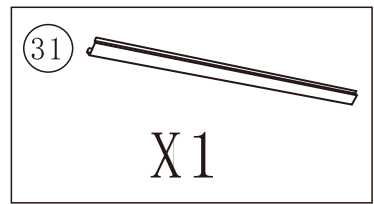
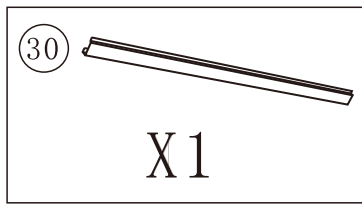
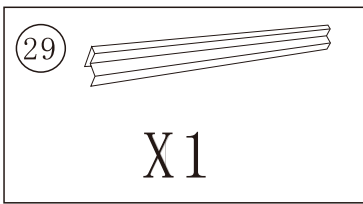

STEP-24

Install the main gate and its frame assembly

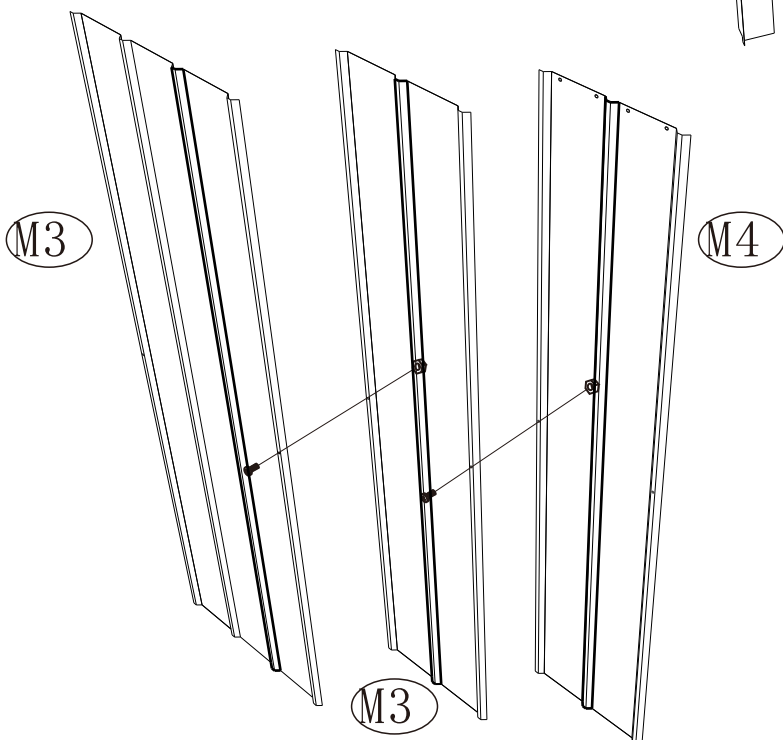
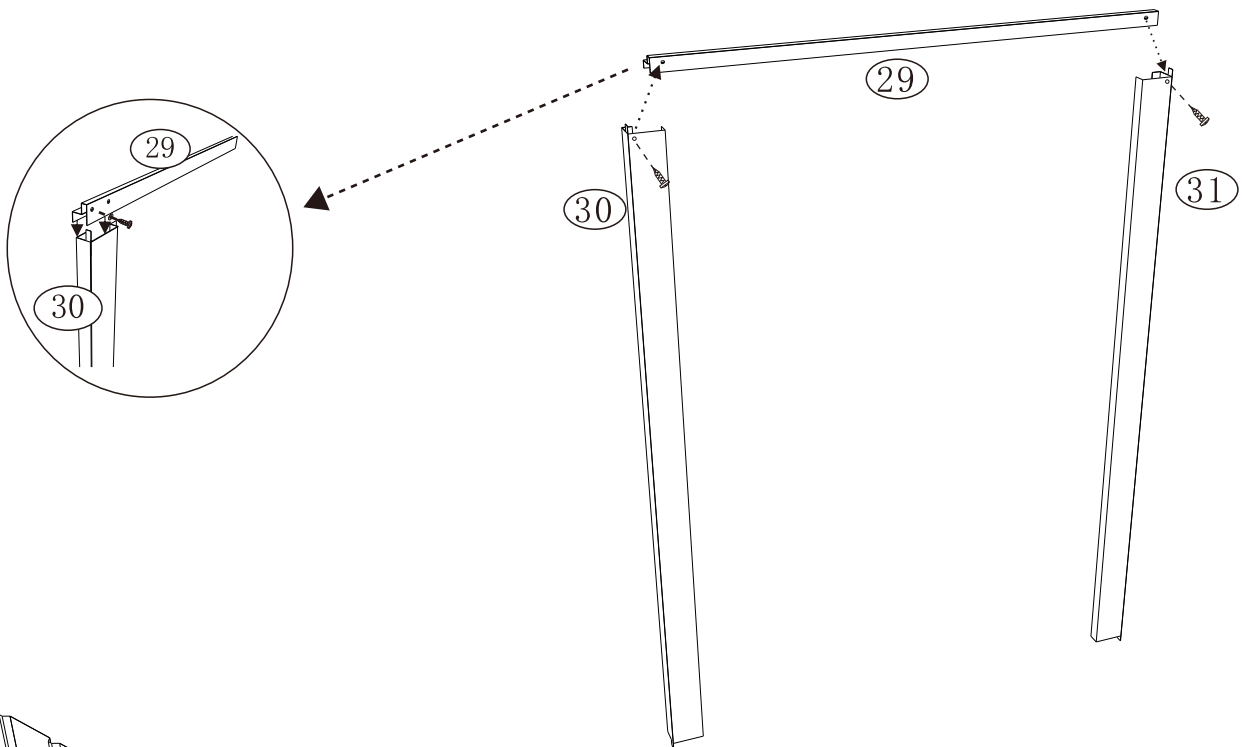

Overlap color steel sheets according to markings

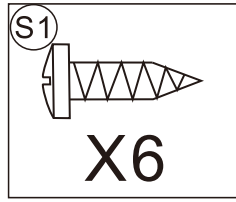
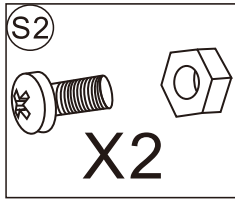
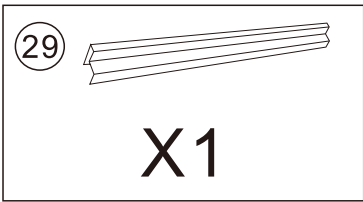

STEP-25

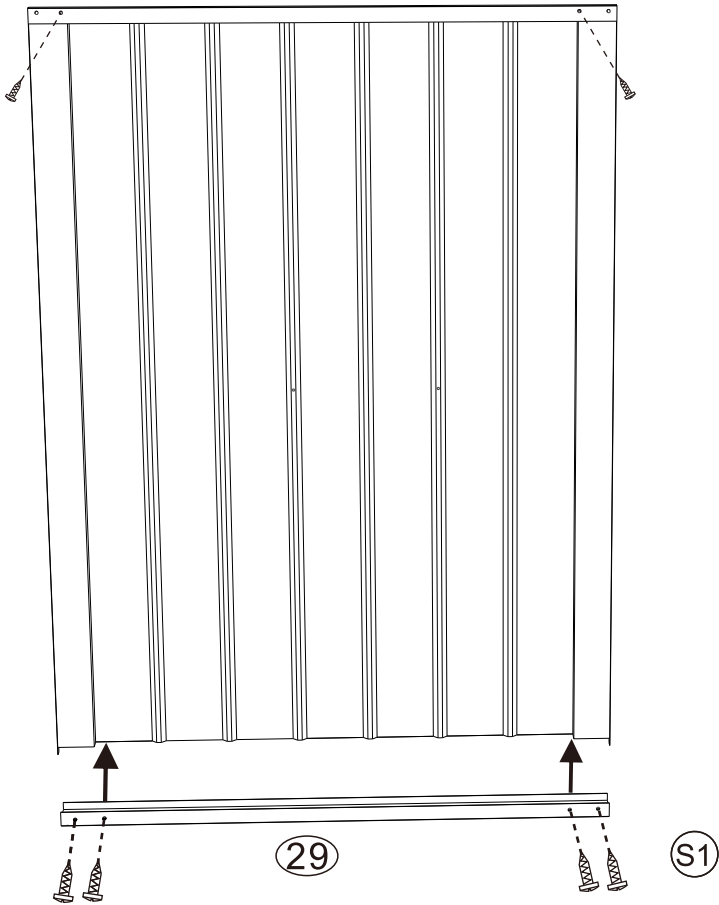
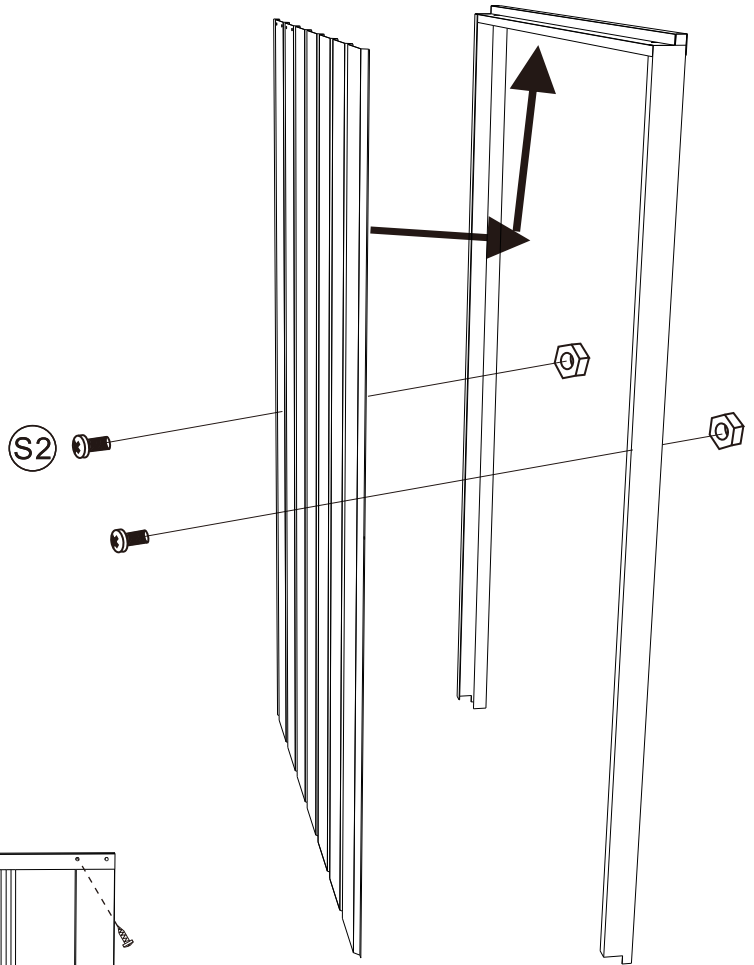

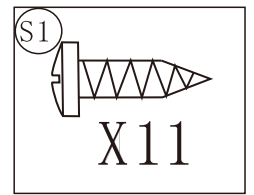
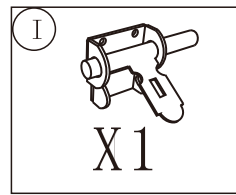
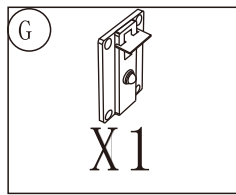
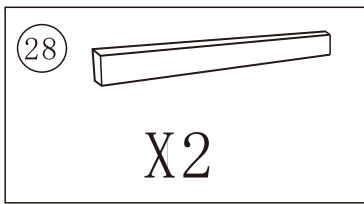

STEP-26

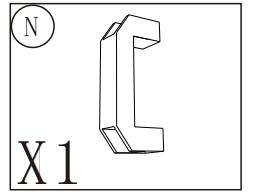
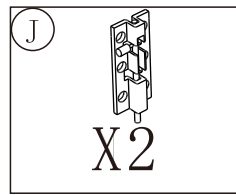
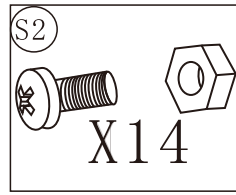

Back side of the door

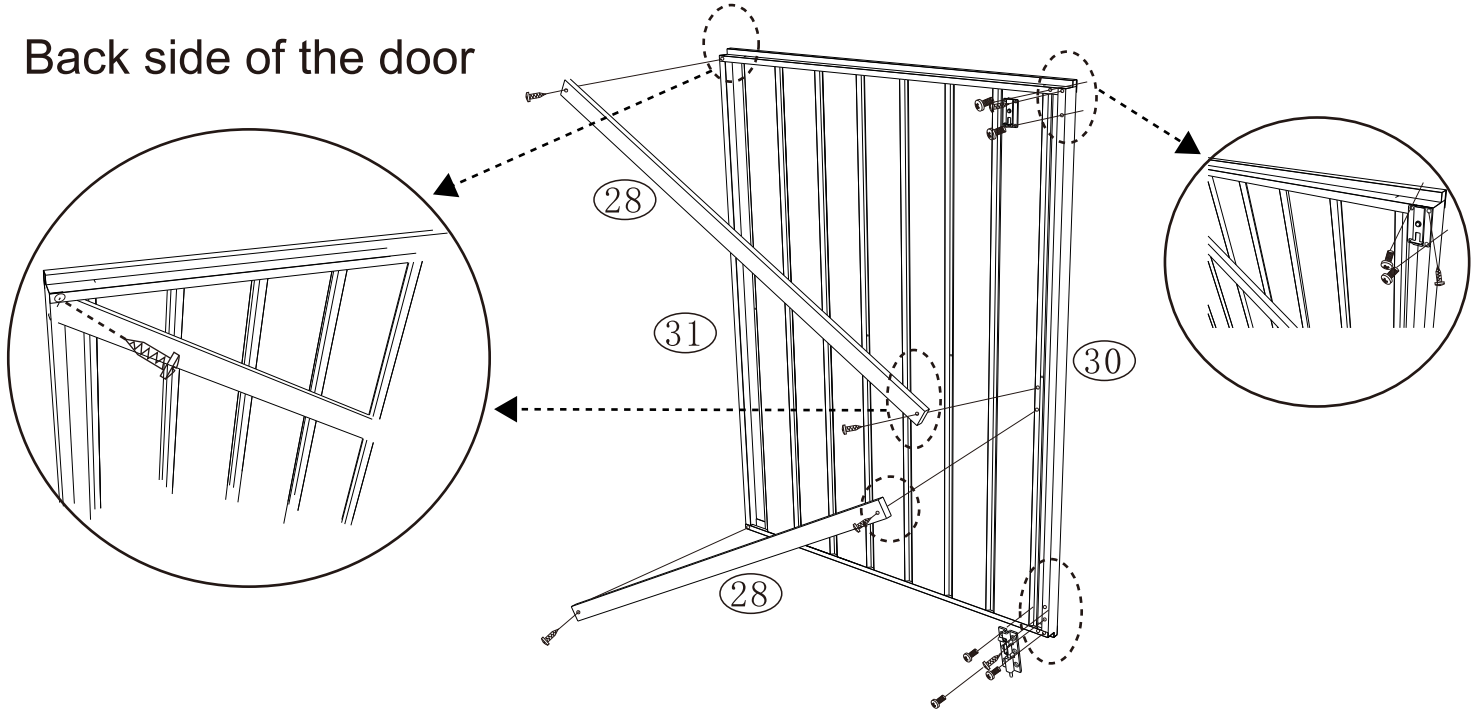

Front side of the door

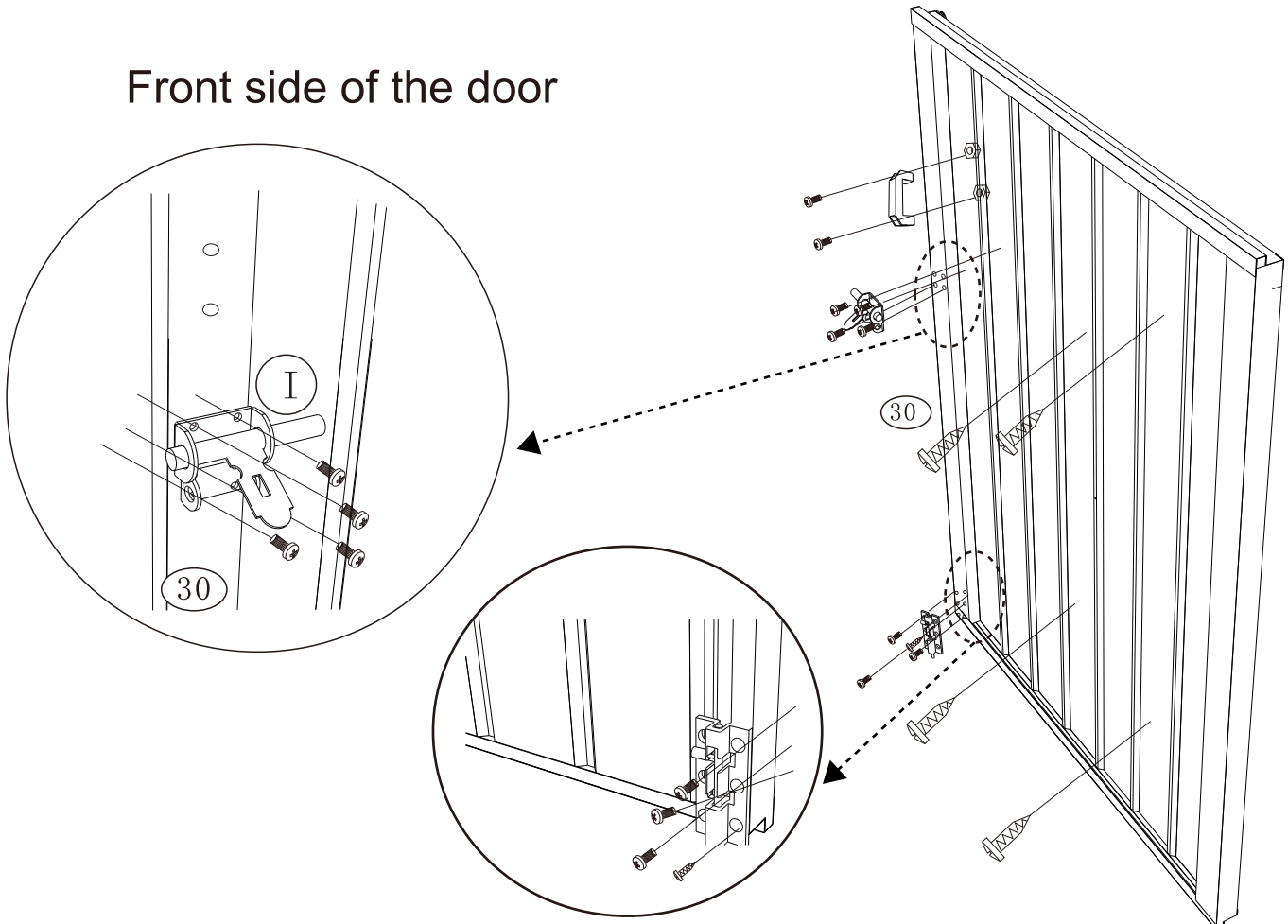

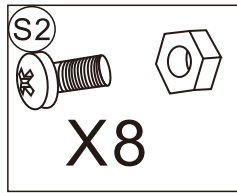
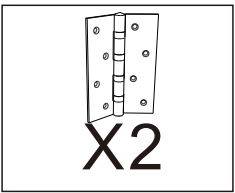

STEP-27

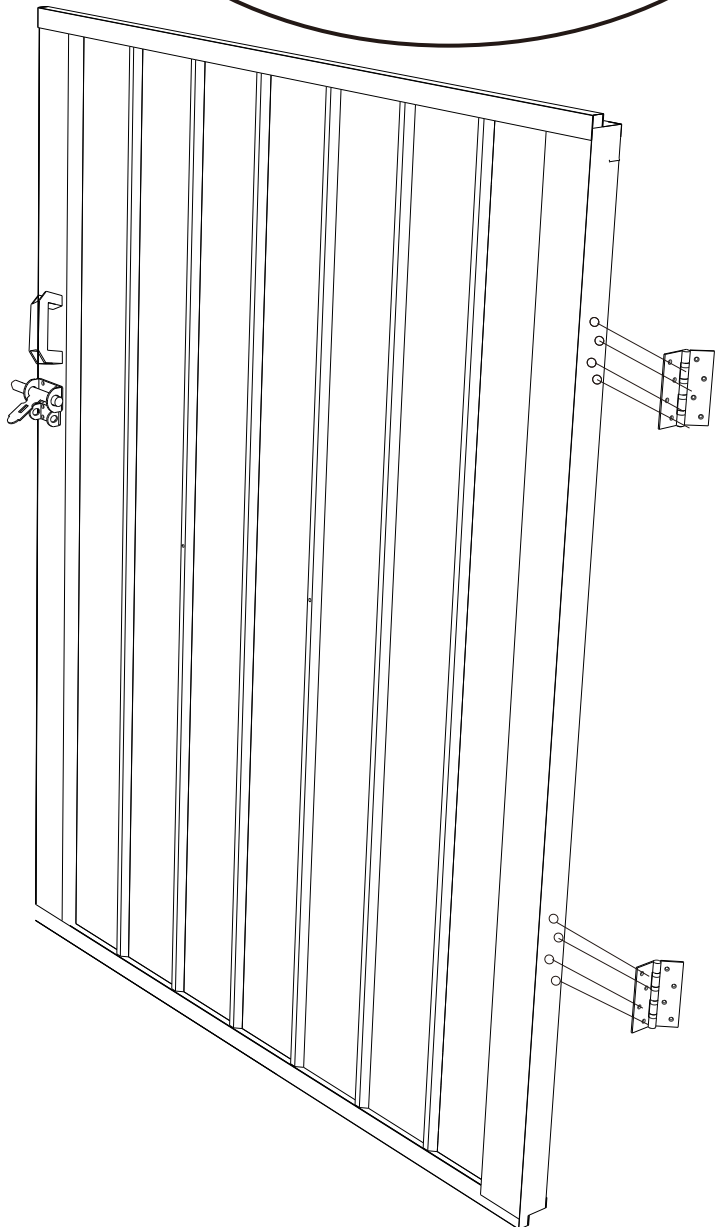
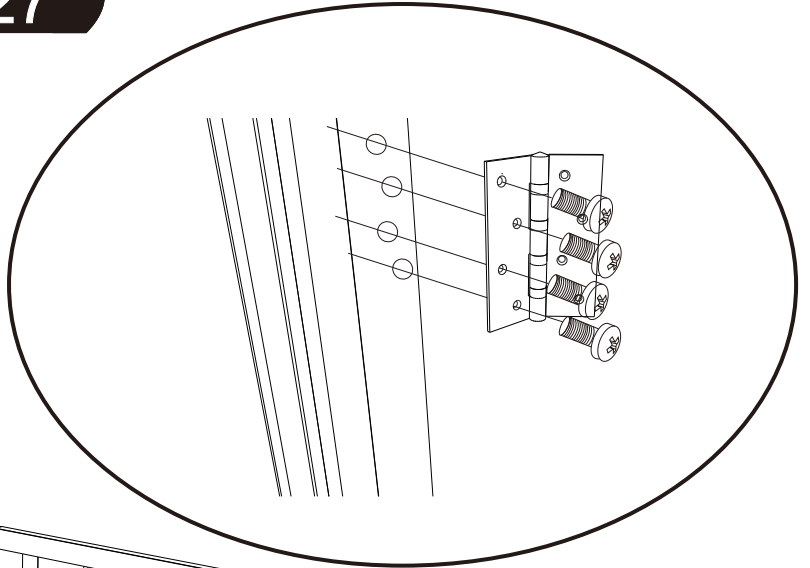

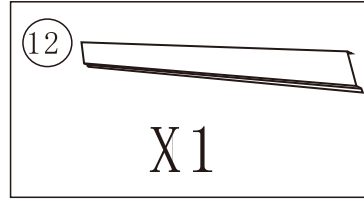
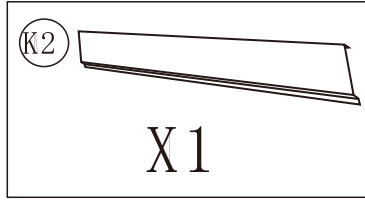
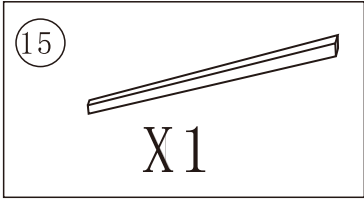

STEP-28

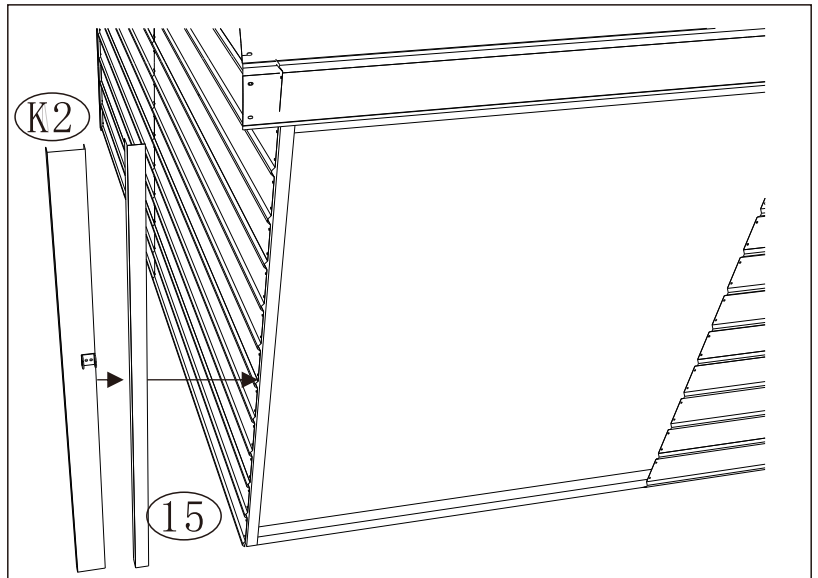
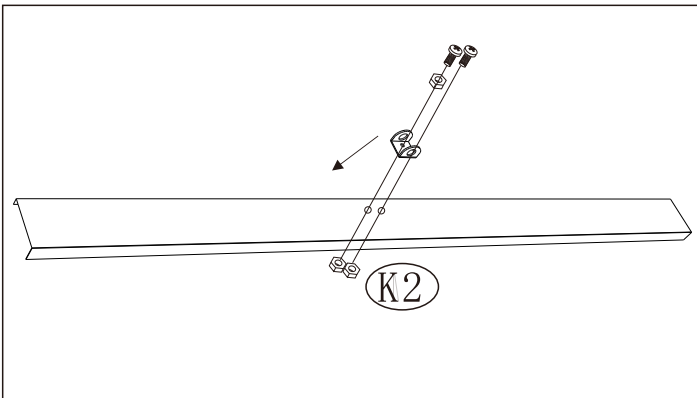
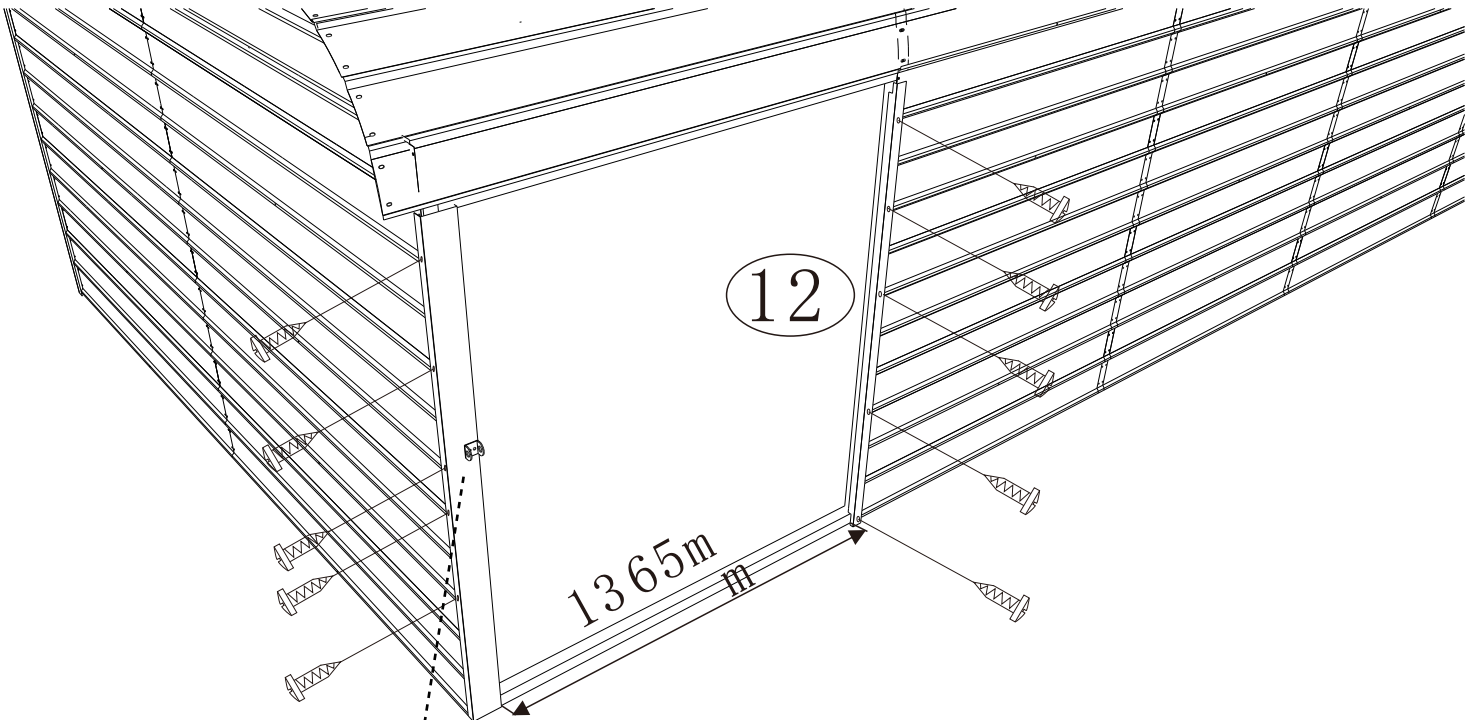
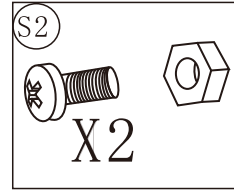
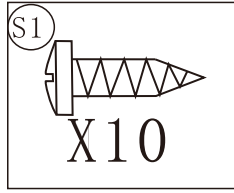
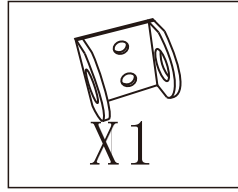

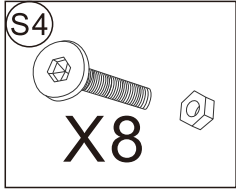

Note hinge orientation to ensure correct installation

STEP-29

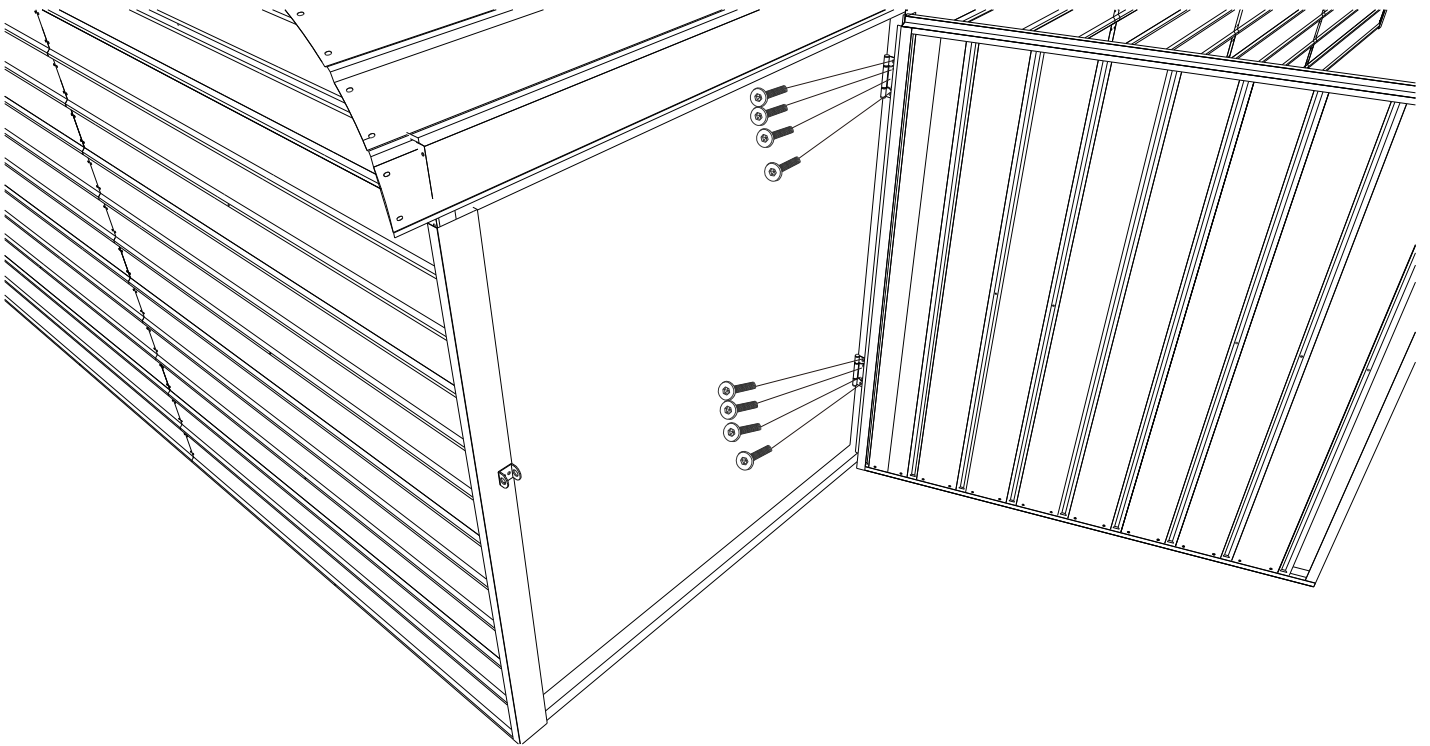
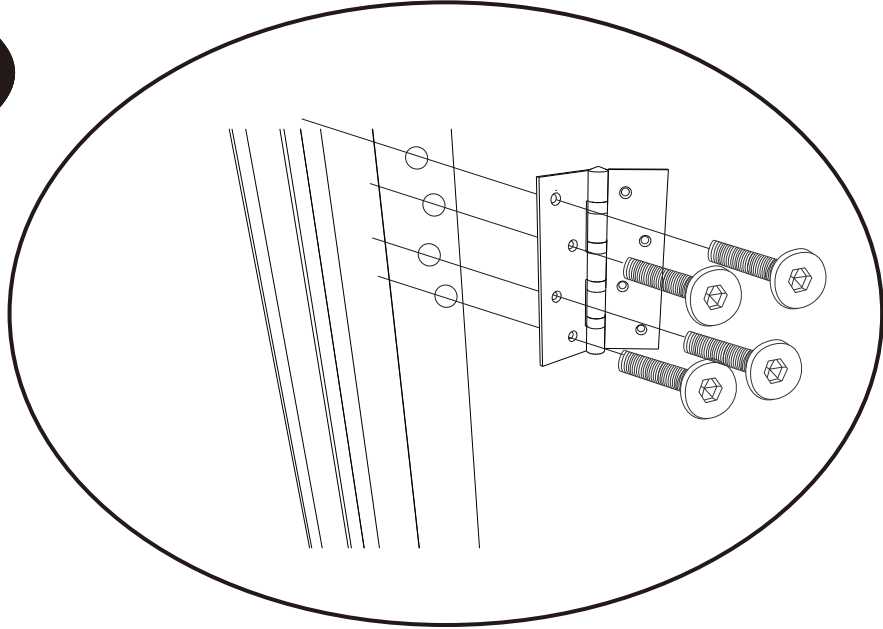

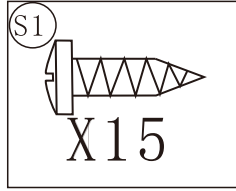
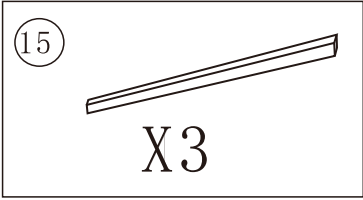

STEP-30

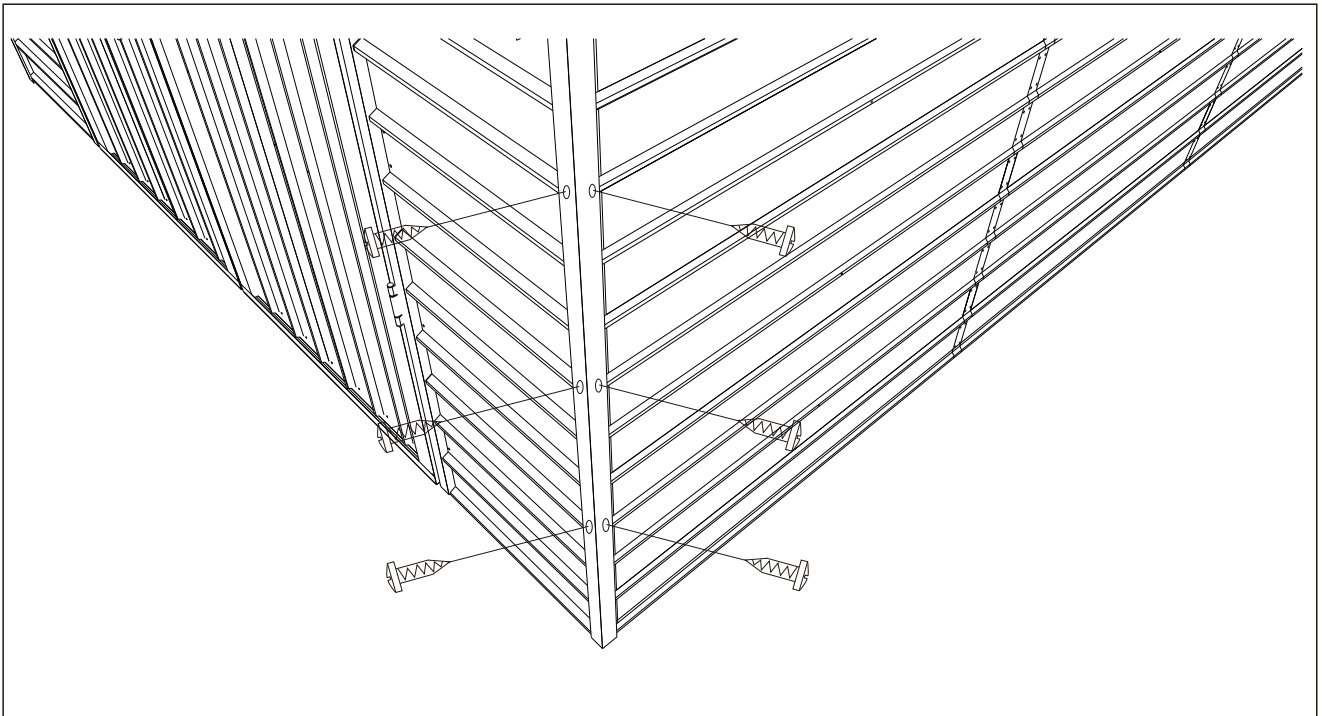
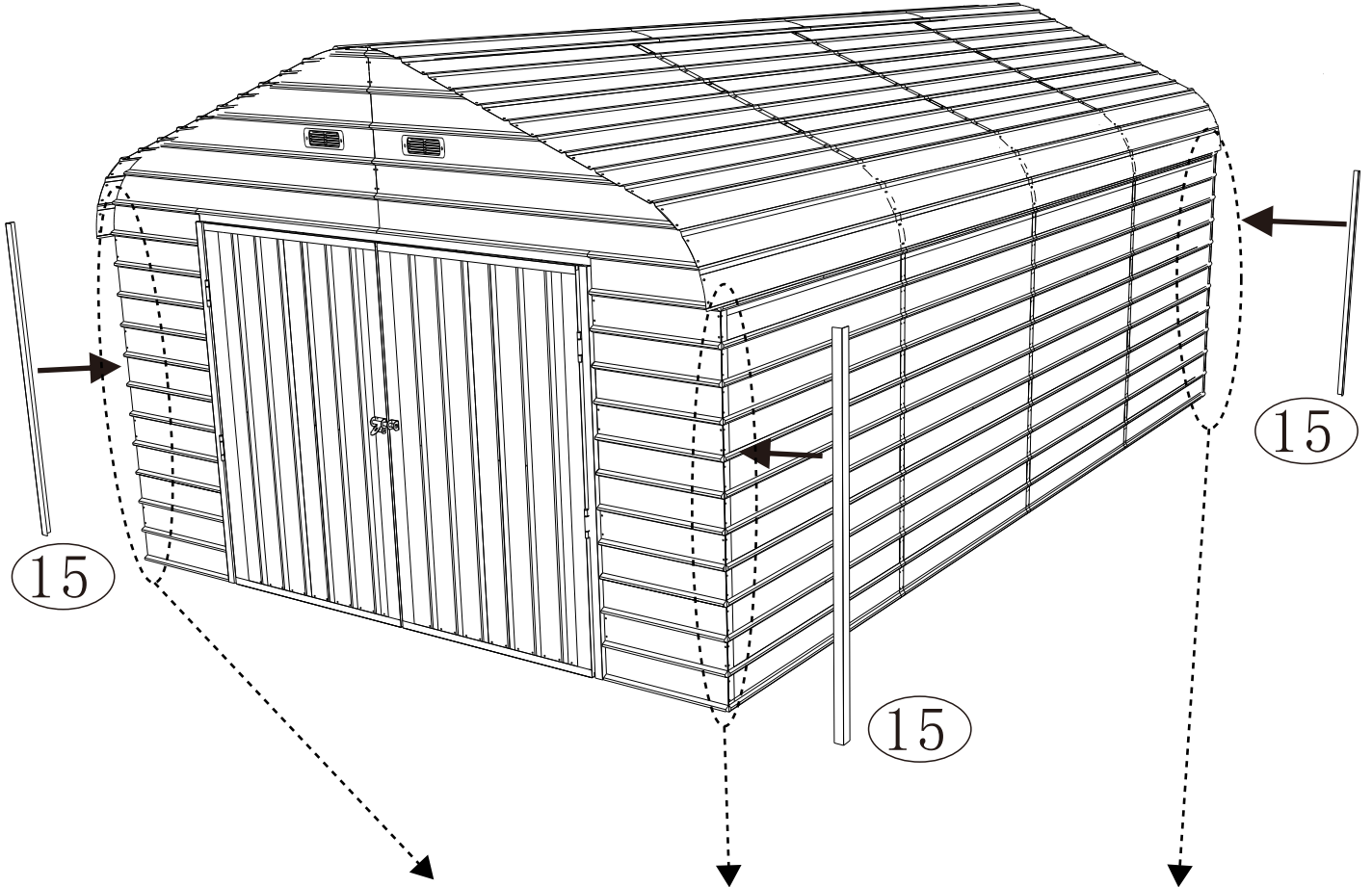

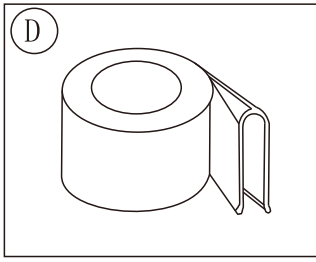

STEP-31

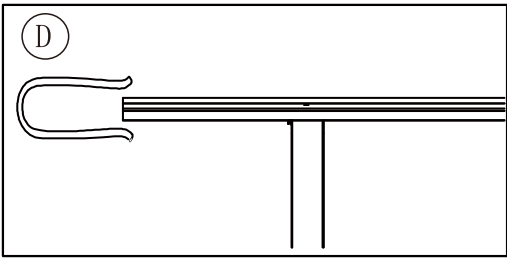

To extend the package of the color steel tile pointed Angle, to prevent injuries

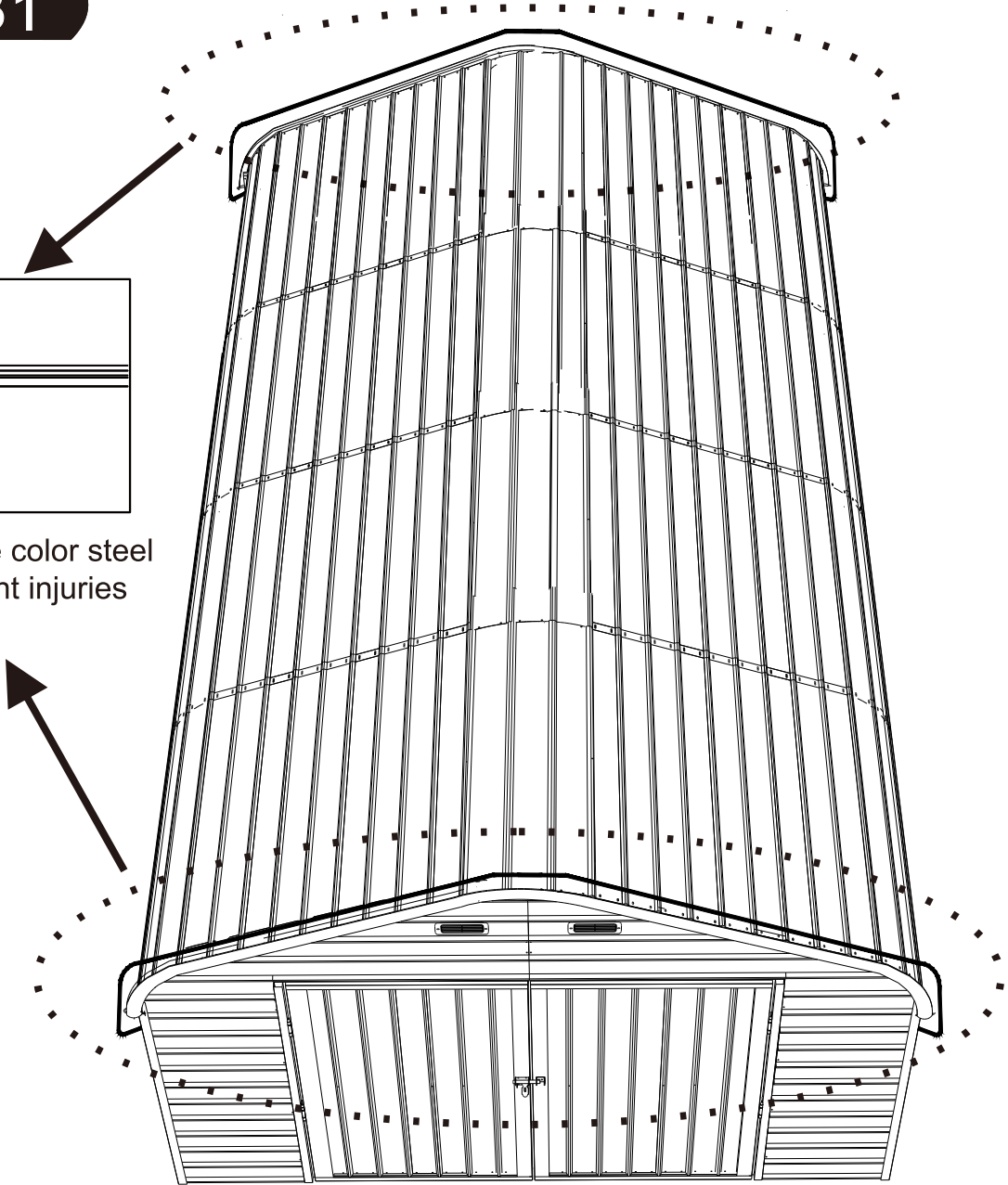

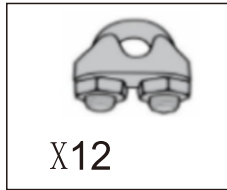
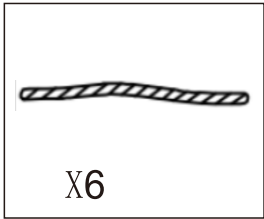
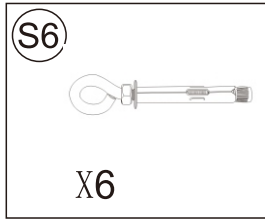
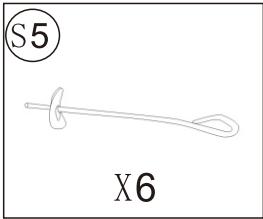

hard ground

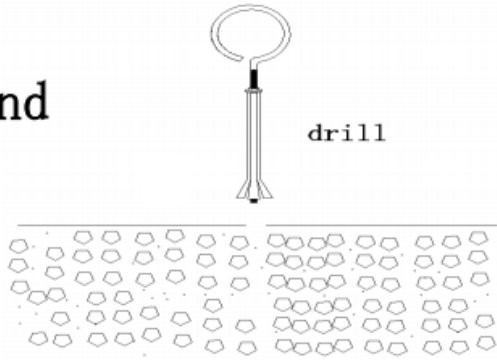

Insert expansion bolts

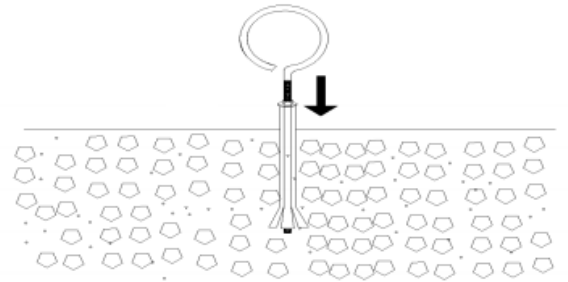

Insert the expansion bolt and rotate the nut to expand and secure the expansion bolt

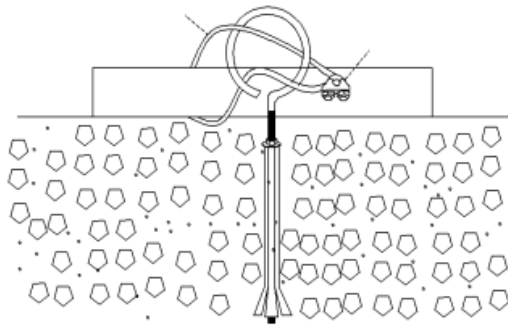
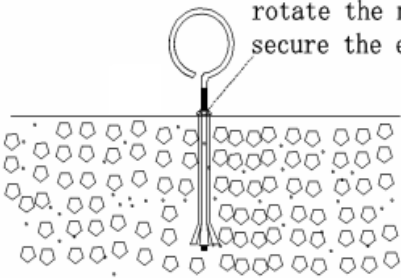

soft ground

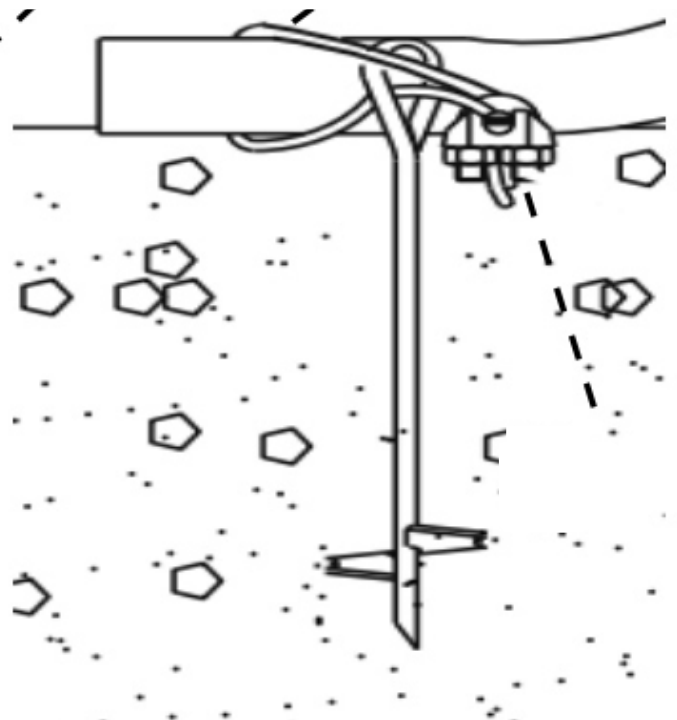
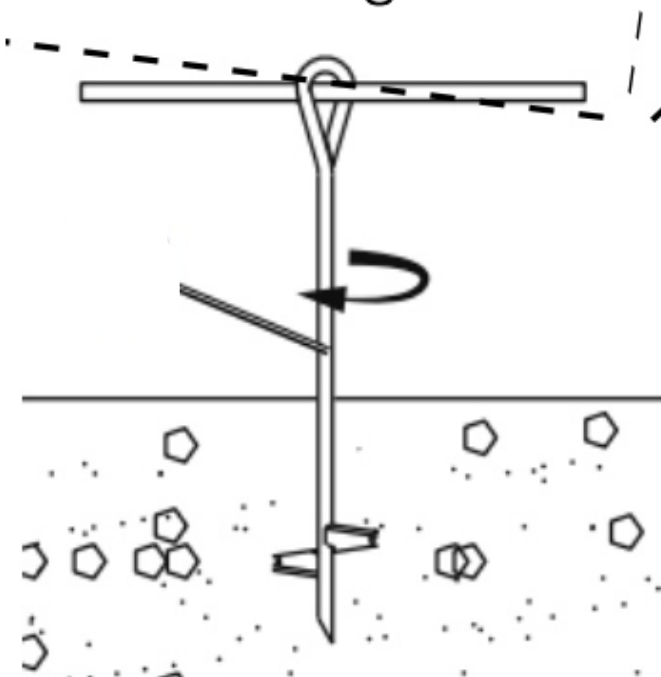

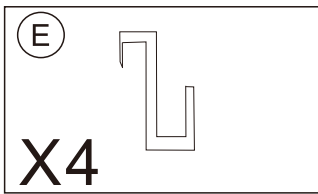

The hook has 20mm on one side and 40mm on the other, allowing flexible installation positioning

