

ASSEMBLY INSTRUCTIONS

24 INCH BATH VANITY - COMBO

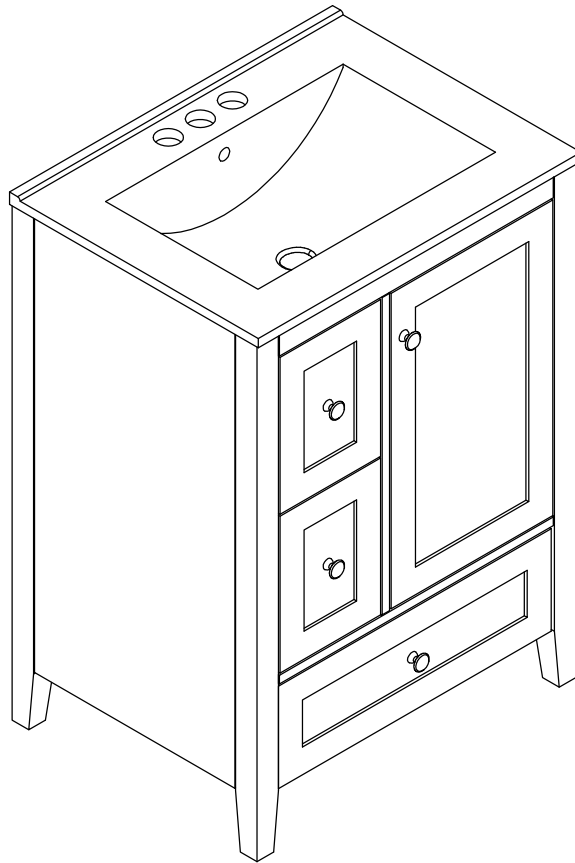

Thank you for purchasing this quality product. Be sure to check all packing material carefully for small parts which may have come loose inside the carton during shipment. Separate, identify and count all parts and hardware.

Compare with the parts list to be sure all parts are present.

"DO NOT TIGHTEN SCREWS UNTIL COMPLETELY ASSEMBLED"

*** Use of power tool to assemble this product will invalidate any claim and damage this product making unsafe !!!**
*** Please assemble on a clean soft surface to avoid damage.**

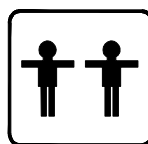
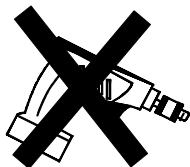

+

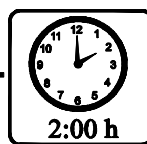

Tools Required

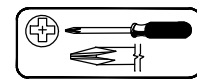

(Not included)

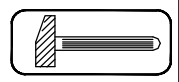

(Not included)

IMPORTANT:

PLEASE READ INSTRUCTION BEFORE STARTING THE ASSEMBLY

Thank you for buying our products.

Please read the installation manual carefully before installation,

we need you to follow the instructions on the accessories and hardware

step by step assembly complete, our instructions are very detailed.

Products are environmentally friendly products,

Please rest assured that you do not soak in water, do not place very heavy items,

do not malicious push and pull,

if you have any problems in the process of assembly and use, please contact us.

Thank you again for your purchase of our products,

I wish you a happy life.

Before Installation

Important - Please read these instructions fully before starting assembly

Thank you for purchasing this quality product. Be sure to check all packing materials carefully for small parts, which may have come loose inside the carton during shipment. Identify and count all items according to the PARTS LIST and/or HARDWARE LIST shown below. Check you have all the components and tools listed on the following pages.

- . We recommend that you assemble this product with the assistance of another person; this will make the assembly easier, and will help eliminate damage to the product or injury to persons during assembly.
- . Please do not over tighten screws or bolts until the assembly is completed.
- . Keep children and animal away from the work area, small parts could choke if swallowed.
- . Please put all parts on a non-abrasive floor before assembly, and follow the assembly steps to assemble your newly purchased product correctly and efficiently.

If you find that you have any trouble with assembly or missing or damaged parts please contact the seller.

Cam Lock Assembly Instructions

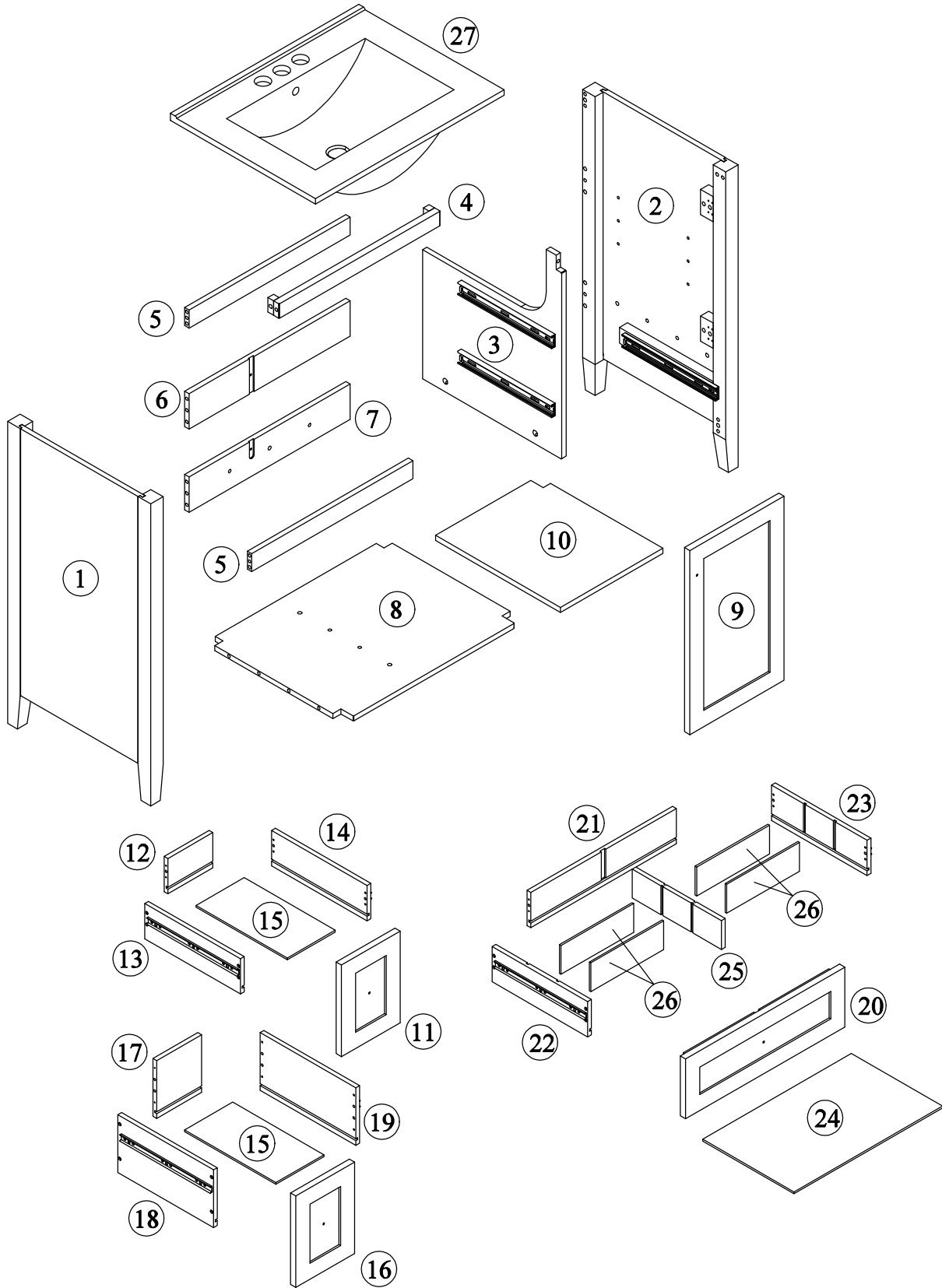
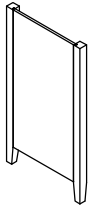
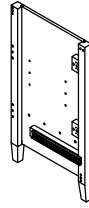
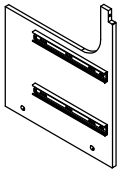
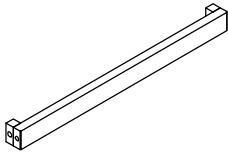
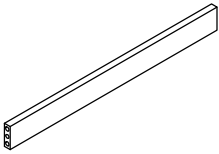
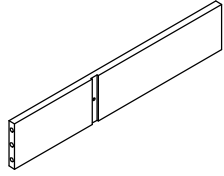
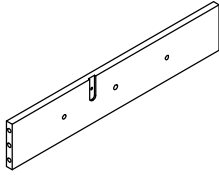
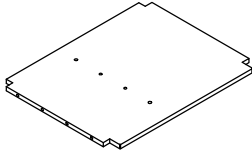
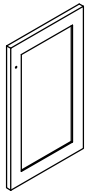
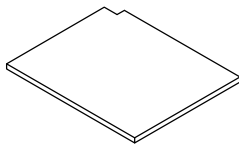
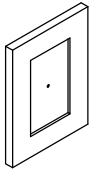

		Diagram A Insert Cam Bolt into hole as shown in diagram A.
		Diagram B Make sure not to insert the Cam Bolt: Too deep as shown in figure B as this will cause the Cam Lock to be misaligned and unable to interlock properly.
		Diagram C Also avoid inserting the Cam Bolt too close to the surface of the hole as shown in figure C, as this will cause the Cam Lock to be too loose, and not interlock properly.
		Connect the panels together.
		ARROW SIGN Insert the Cam Lock so the side opening fits over the head of the Cam Bolt.
		To tighten the Cam Lock, turn it clockwise on half a turn with a flat screwdriver. <i>*Do not use an automatic screwdriver as it may bend or break if too much power is imposed.</i>

Detail View - CABINET



Identifying the Hardware-Identify the hardware using the illustrations below.



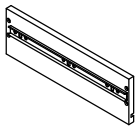
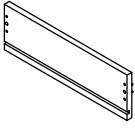



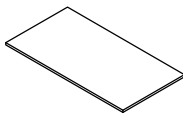
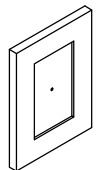
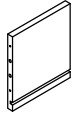
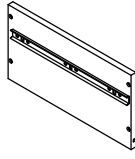
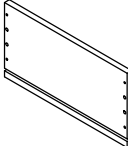
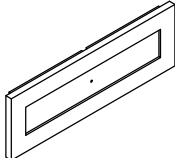
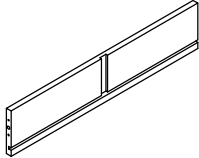
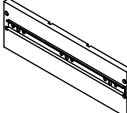
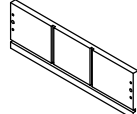
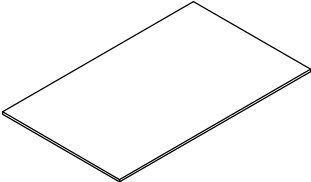
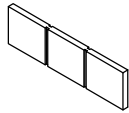
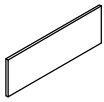
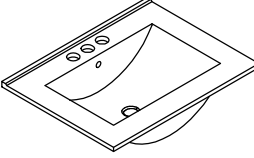

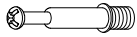

Part List

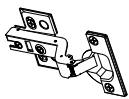
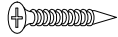
<p>1</p>  <p>Side Panel (L) - 1pc</p>	<p>2</p>  <p>Side Panel (R) - 1pc</p>
<p>3</p>  <p>Mid Panel - 1pc</p>	<p>4</p>  <p>Top Panel Rear - 1pc</p>
<p>5</p>  <p>Top + Bottom Panel - 2pcs</p>	<p>6</p>  <p>Mid Panel Rear - 1pc</p>
<p>7</p>  <p>Bottom Panel Rear - 1pc</p>	<p>8</p>  <p>Bottom Panel - 1pc</p>
<p>9</p>  <p>Cabinet Door - 1pc</p>	<p>10</p>  <p>Adjustable Shelf - 1pc</p>
<p>11</p>  <p>Drawer Face (A) - 1pc</p>	<p>12</p>  <p>Drawer Back Panel (A) - 1pc</p>
<p>13</p>  <p>Drawer Side Panel Left (A) - 1pc</p>	<p>14</p>  <p>Drawer Side Panel Right (A) - 1pc</p>

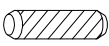
Part List

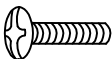
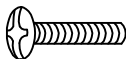
<p>15</p>  <p>Bottom Drawer Panel (A&B) - 2pcs</p>	<p>16</p>  <p>Drawer Face (B) - 1pc</p>
<p>17</p>  <p>Drawer Back Panel (B) - 1pc</p>	<p>18</p>  <p>Drawer Side Panel Left (B) - 1pc</p>
<p>19</p>  <p>Drawer Side Panel Right (B) - 1pc</p>	<p>20</p>  <p>Drawer Face (C) - 1pc</p>
<p>21</p>  <p>Drawer Back Panel (C) - 1pc</p>	<p>22</p>  <p>Drawer Side Panel Left (C) - 1pc</p>
<p>23</p>  <p>Drawer Side Panel Right (C) - 1pc</p>	<p>24</p>  <p>Bottom Drawer Panel (C) - 1pc</p>
<p>25</p>  <p>Drawer divide (A) - 1pc</p>	<p>26</p>  <p>Drawer divide (B) - 4pcs</p>
<p>27</p>  <p>Sink - 1pc</p>	

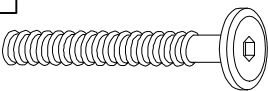
Hardware List

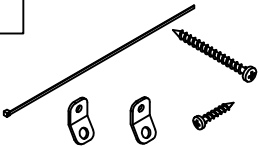
<p>A</p>  <p>ø6x35mm</p>	<p>B</p>  <p>ø14.5x12mm</p>	<p>C</p>  <p>ø8xø4x32mm</p>
<p>Three in one bolts(19pcs) Three in one lock(19pcs) Round head screw(26pcs)</p>		
<p>D</p> 	<p>E</p>  <p>ø7xø3.5x12mm</p>	<p>F</p>  <p>ø8x30mm</p>
<p>Damping hinge (2pcs) Flat head screw(12pcs) Wood dowel(23pcs)</p>		
<p>G</p>  <p>ø6x30mm</p>	<p>H</p> 	<p>I</p> 
<p>Wood dowel(16pcs) Laminate pad - 4pcs Handle (4pcs)</p>		
<p>J</p>  <p>ø5/32"x18mm</p>	<p>K</p>  <p>ø5/32"x22mm</p>	<p>L</p>  <p>ø5/32"x30mm</p>
<p>Handle screw (1pc) Handle screw (1pc) Handle screw (2pcs)</p>		
<p>M</p>  <p>ø13x1/4"x28mm</p>	<p>N</p>  <p>ø1/4"x16x1mm</p>	<p>O</p>  <p>4mm</p>
<p>Hex-Head bolts(2pcs) Washer(2pcs) Allen key(1pc)</p>		
<p>P</p>  <p>Anti fall hardware(2set)</p>		

STEP: 1

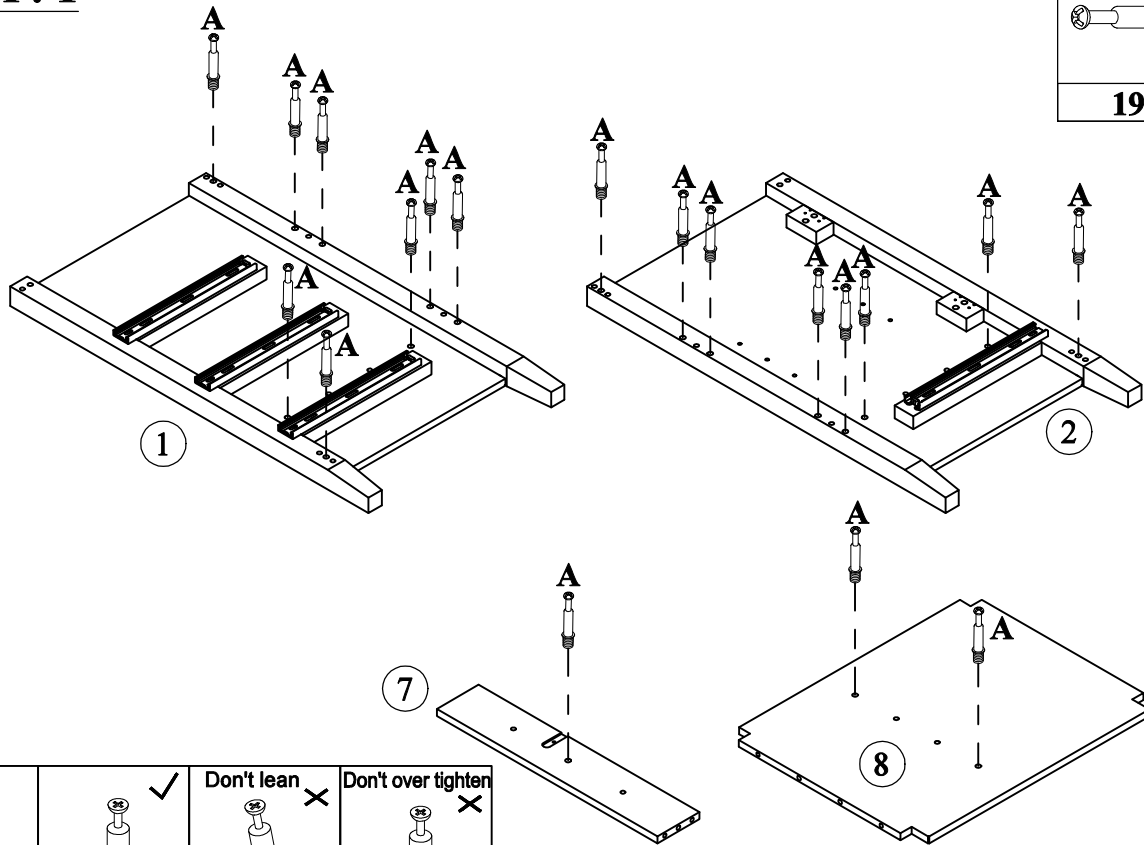

A

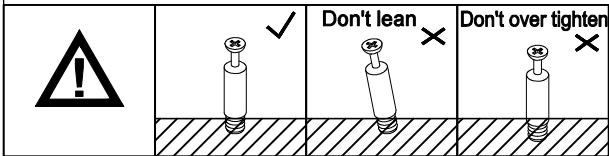
19PCS



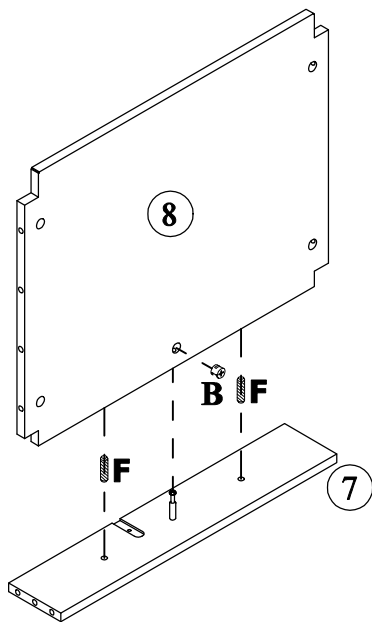

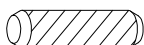

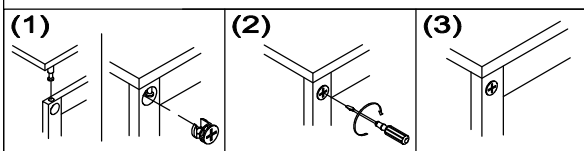
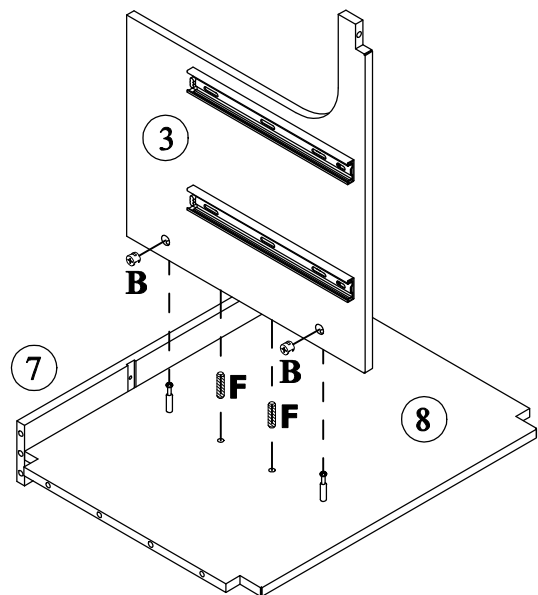
STEP: 2



B 	F 
3PCS	4PCS



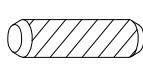
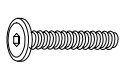

STEP: 3

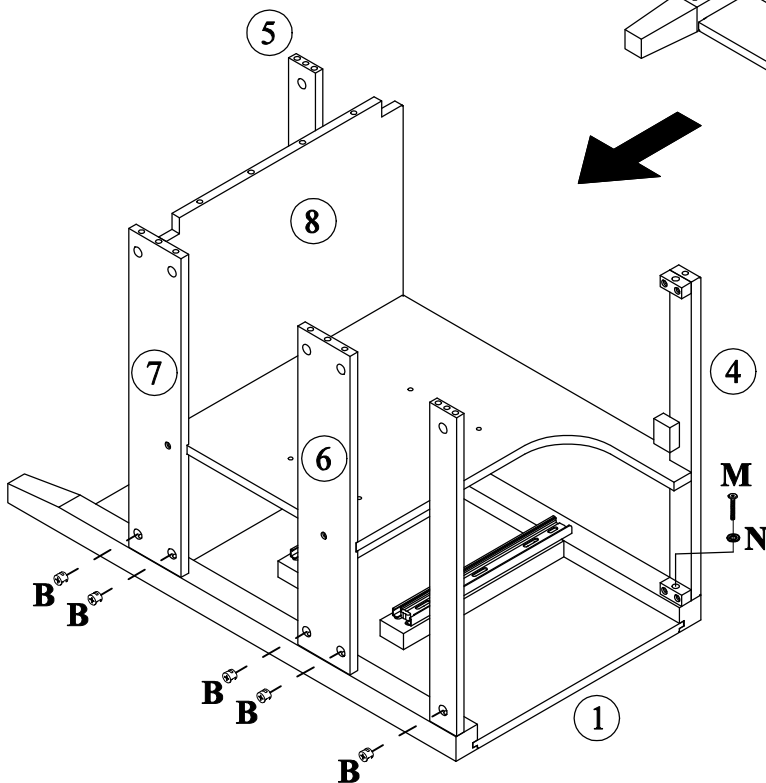
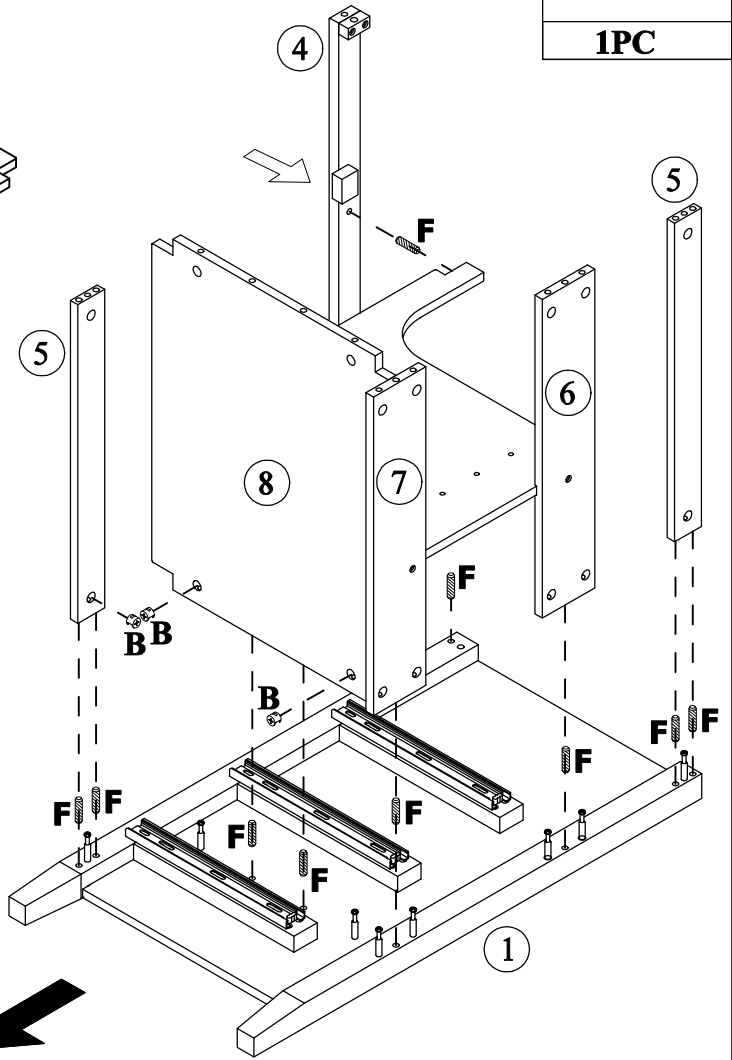
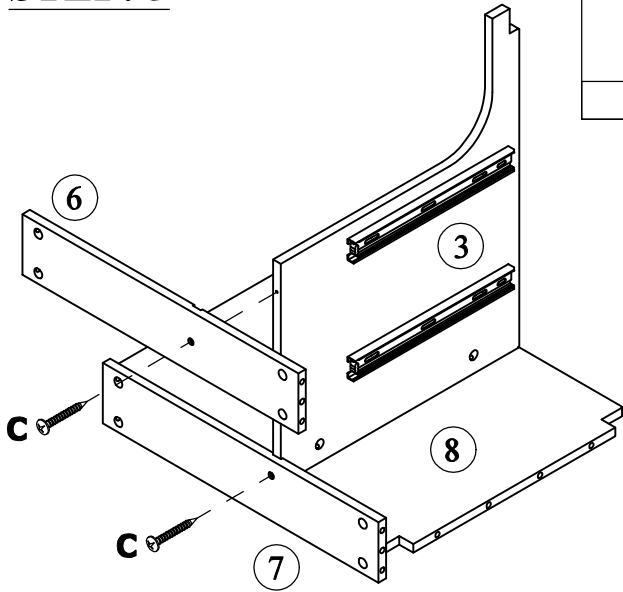
B		C		F		M	
8PCS		2PCS		10PCS		1PC	
						N	
						1PC	

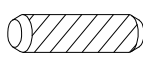

STEP: 4

B 	F 	M 
8PCS	9PCS	1PC
		N 
		1PC

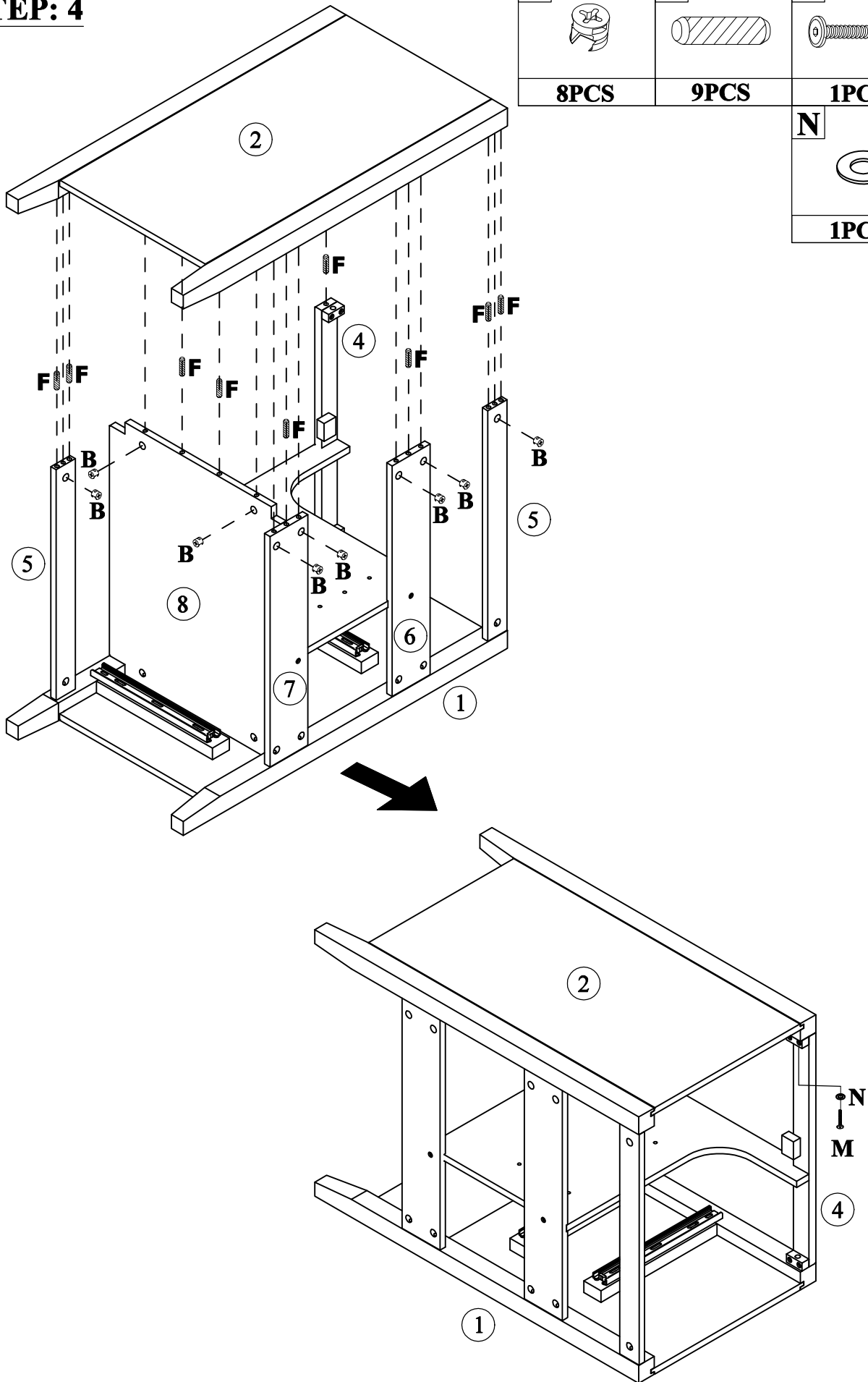

STEP: 5

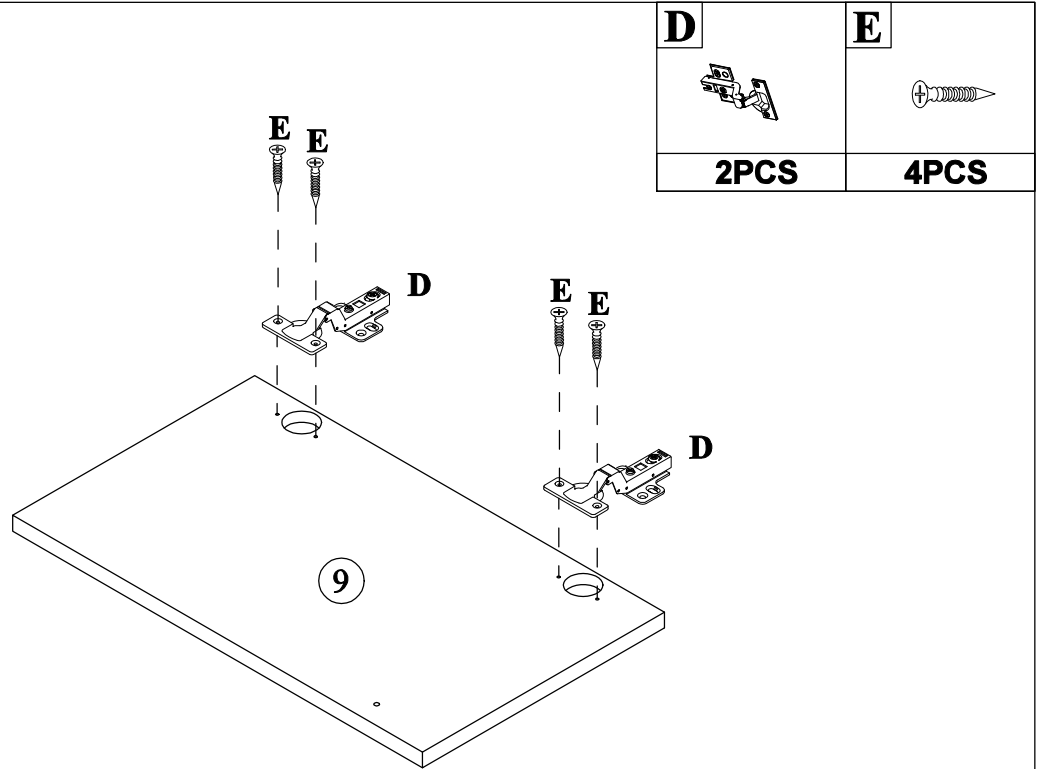

STEP: 6

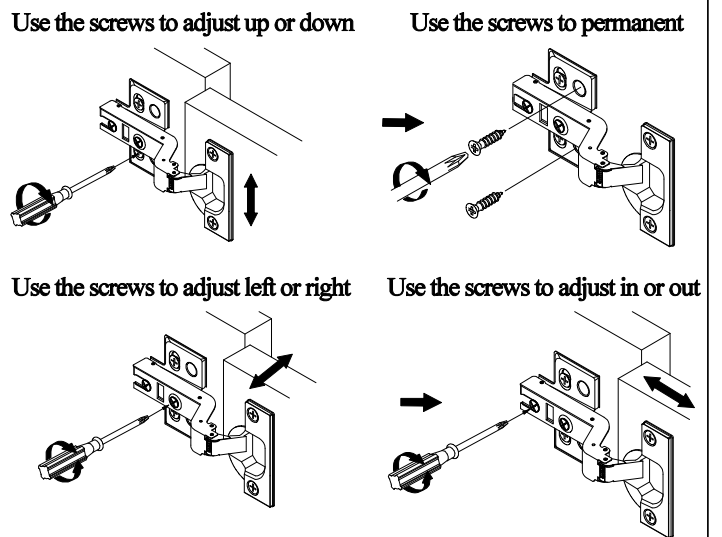
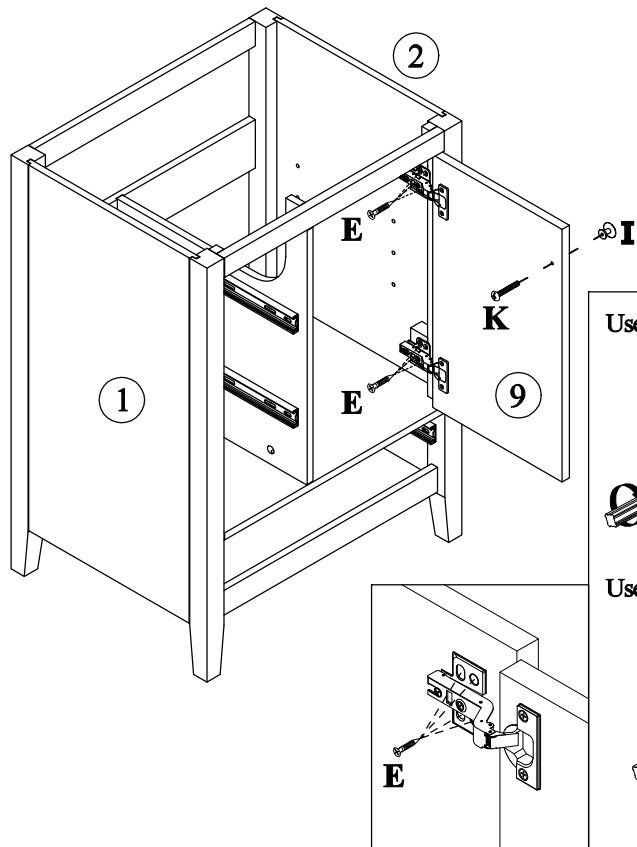

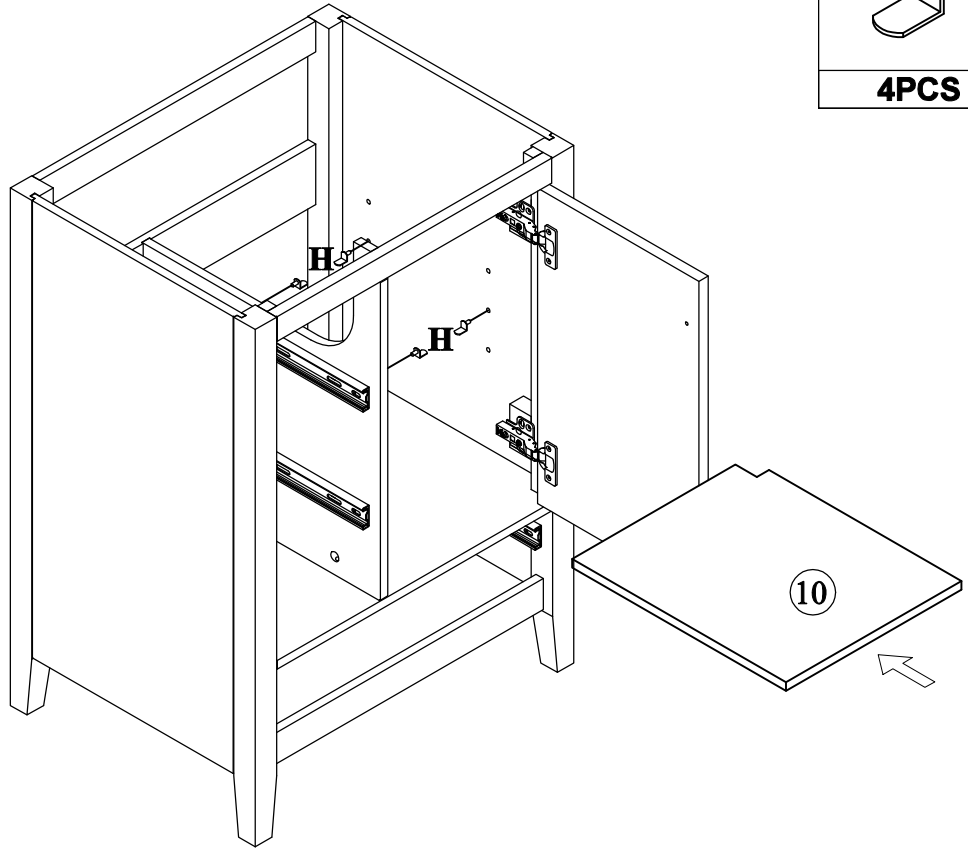

STEP: 7

H	
4PCS	



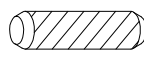

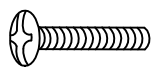
STEP: 8

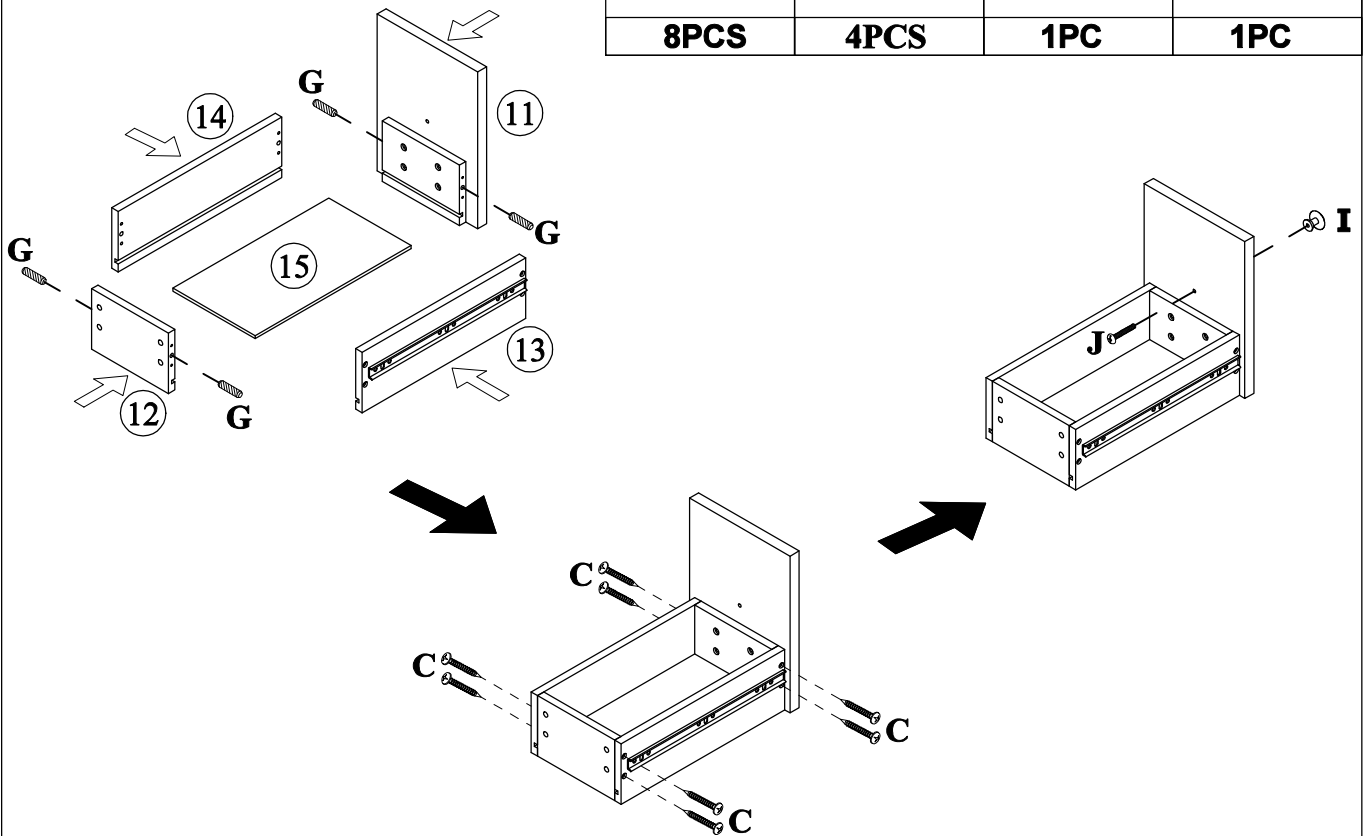
C	G	I	J
			
8PCS	4PCS	1PC	1PC



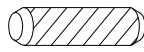

STEP: 9

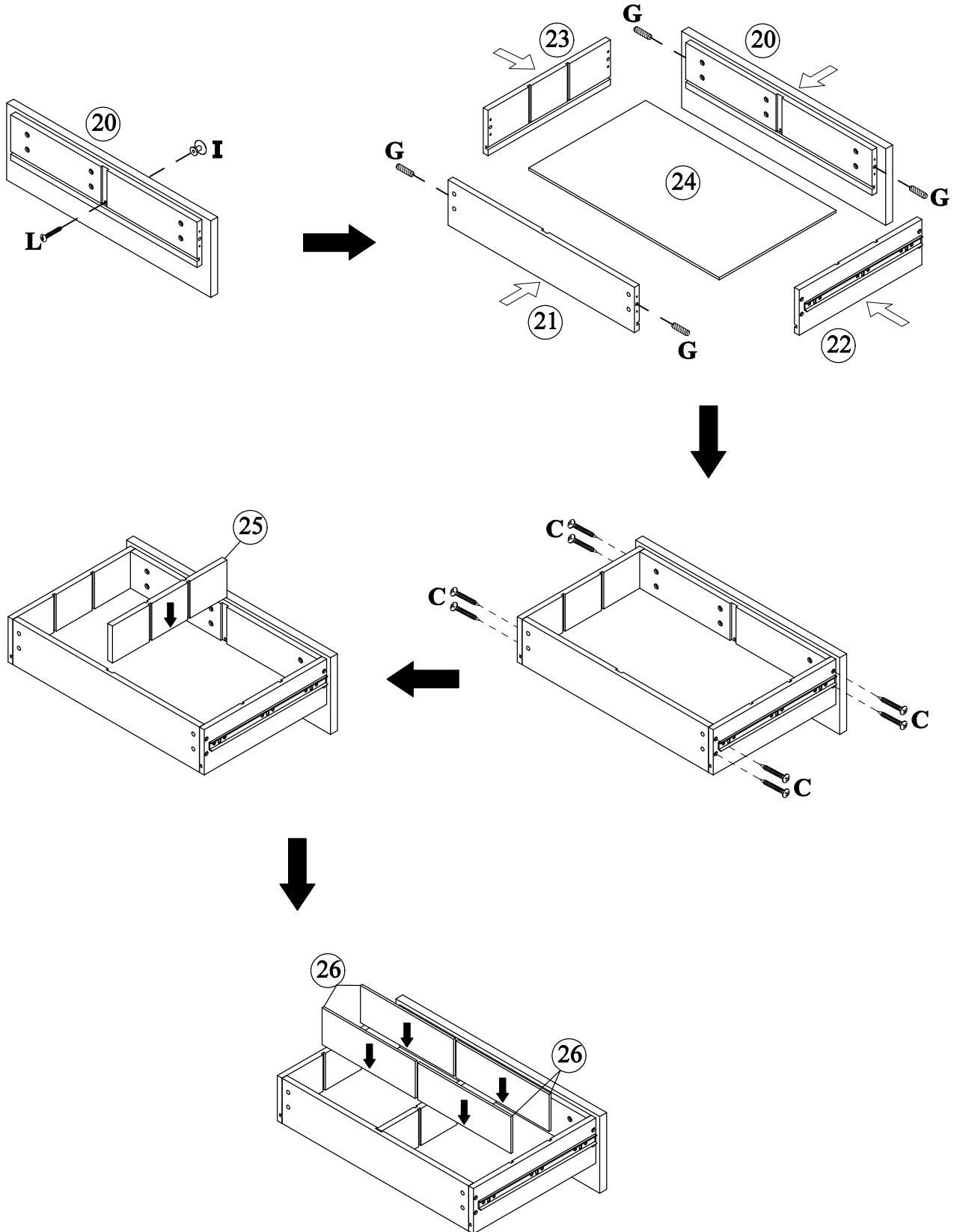
C 	G 	I 	L 
8PCS	4PCS	1PC	1PC

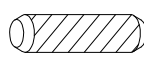

STEP: 10

C	G	I	L
			
8PCS	8PCS	1PC	1PC

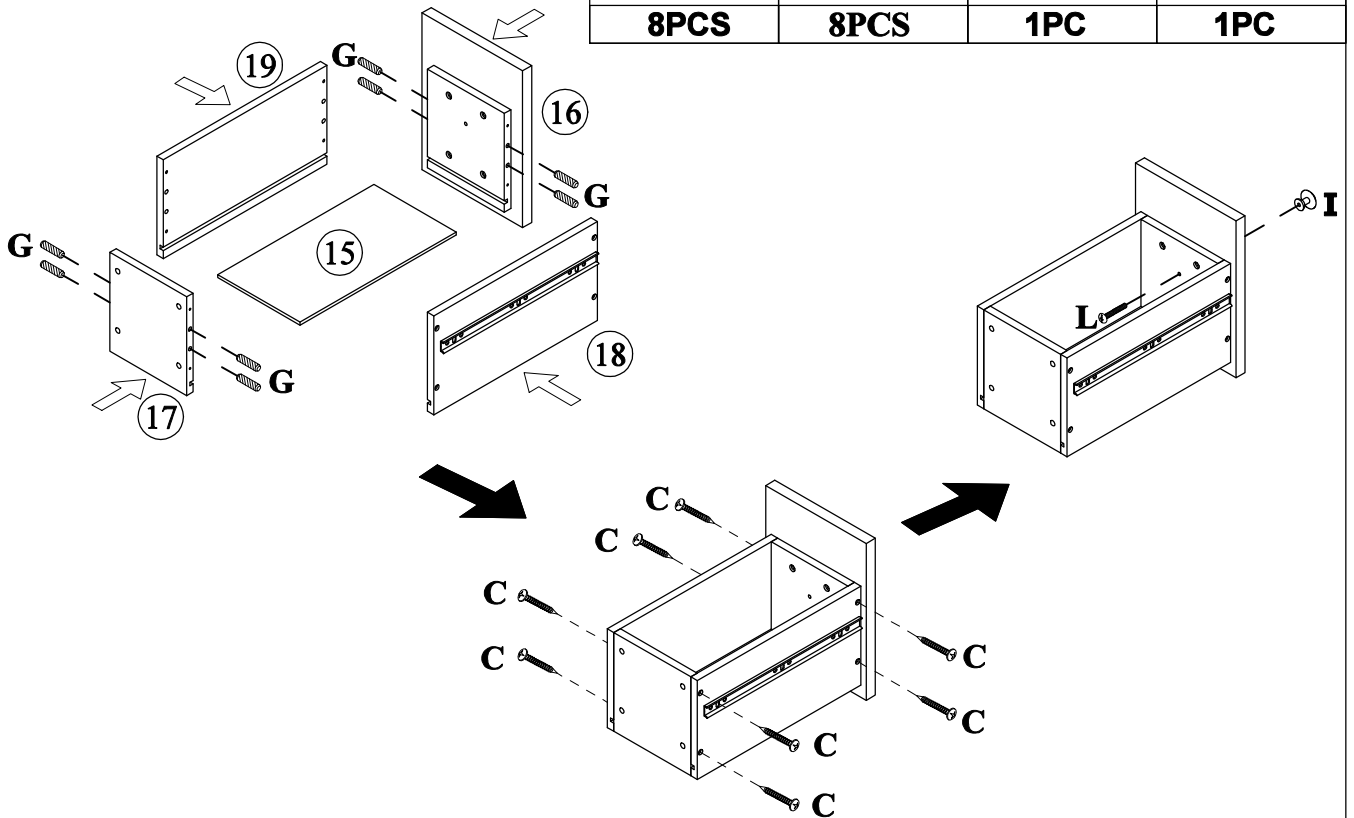

STEP: 11

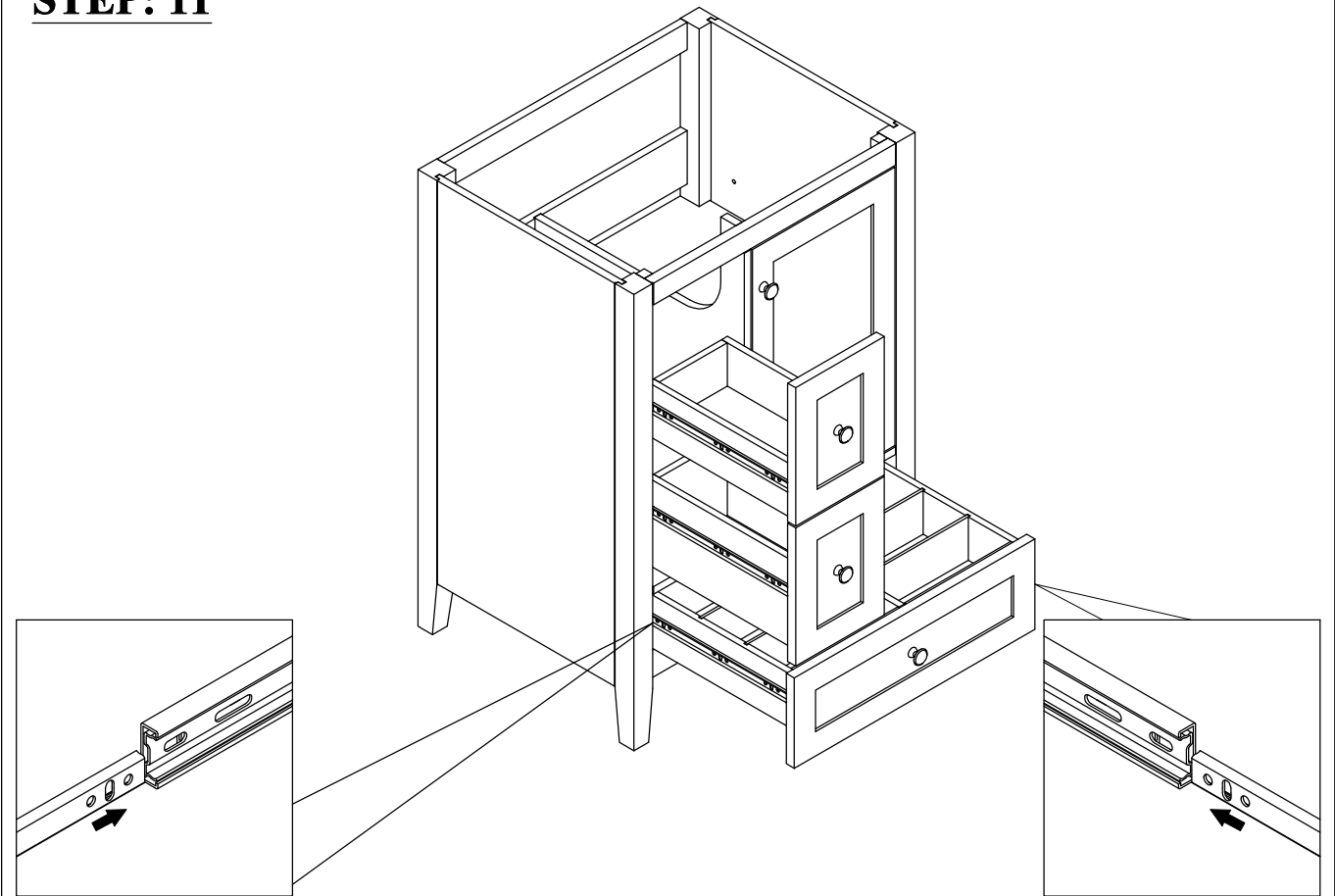

STEP: 12

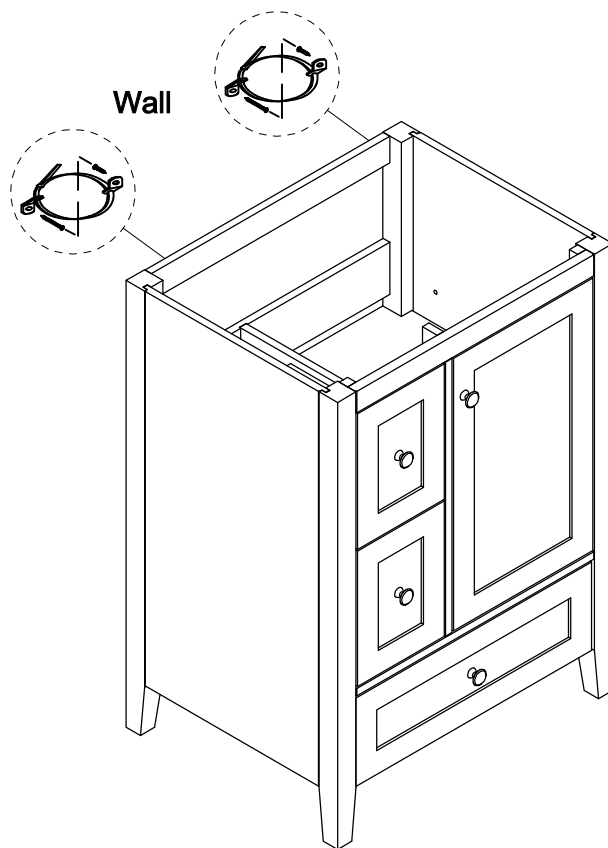

P

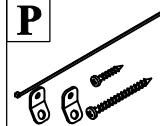

2SET

STEP: 13

**Install the sink on the cabinet with glue.
Let stand for 24 hours**

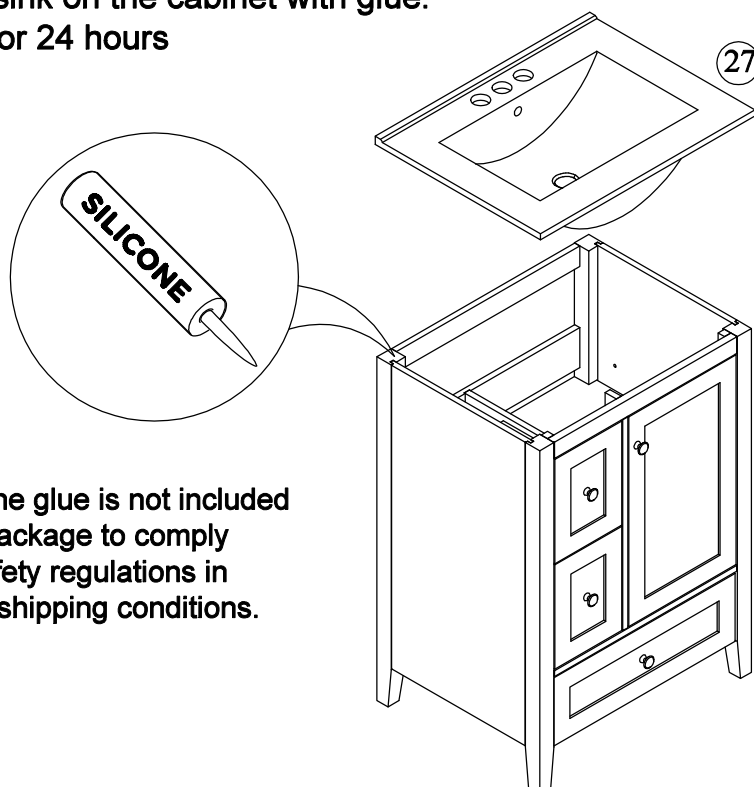

***Silicone glue is not included
in the package to comply
with safety regulations in
certain shipping conditions.**

STEP: 14

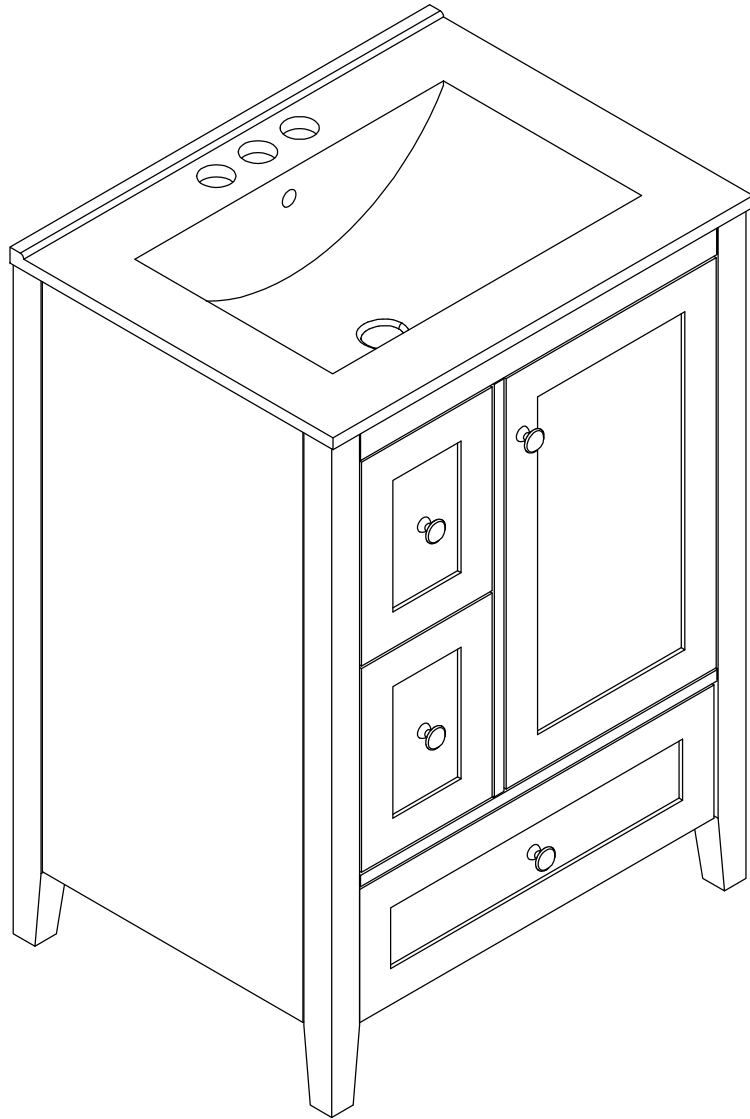

HINGE ADJUSTMENTS



1 Sideways / Tilt adjustment

Turn the screw
clockwise to move the door further away from
the side of the cabinet
anticlockwise to move the door closer to the
side of the cabinet

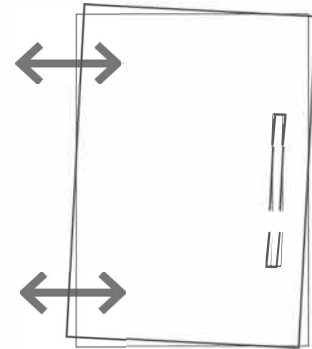

2 4 Height adjustment

While supporting the weight of the door, turn the
screws
clockwise to move the door up
anticlockwise to move the door down

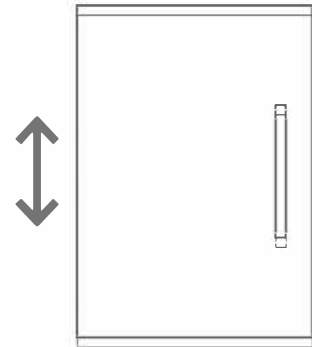

3 Forward and back adjustment

If the gap between the back of the door and the
cabinet is too small, and the door may not close
fully. Turn the screw
clockwise to decrease the gap between the
door and the cabinet
anticlockwise to increase the gap between the
door and the cabinet

