

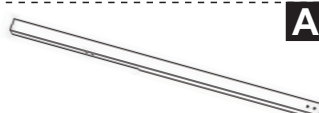

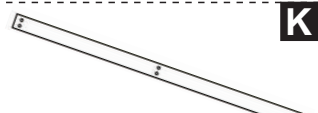

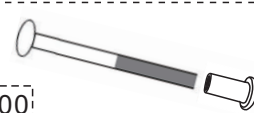

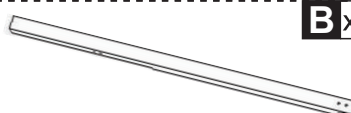



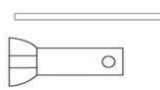



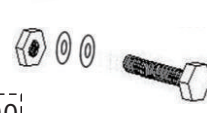

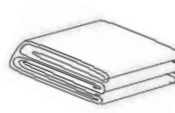

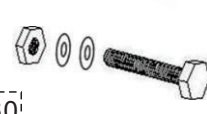





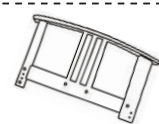
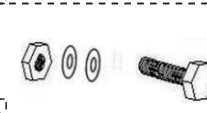

two or more people for assembly.

ASSEMBLY INSTRUCTION

	A x 2		K x 2		V x 2
	B x 2		L x 2		U x 2
	C x 2		M x 10		W x 20
	D x 1		N x 4		X x 2
	E x 2		O x 1		Y x 2
	F x 1		P x 2		Z x 4
	G x 2		Q x 2		① x 2
	H x 2		R x 8		② x 2
	I x 2		S x 8		③ x 2
	J x 2		T x 2		④ x 1
					⑤ x 1

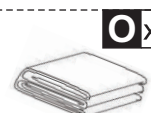
	G x 2		O x 1
	H x 2		W x 4

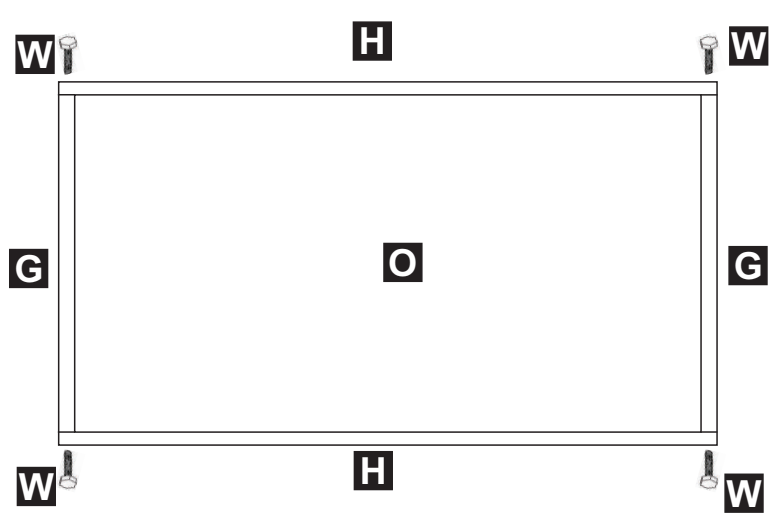

Fit H and G with the cover O, then install H with G as shown in picture.

A x 2

P x 2

Q x 2

R x 8

T x 2

X x 2

M10*160

M10*140

M10*90

M10*55

M10*90

B x 2

C x 2

D x 1

E x 2

F x 1

N x 4

M10*100

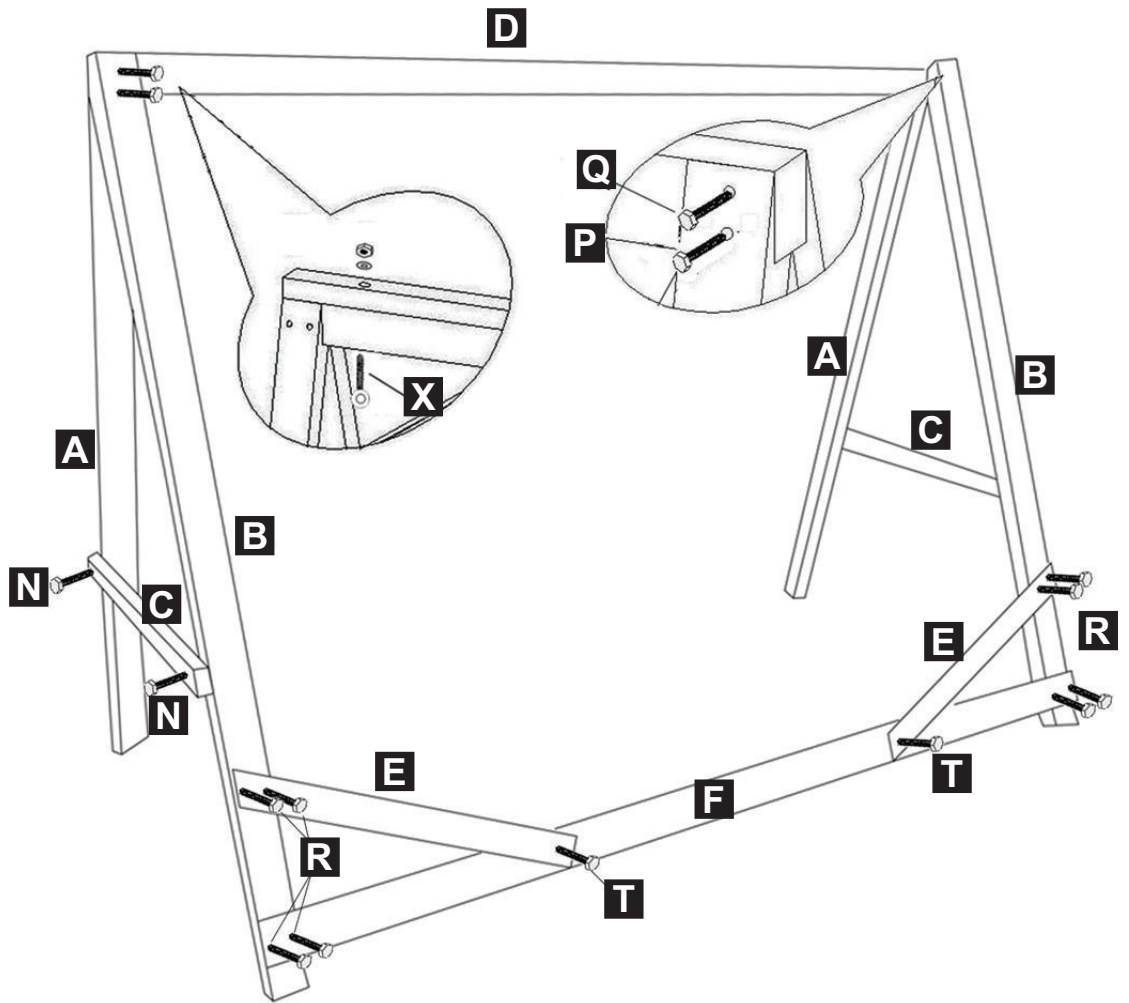

V x 2

M8*100

01 STEP

02 STEP

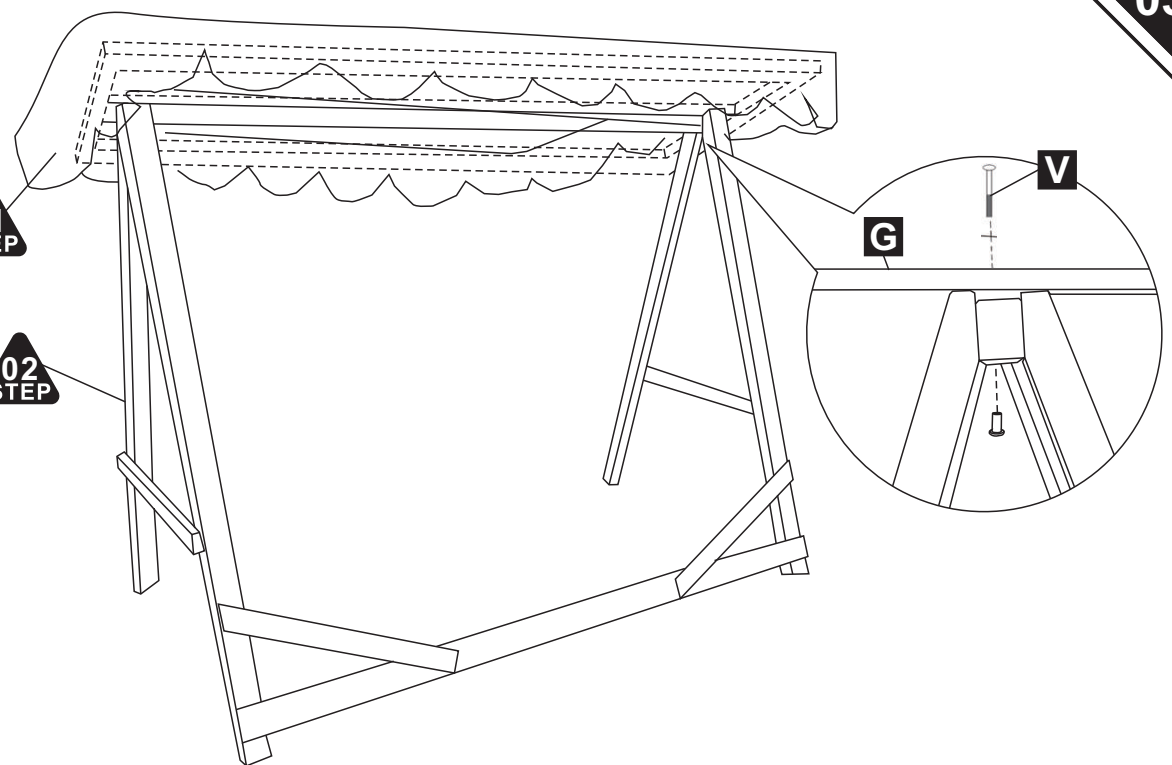

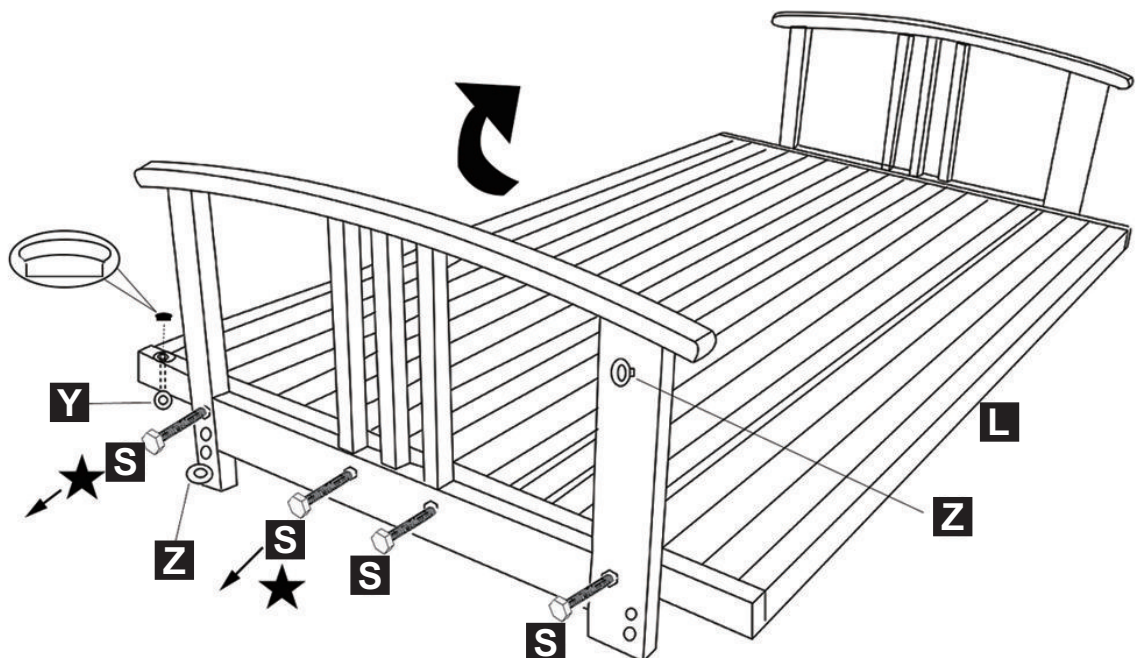
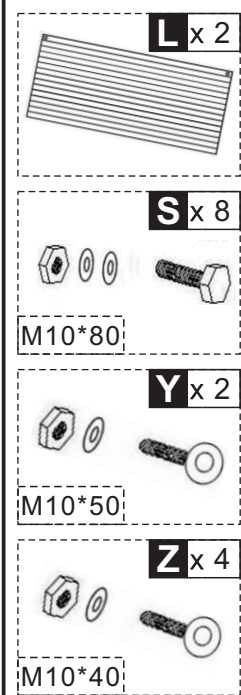
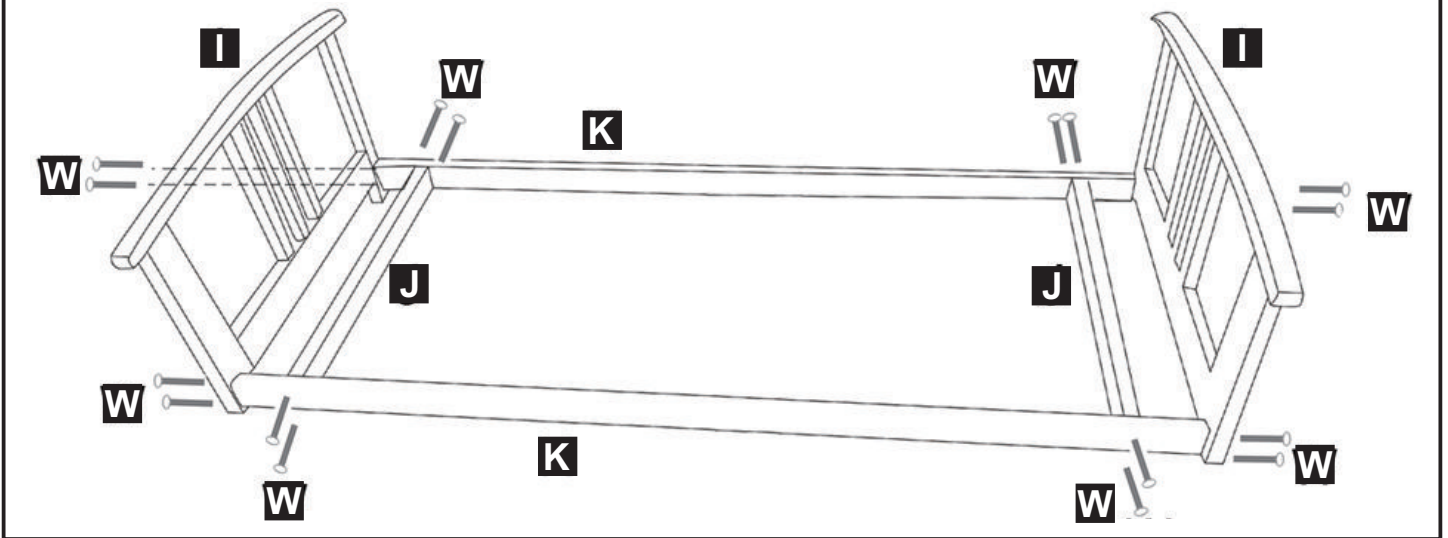
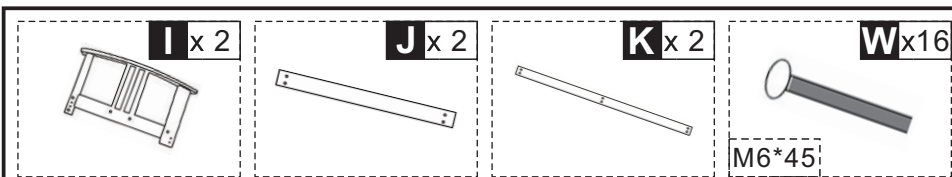

To turn the swing bed into swing chair: Remove the screw S which are marked with ★ in the picture. Stand the back board Y up and fix Y with X by using the short chain.

M x 6

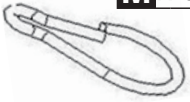

1 x 2



2 x 2



03 STEP

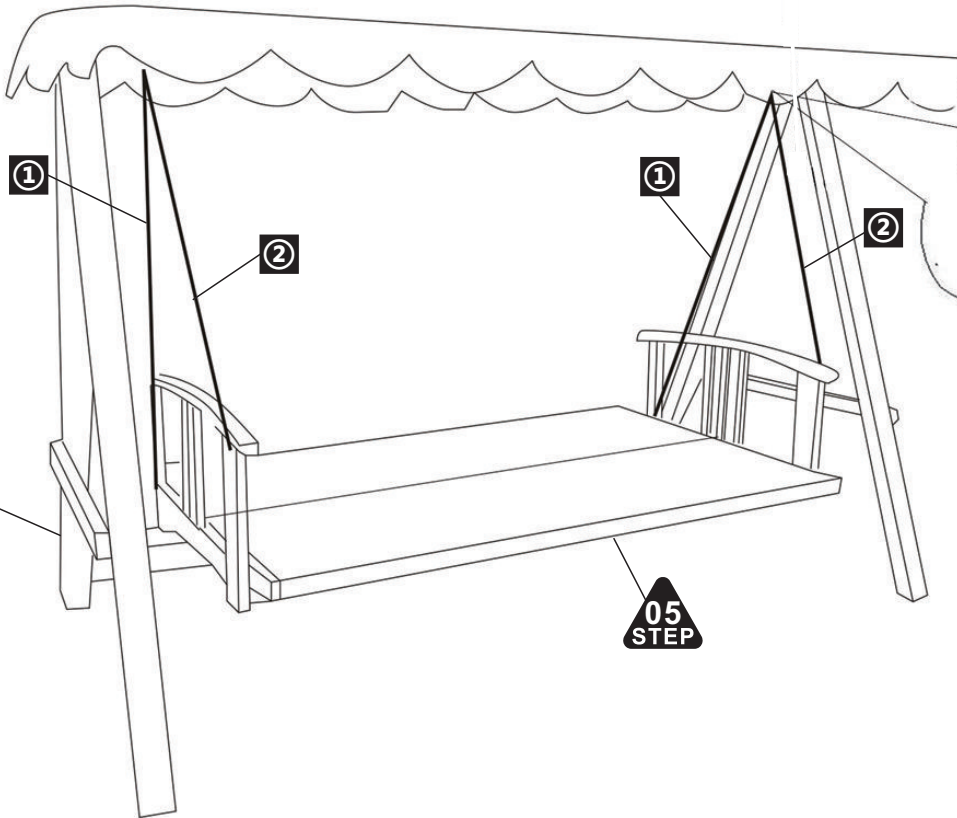

05 STEP

M x 4

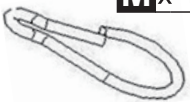

3 x 2

