

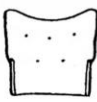







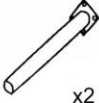

# ASSEMBLY INSTRUCTIONS

|  |  |   |   |   |  |   |  |  |  |   |
|--|--|---|---|---|--|---|--|--|--|---|
| <p>A</p>  | <p>B</p>  | <p>C</p>  <p>x2<br/>chair front feet</p> | <p>D</p>  <p>x2<br/>back leg with adjustable screw</p> | <p>E</p>  <p>x24</p> | <p>F</p>  <p>x2</p> | <p>G</p>  <p>x24</p> | <p>H</p>  <p>x2</p> | <p>I</p>  <p>x1</p> | <p>J</p>  | <p>K</p>  <p>x4<br/>Ottoman feet</p> |
|--|--|---|---|---|--|---|--|--|--|---|

**1.**

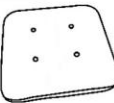

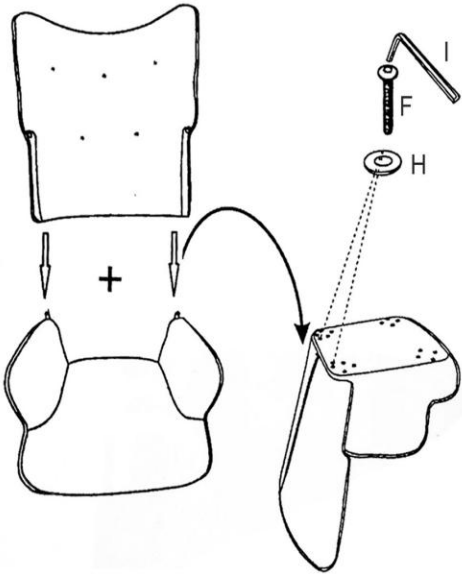
**2.**

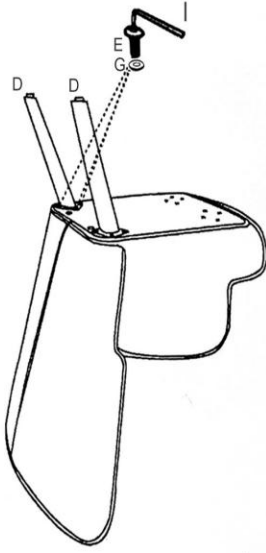

**3.**

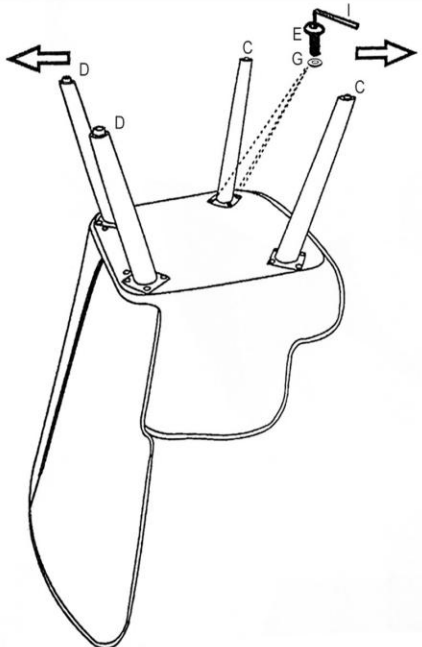

**4.**

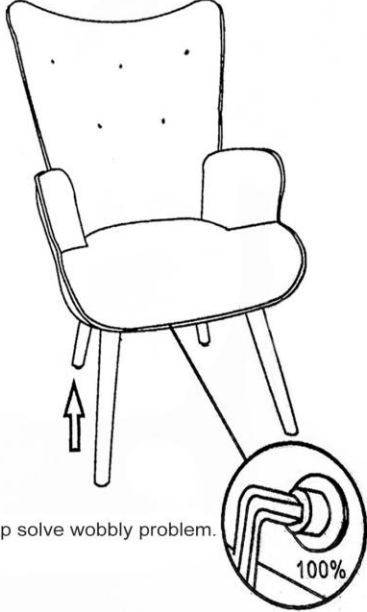

Adjust the screw to solve wobbly problem.

100%



5. Turn the bottom of the product up.

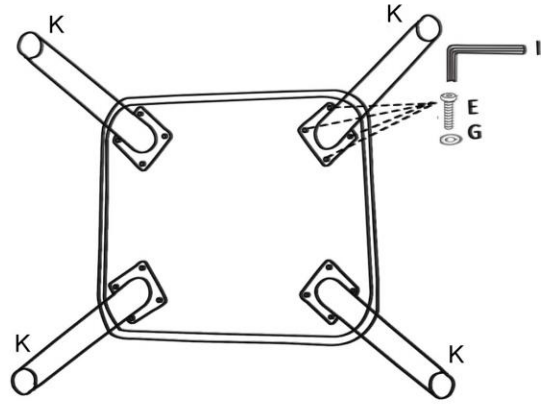
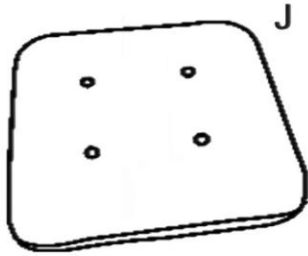

6. Finish.

