



**INSTRUCTIONS D'ASSEMBLAGE  
ASSEMBLY INSTRUCTIONS**

---

---

**TABLE D'APPOINT -  
METAL CHROME / TAUPE FONCE ET TIROIR**

**ACCENT TABLE -  
CHROME METAL / DARK TAUPE WITH A DRAWER**



**POUR DE L'ASSISTANCE OU POUR COMMANDER  
DES PIÈCES CONTACTEZ NOTRE DÉPARTEMENT  
DE SERVICE À LA CLIENTÈLE.**

**FOR ASSISTANCE OR TO ORDER PARTS  
CONTACT OUR CUSTOMER SERVICE DEPARTMENT**

## LISTE DES PIÈCES PARTS LIST

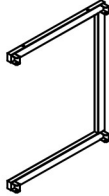
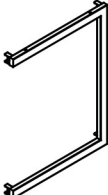
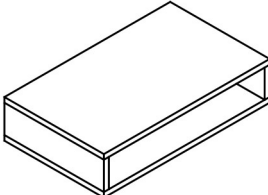
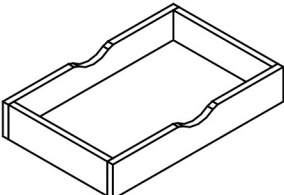
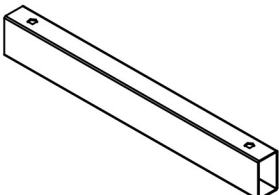
PIÈCE / PART #	IMAGE	DESCRIPTION	QTY / QTÉ
<b>1</b>		<b>FRONT FACING LEFT LEG PATTE AVANT GAUCHE</b>	<b>1</b>
<b>2</b>		<b>FRONT FACING RIGHT LEG PATTE AVANT DROITE</b>	<b>1</b>
<b>3</b>		<b>TABLE TOP SURFACE DE TABLE</b>	<b>1</b>
<b>4</b>		<b>DRAWER TIROIR</b>	<b>1</b>
<b>5</b>		<b>STRETCHER CHÂSSIS</b>	<b>4</b>

## LISTE DES PIÈCES DE MONTAGE HARDWARE LIST

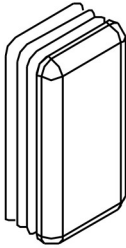
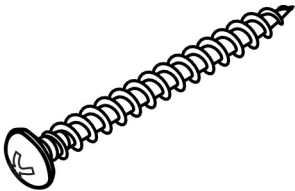
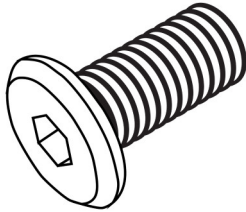
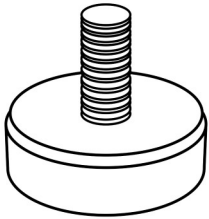
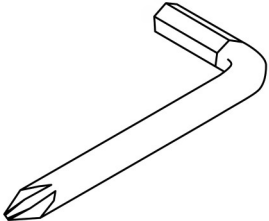
PIÈCE / PART #	IMAGE	DESCRIPTION	QTY / QTÉ
<b>A</b>		CAP - 1/2" X 1" CAPUCHON - 1/2" X 1"	4
<b>B</b>		ASSEMBLING SCREW - Ø1/8" X 1 3/8" VIS D'ASSEMBLAGE - Ø1/8" X 1 3/8"	4
<b>C</b>		ASSEMBLING BOLT - Ø1/4" X 1/2" BOULON D'ASSEMBLAGE - Ø1/4" X 1/2"	8
<b>D</b>		ADJUSTABLE LEG - Ø1/4" X 3/8" PATTE AJUSTABLE - Ø1/4" X 3/8"	4
<b>E</b>		HEX KEY CLÉ HEXAGONALE	1

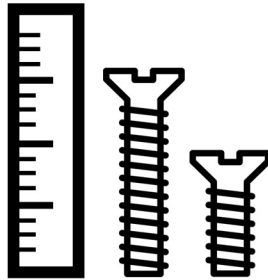

OUTIL DE VÉRIFICATION DE DIMENSIONS DES PIÈCES  
HARDWARE DIMENSIONS VERIFICATION TOOL

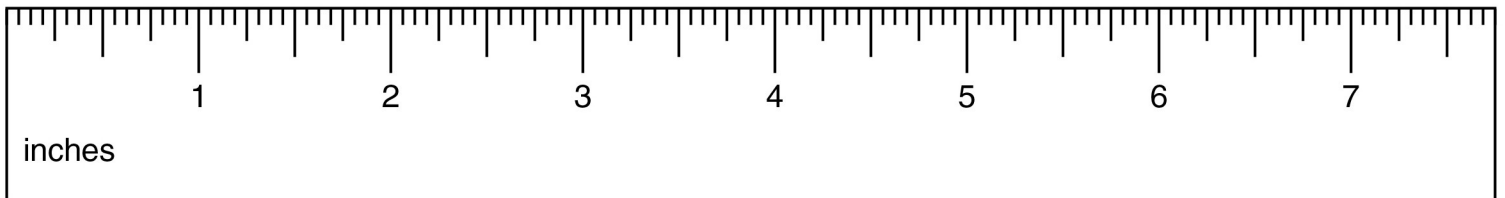

**ÉTAPE / STEP 1**

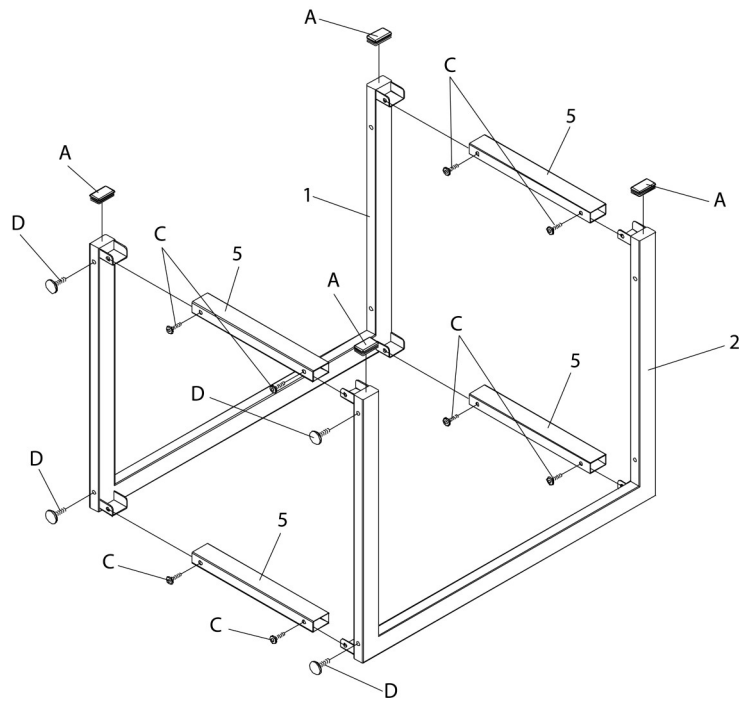

**ÉTAPE / STEP 2**

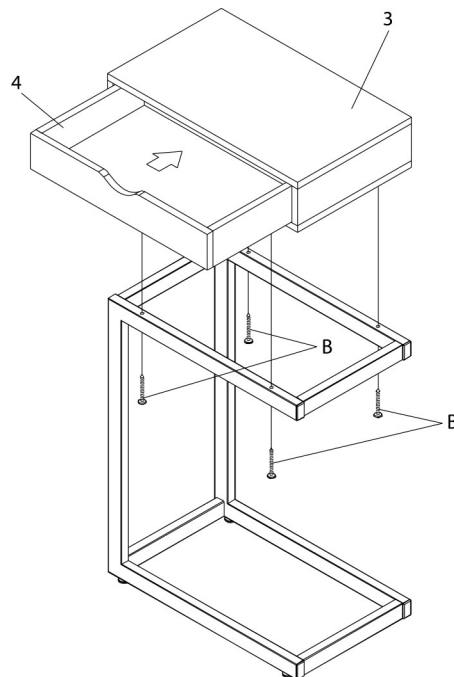

ÉTAPE / STEP 3

