

ASSEMBLY INSTRUCTION





WF320342AABWF320342AAK



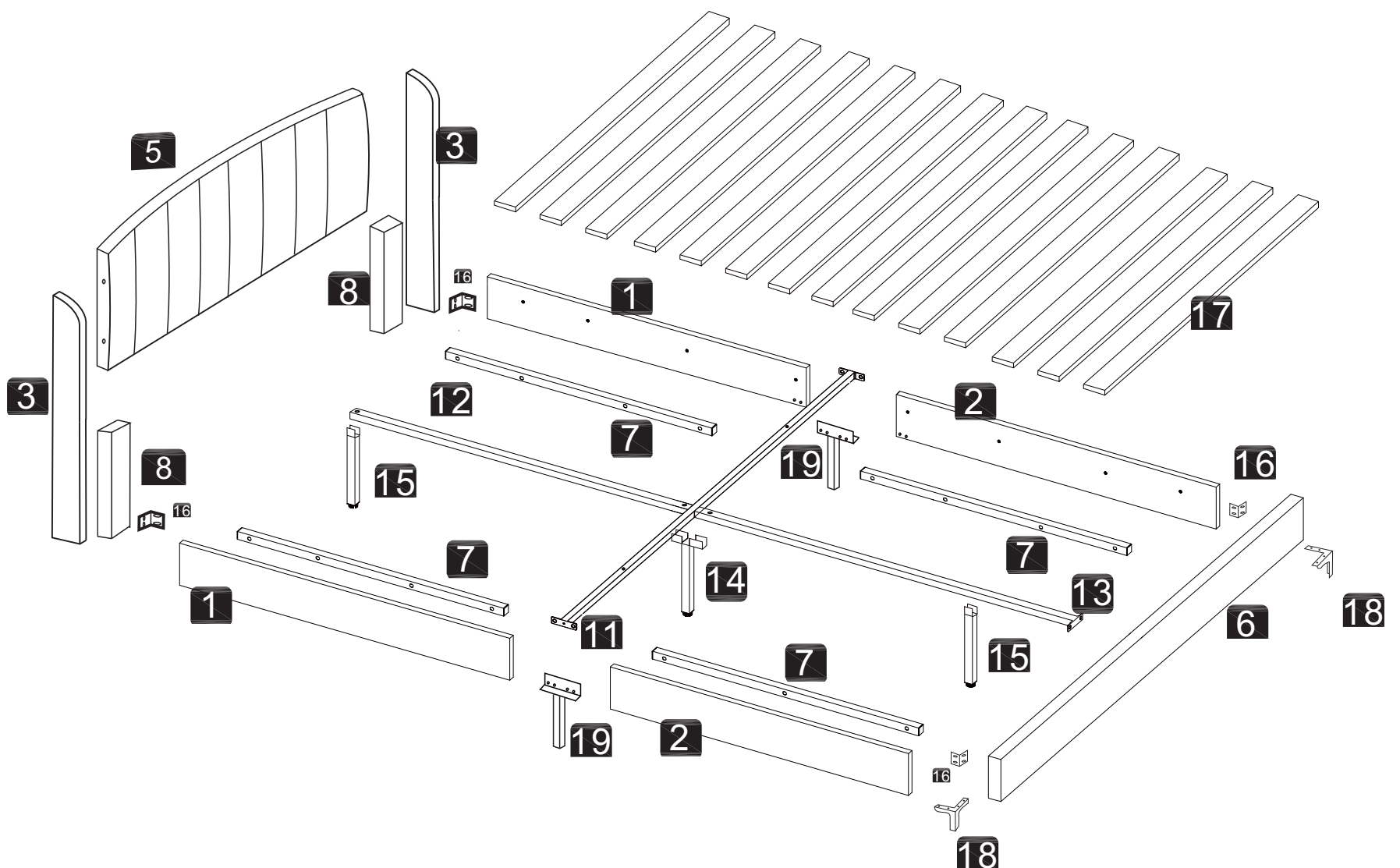

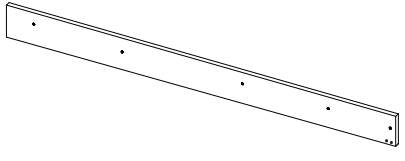
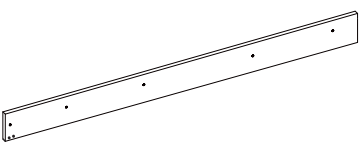

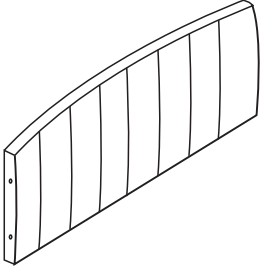
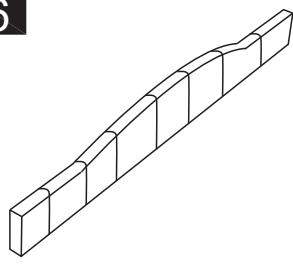
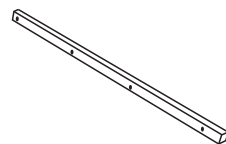
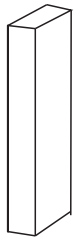
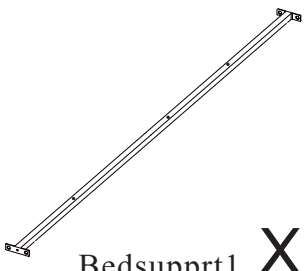
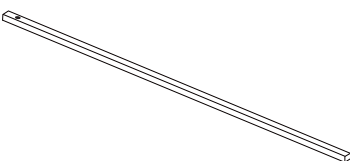
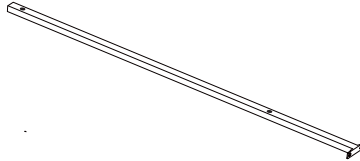
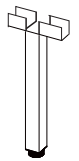
TIPS

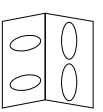
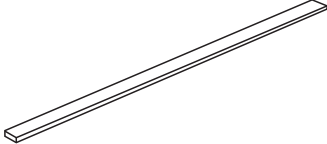
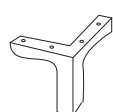
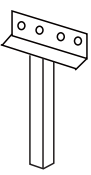
1. Please read the instructions fully before assembly. These instructions include important information which could ensure correct assembly. We have been working on providing high quality products for you. However, in the rare instance that your product is defective, missing parts or there are some issues, please don't hesitate to contact our customer service to submit parts requirements, assembly suggestion, or warranty claims, and we will give the best solution as soon as possible. If necessary, we need you to provide some more clear pictures of the issue.
2. Insert the screws in holes and tighten the screws, but not too tight, 70%~80% is ok, finally tighten all the screws. If some issues happened that some screws can not target to the hole or some parts are difficult to install, please adjust the tightness of the screws.
3. 2 people are recommended to finish

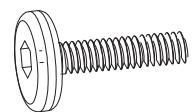
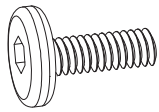
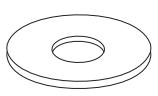

<p>1</p>  <p>Right rear of bedside X2</p>	<p>2</p>  <p>Left rear of bedside X2</p>	<p>3</p>  <p>X1</p>	<p>4</p>  <p>X1</p>
<p>5</p>  <p>on both sides of the bedside X1</p>	<p>6</p>  <p>Bed tail X1</p>	<p>7</p>  <p>Bed side edge strip X4</p>	<p>8</p>  <p>X2</p>
<p>11</p>  <p>Bed support 1 X1</p>	<p>12</p>  <p>Bed support 2 X1</p>	<p>13</p>  <p>Bed support 3 X1</p>	<p>14</p>  <p>Midfoot X1</p>
<p>15</p>  <p>Midfoot X2</p>	<p>16</p>  <p>Bracket X4</p>	<p>17</p>  <p>Skeleton arrangement X14</p>	<p>18</p>  <p>R hardware feet X2</p>
<p>19</p>  <p>Kerb shoe X2</p>			

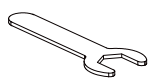
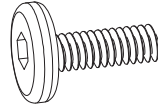
Hardware List

<p>A</p>  <p>Bolts (M8x45mm) X17</p>	<p>B</p>  <p>Bolts (M8x20mm) X30</p>	<p>C</p>  <p>M8 Flat Washer X59</p>	<p>D</p>  <p>Allen Key X1</p>
<p>F</p>  <p>Bolts (M8x40mm) X2</p>	<p>G</p>  <p>X1</p>	<p>H</p>  <p>Bolts (M8x40mm) X13</p>	<p>I</p>
<p>J</p>  <p>M4x25mm X8</p>			

Step 1:

(A)  x6



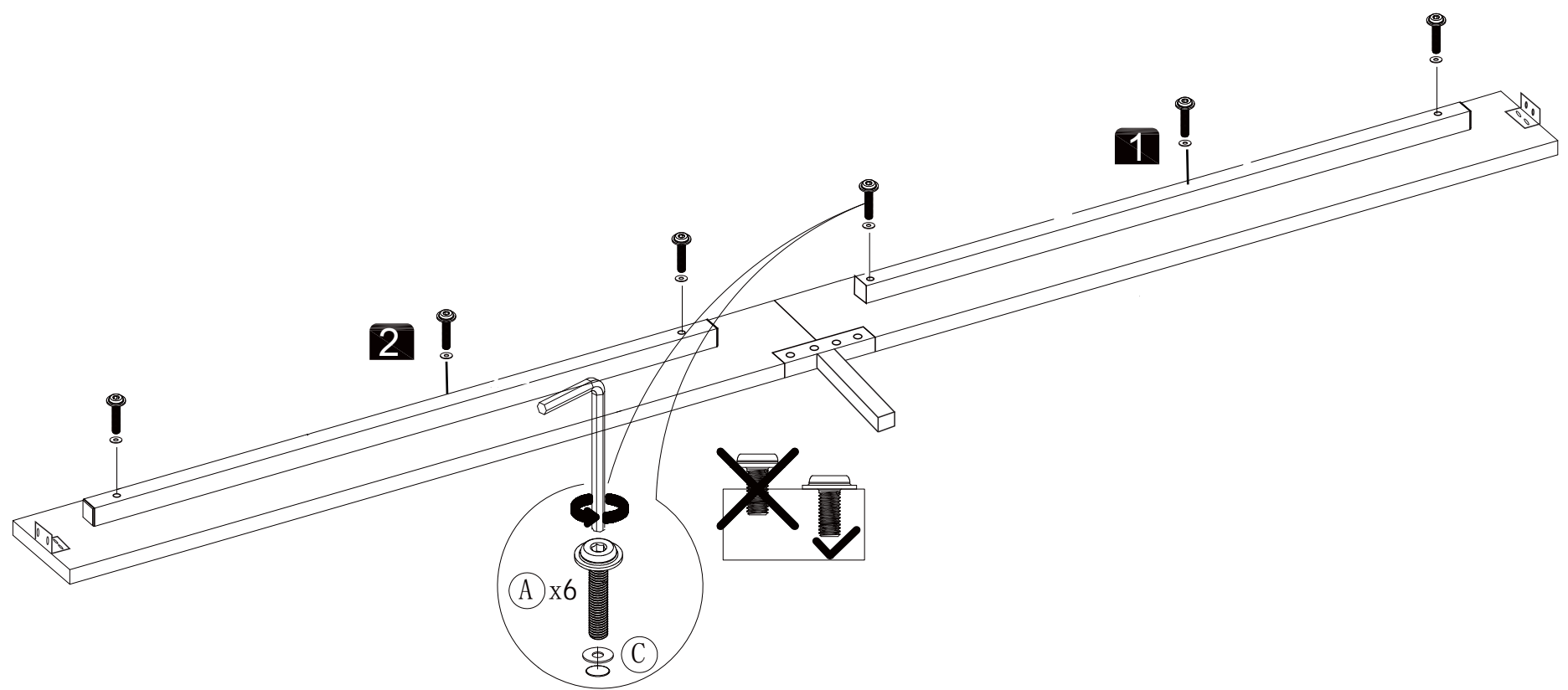
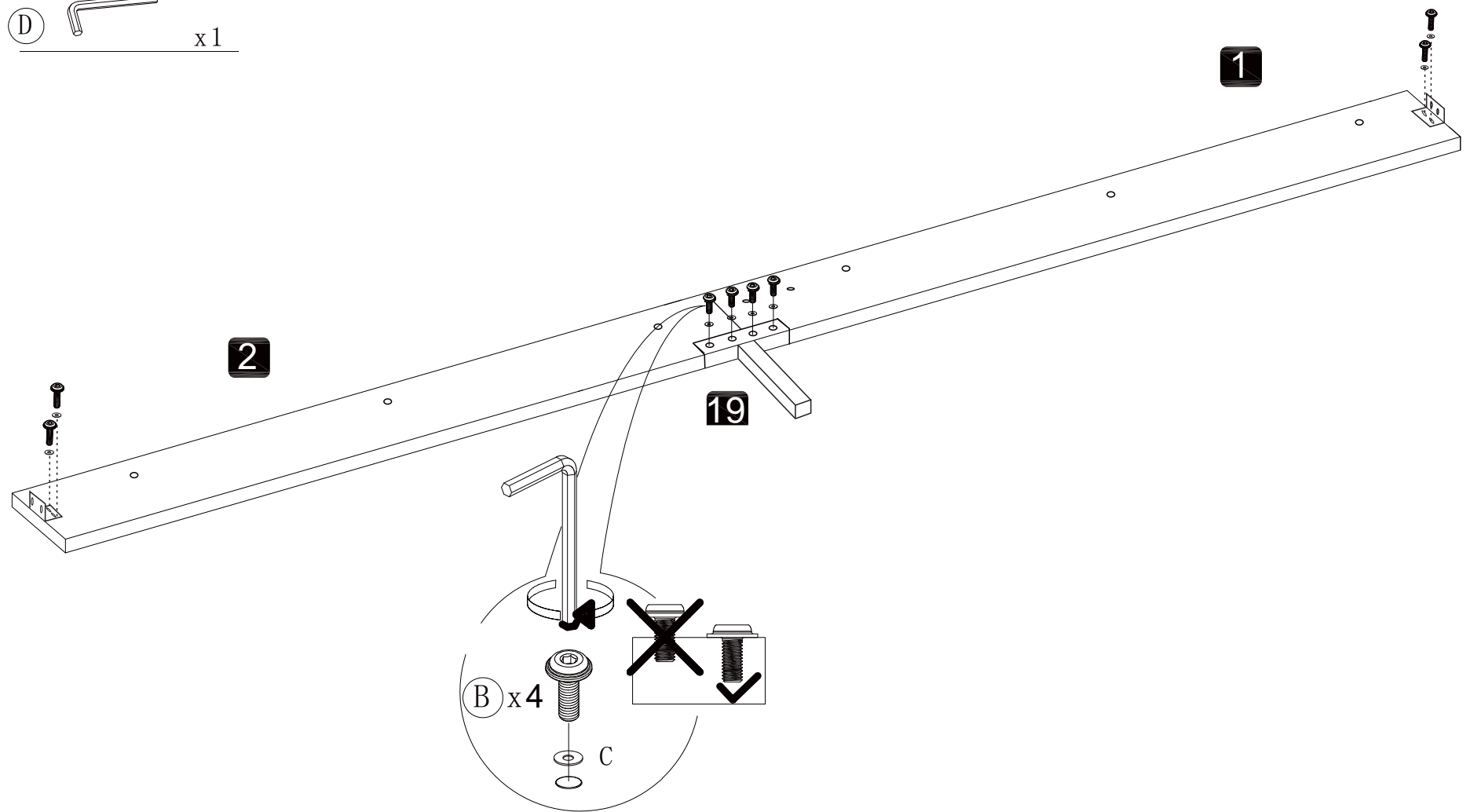

(B)  x8

(C)  x14

(D)  x1

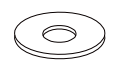

Step2:

- (A)  x6
- (B)  x8
- (C)  x14
- (D)  x1

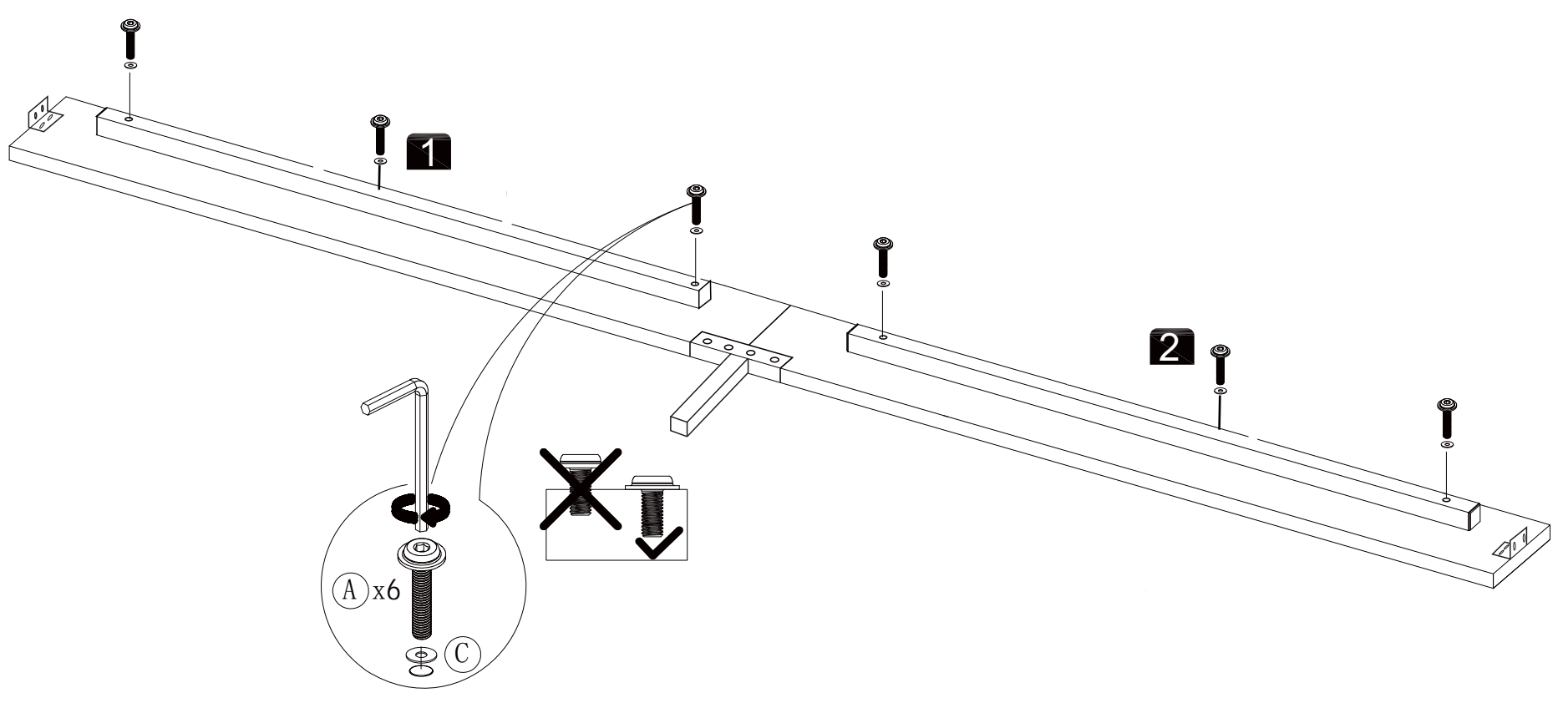
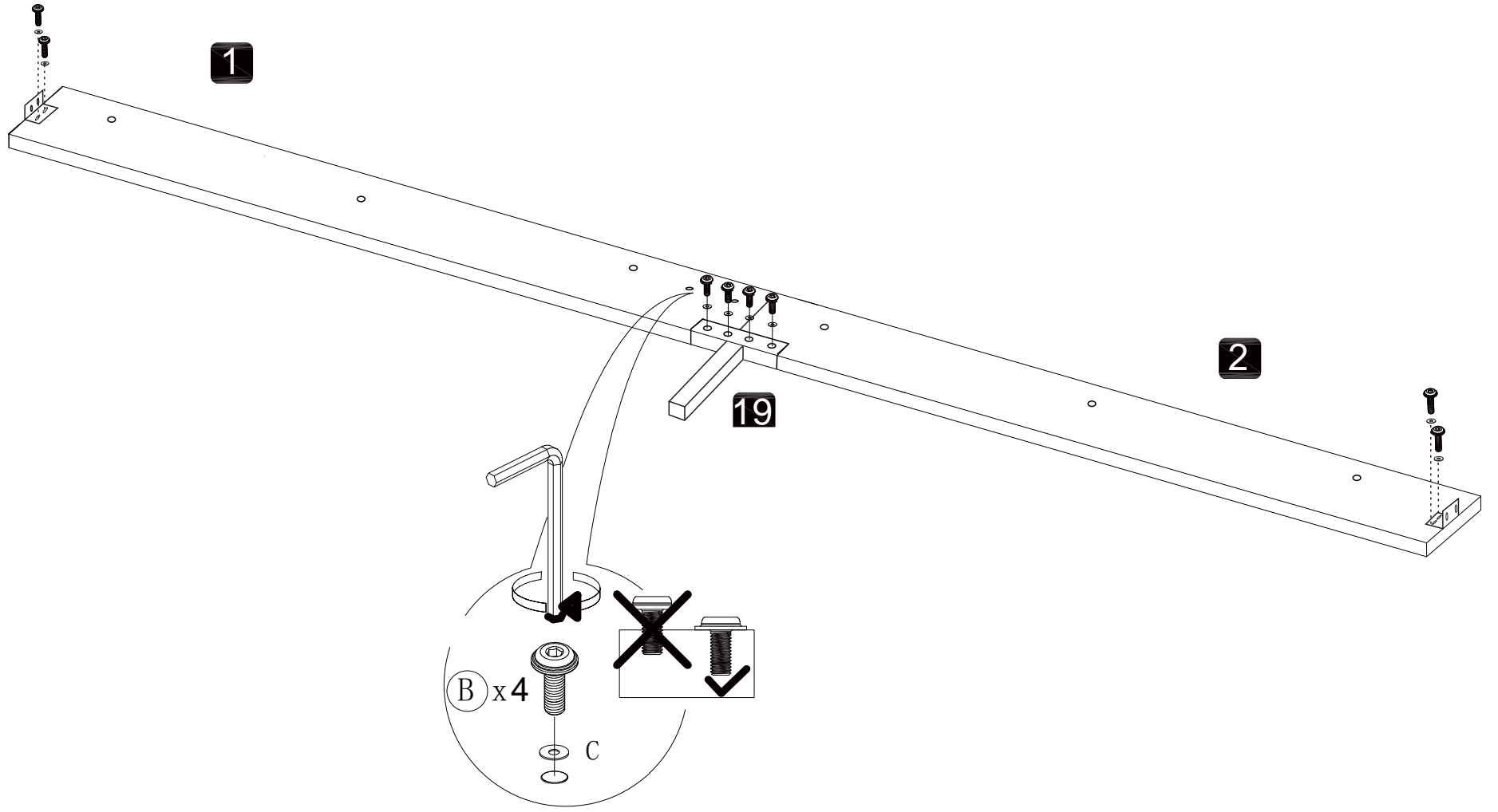



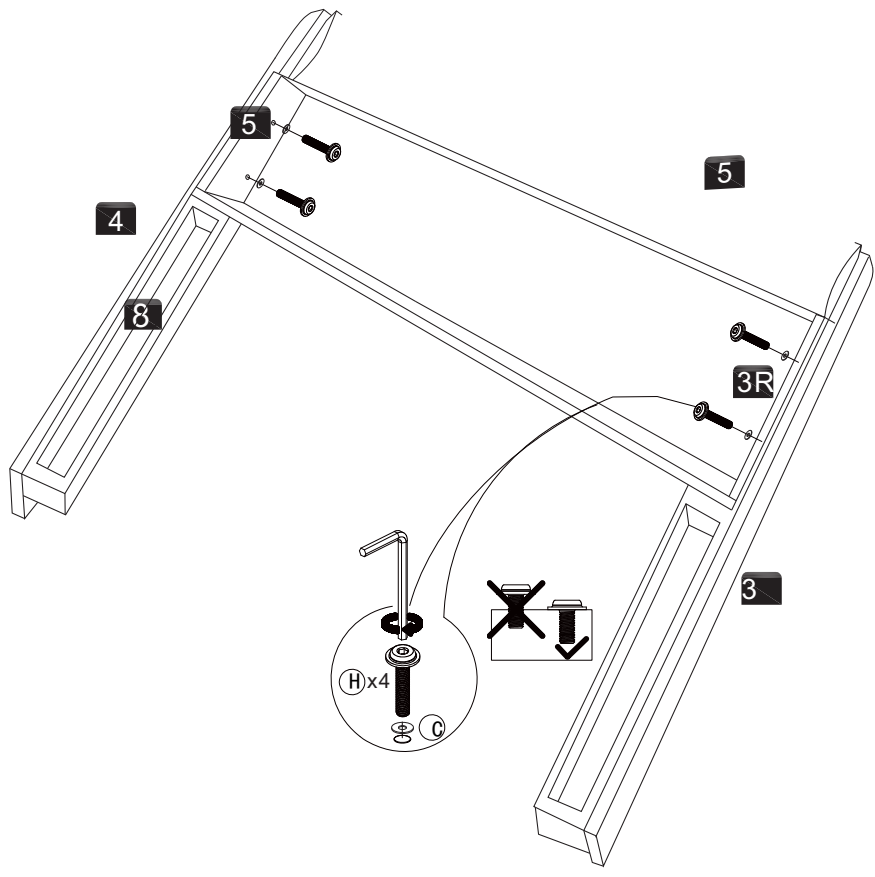
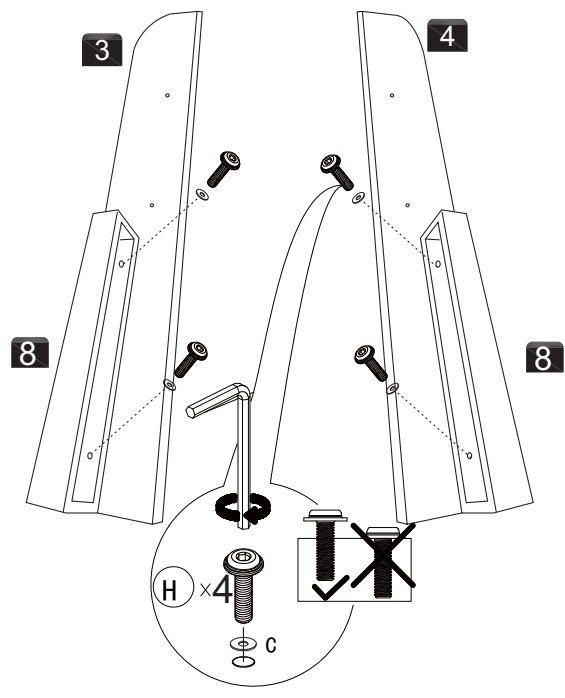

Step3:

H x8

D x1



Step4:

- B**  x4
- C**  x4
- D**  x1
- J**  x8

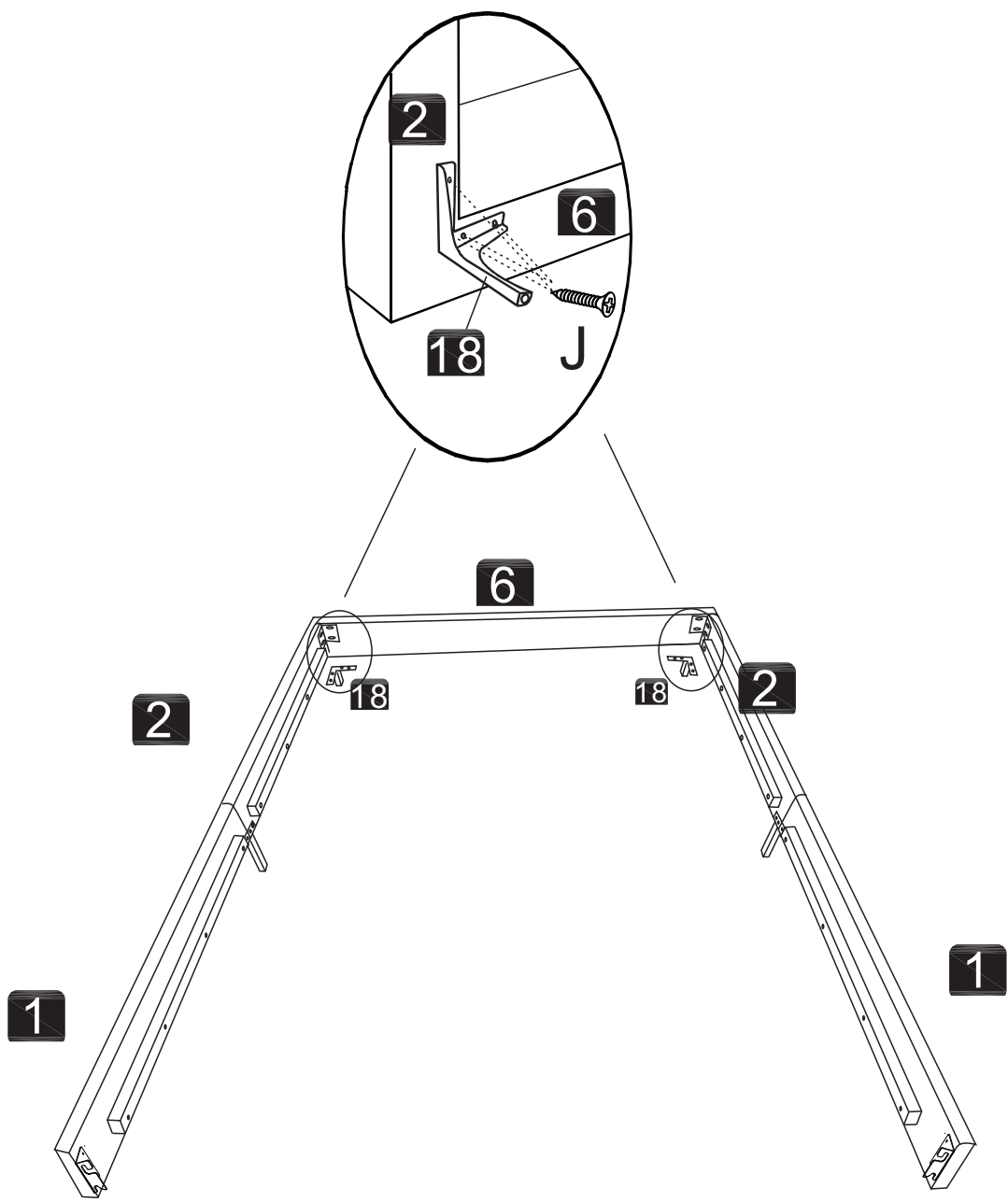
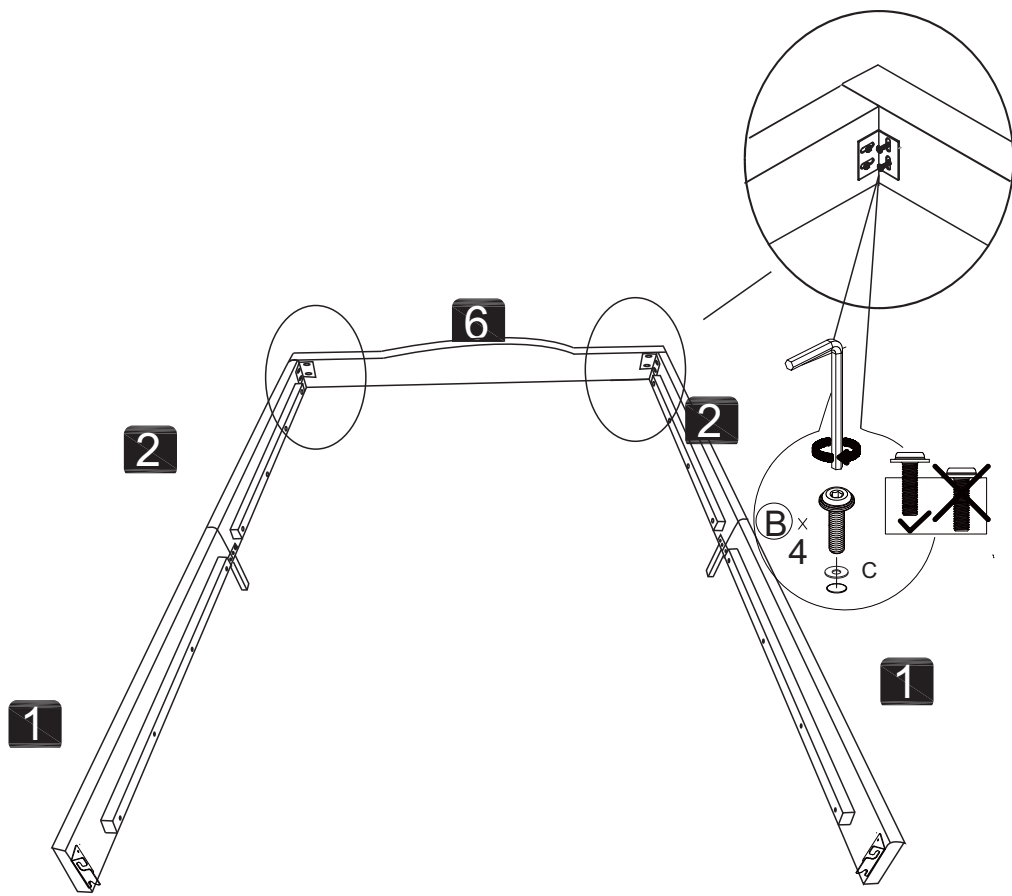

Step 5:

B  x4

C  x4

D  x1

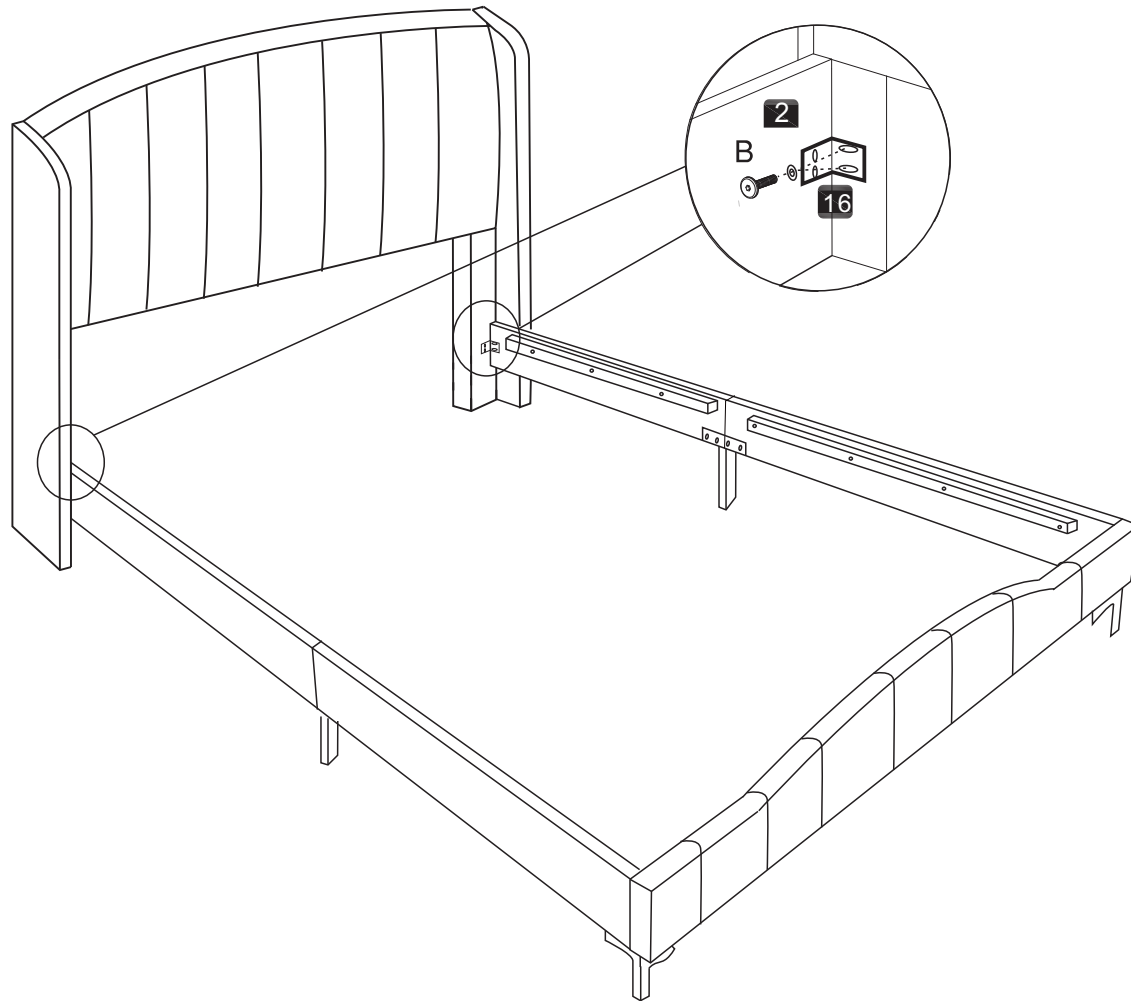



Step 6:

H  x4

F  x2

C  x4

D  x1

G  x1

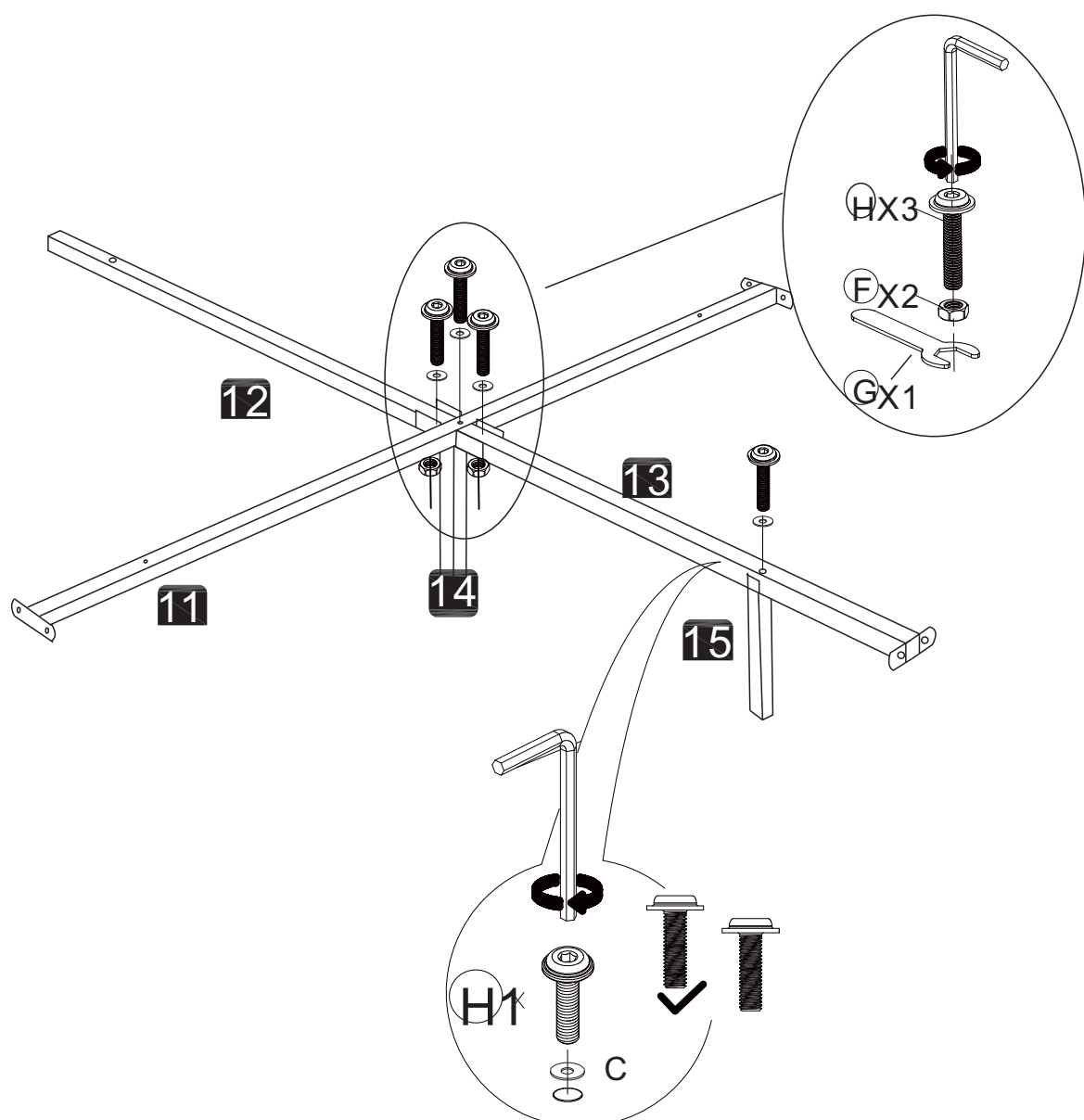

Step 7:

(B)  x6

(C)  x6

(D)  x1

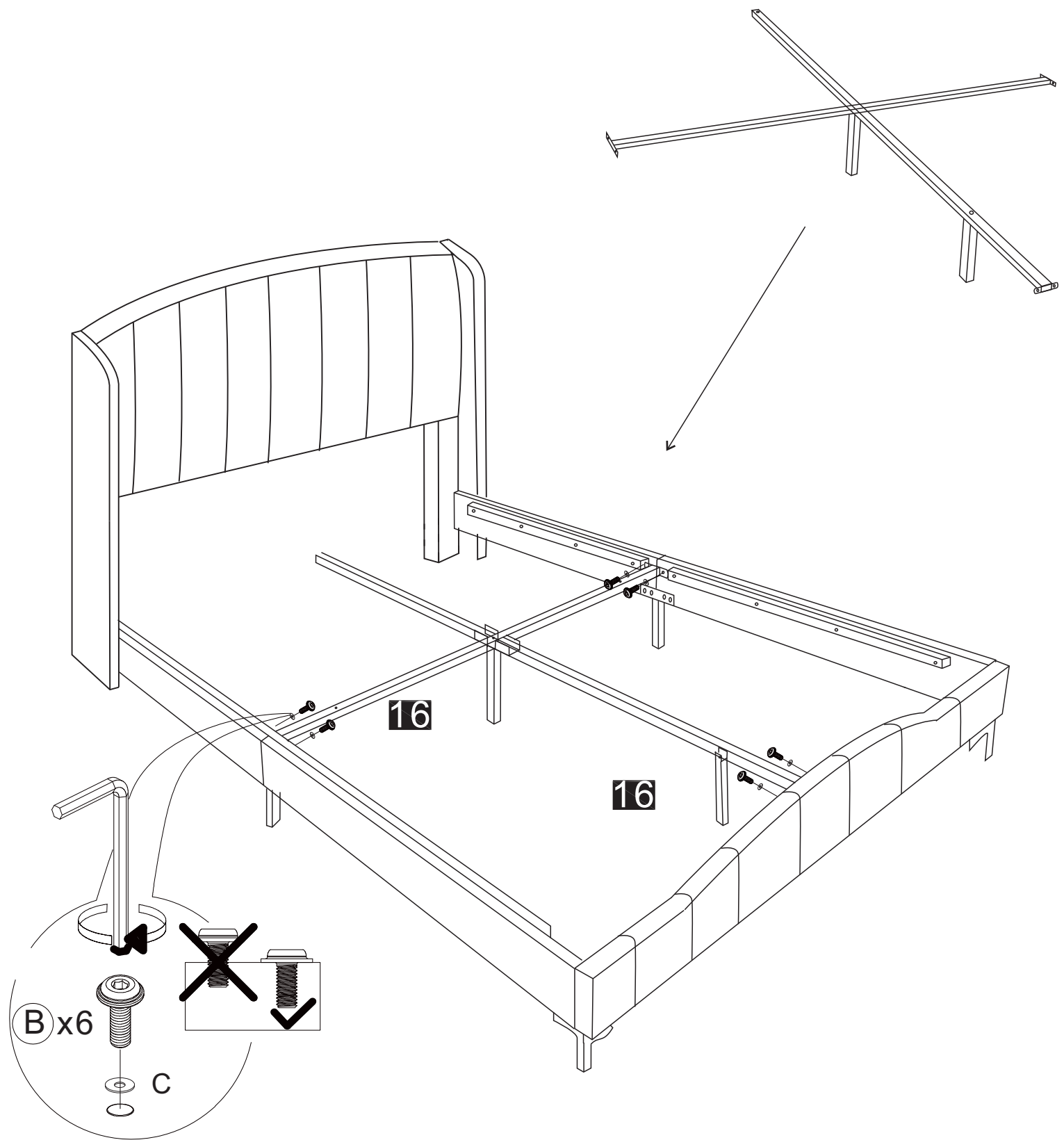

Step 8:

(A)  x1

(C)  x1

(D)  x1

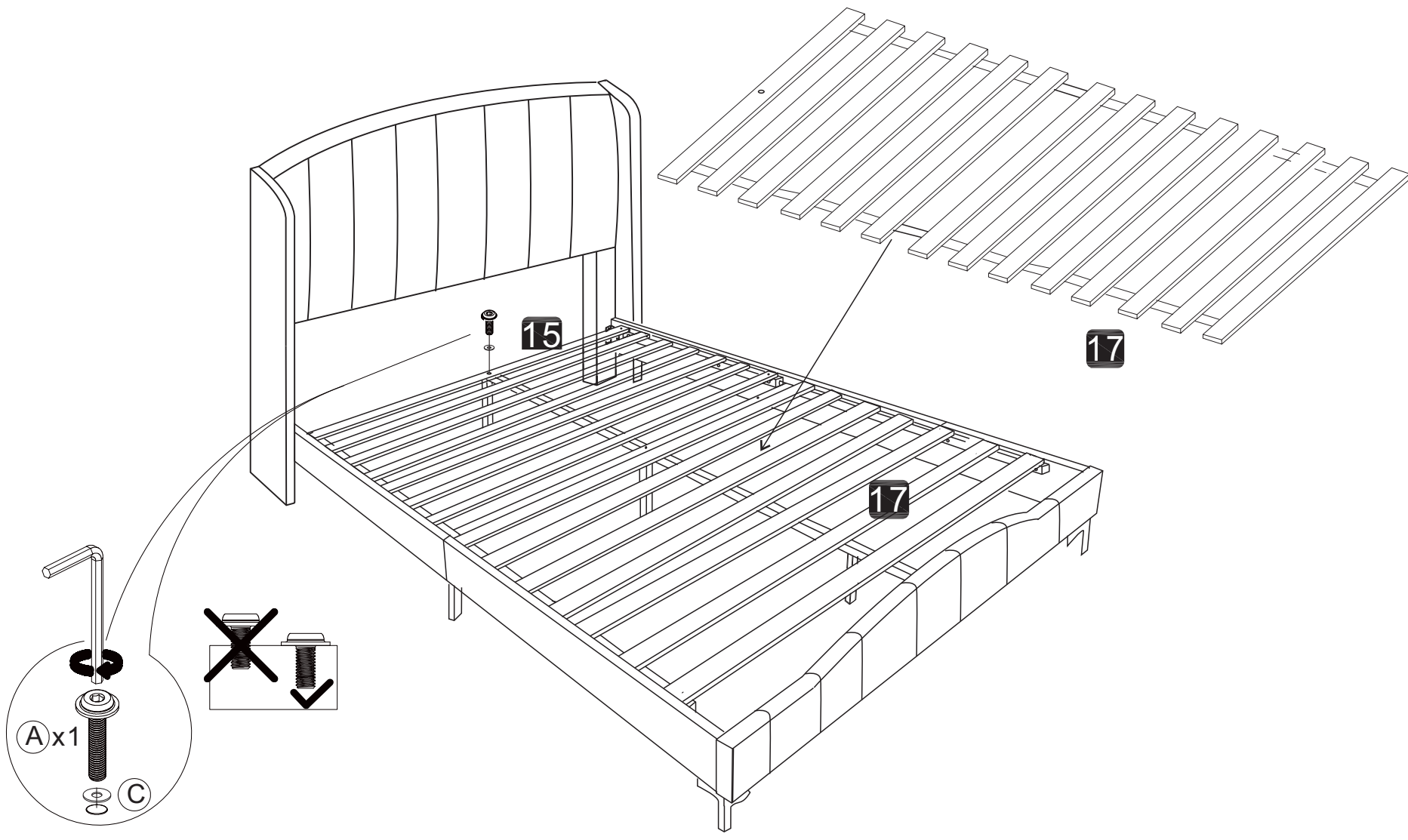

Step 10:

