

# ASSEMBLY INSTRUCTION

## SEATER SOFA

**NOTE: Do not use power tools for assembly. Power tools increase the risk of over tightening which lead to splitting or cracking the wood.**

### COMPONENT LIST

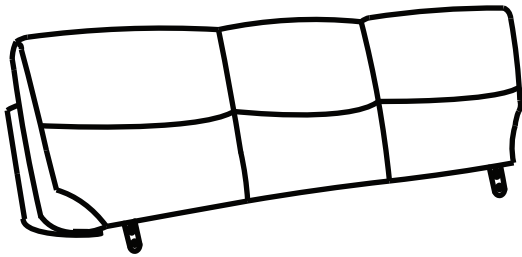



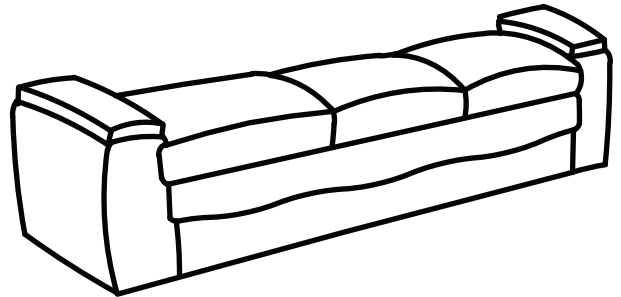

**(A) BACK REST \*1**



**(B) SEAT\*1**



**(C) ARM REST \*2**

| PARTS LIST  |   |          |
|-------------|---|----------|
| Description | Drawings  | Quantity |
| Feet        |  | 4 pcs    |
| Screws      |  | 4 pcs    |
| Washer      |  | 4 pcs    |
| Allen key   |  | 1 pcs    |

**(D) PARTS LIST**

**STEP 1.**

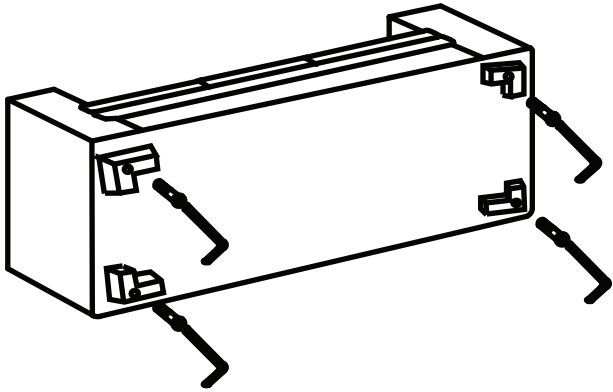

**STEP 2.**

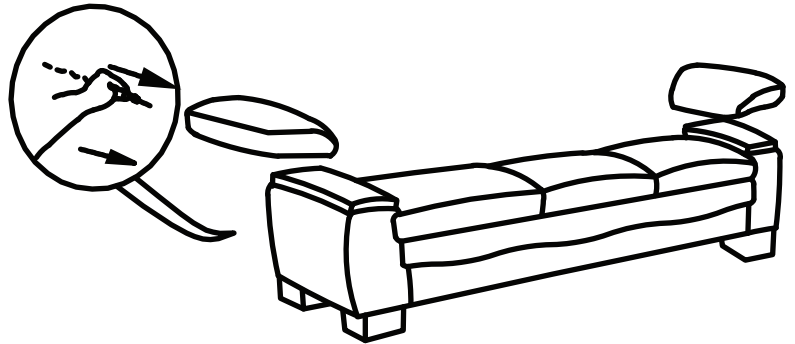

**STEP 3.**

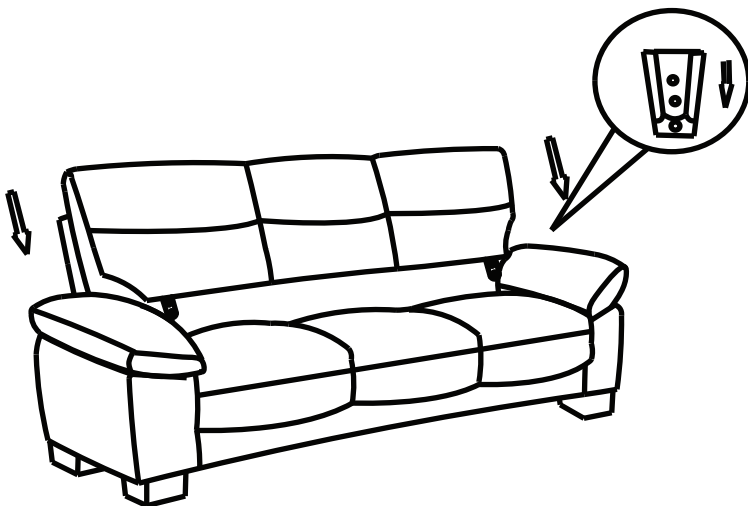

**STEP 4.**

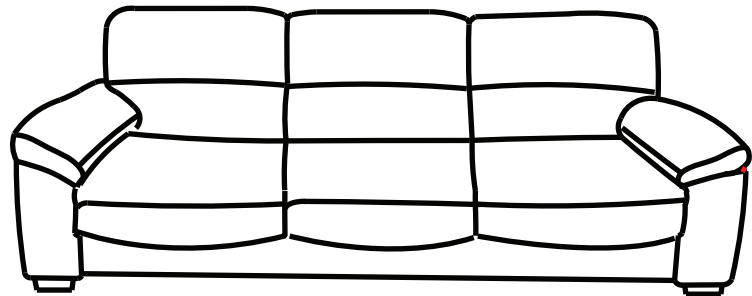

## **CARE INSTRUCTION FOR PU FURNITURE**

- **Avoid exposing furniture directly to sunlight or heating and air conditioning outlets. Exposure to sunlight or heating and air conditioning outlets will fade/damage PU/Fabric**
- **Wipe gently with a damp soft cloth to remove dust, dirt and any grime buildup.**
- **Dry the PU match/ Fabric with a dry soft cloth.**
- **Rub the PU match/ Fabric with professional cleanser.**