

# ASSEMBLY INSTRUCTION

STEP1

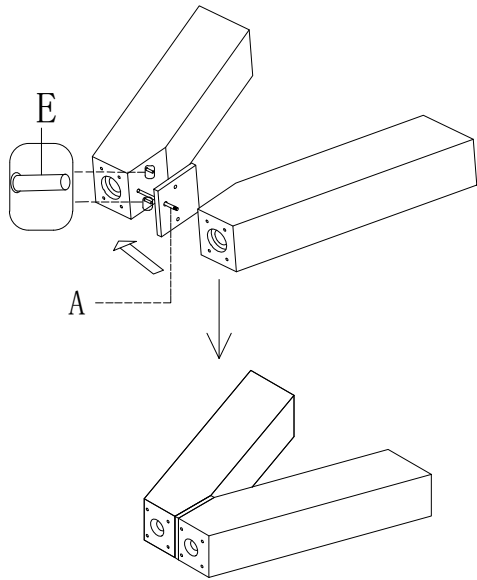

STEP2

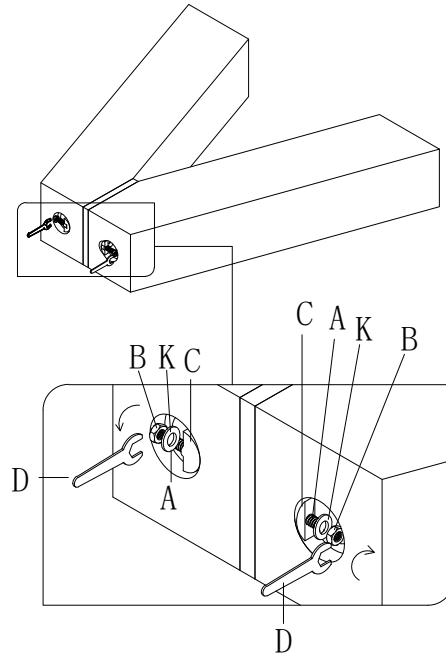



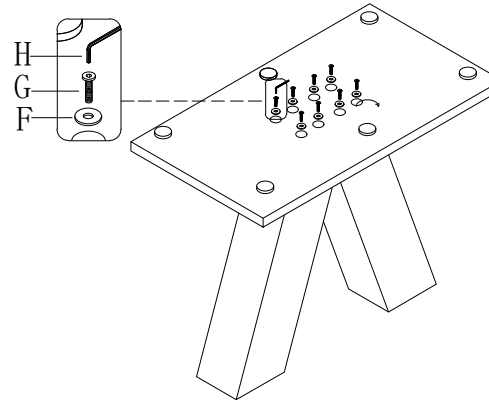



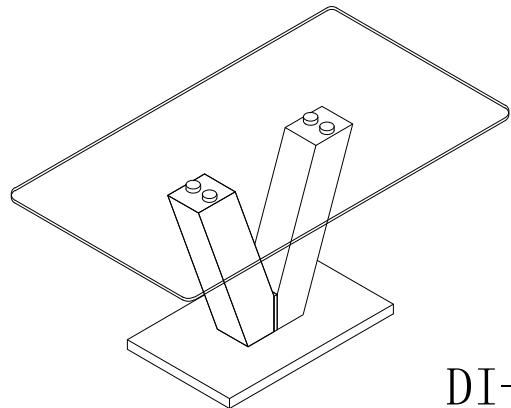
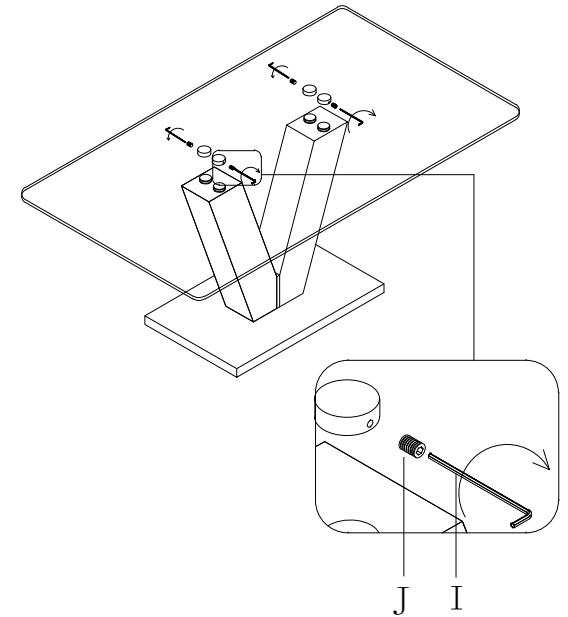



STEP3



STEP 4



DI-20

|   |   |      |   |   |      |
|---|---|------|---|---|------|
| A |  | 1pc  | G |  | 8pcs |
| B |  | 2pcs | H |  | 1pc  |
| C |  | 2pcs | I |  | 1pc  |
| D |  | 2pcs | J |  | 4pcs |
| E |  | 2pcs | K |  | 2pcs |
| F |  | 8pcs |   |   |      |